



**CONTRACT DOCUMENTS &
TECHNICAL SPECIFICATIONS**

PWC2223043

**VARIOUS SEWER MANHOLE REHABILITATION (CIP) –
FIBERGLASS REINFORCED EPOXY**

ISSUED FOR BID

AUGUST 2023

**Fayetteville Public Works Commission
Administrative Building
955 Old Wilmington Road
Fayetteville, NC 28301**



TABLE OF CONTENTS

SECTION A – PROJECT SPECIFICS

General

Advertisement for Bids

00100 – Instructions to Bidders

Bid Submittal Documents

Bid Schedule – Performance and Delivery

Bid Checklist

00300 – Bid Pricing Form

Contractor Qualification Forms

Bid Supplemental Forms and Attachments

Minority, Women, Disadvantaged Business Enterprise (MWDBE) Program

MWDBE Program Forms

SLS Disclosure Form

SECTION B – CONTRACT EXECUTION DOCUMENTS

Notice of Award

Acceptance of Award

On Call Construction Agreement

PWC General Conditions

Contract Supplemental Forms and Attachments

Notice to Proceed

SECTION C – ADMINISTRATIVE PROVISIONS

DIVISION 1 – GENERAL REQUIREMENTS

01000 – Supplementary Conditions

01025 – Measurement and Payment

01300 – Submittals

01400 – Quality Control

01700 – Project Closeout

SECTION D – TECHNICAL SPECIFICATIONS

DIVISION 2 – SITE WORK

02222 - Excavation and Backfilling for Utility Systems *rev 1.1.16*

02272 - Erosion Control - General Provisions

02273 - Temporary Silt Fence

02274 - Gravel Construction Entrance/Exit

02275 - Block and Gravel Inlet Protection *rev 7.1.10*

02500 - Traffic Control

02730 - Sanitary Sewer System *rev 1.1.16*

02750 - Wastewater Flow Control *rev 9.8.19*

02760 - TV Inspection

02764 – Manhole Lining – Fiberglass Reinforced Epoxy

02766 - Sewer Line Cleaning

02831 - Chain Link Fencing

02931 - Lawns and Grasses (Sodding)

02933 - Lawns and Grasses (Seeding)

02934 - Seeding Wetlands

SECTION E – DETAILS

EC.1 General Erosion And Sediment Control Notes

- EC.2 Temporary Gravel Construction Entrance
- EC.3 Silt Fence
- EC.6 Catch Basin Inlet Protection
- M.7 Figure TA-20 Detour For Closed Street
- M.8 Figure TA-10 Lane Closure One Lane Two-Way Traffic
- S.5 Interior Drop Structure Sewer Mains and Laterals

APPENDICES

- Appendix A – Sewer Manhole Rehab Maps
- Appendix B – Chain of Custody Form
- Appendix C – Sales Tax Form

SECTION A – PROJECT SPECIFICS GENERAL

***** THIS PAGE WAS INTENTIONALLY LEFT BLANK *****

**ADVERTISEMENT FOR BID
FAYETTEVILLE PUBLIC WORKS COMMISSION
VARIOUS SEWER MANHOLE REHABILITATION (CIP) – FIBERGLASS REINFORCED
EPOXY**

**Cumberland County
North Carolina**

Pursuant to N.C.G.S 143-129, sealed bids are solicited and will be received at Fayetteville Public Works Commission, Administration Building, Conference Room 107, 955 Old Wilmington Road, Fayetteville, NC 28301, until **1:00 p.m., EST Wednesday, September 13, 2023**, at which time they will be publicly opened and read.

This project consists of rehabilitating existing concrete, brick, and block manholes in various locations across PWC's entire sewer system. Work shall include removal and replacement of rings and covers, installation of chimney seals, installation of water-tight rings and covers, cleaning and preparation of the manhole, installation of the polymeric epoxy manhole lining system, and testing of the new lining system, and all other items necessary to provide a complete project. All work shall be done in accordance with PWC standards and these Contract Documents.

The foregoing description shall not be construed as a complete description of all work required.

A **MANDATORY** pre-bid meeting will be held at **1:00 p.m., EST Tuesday, August 22, 2023**, in the Skills Lab, Fayetteville Public Works Commission, Administrative Building, 955 Old Wilmington Road, Fayetteville, NC 28301. Representatives of the Owner and Engineer will be available to answer questions. Any formal bid submitted by a Bidder that fails to attend this meeting will be considered an unresponsive bid.

Questions will be fielded at the pre-bid meeting and all prospective bidders are required to attend the meeting. Individual telephone inquiries are prohibited. PWC assumes no responsibility to fully inform absentees of clarifications not issued by addendum.

Bids must be enclosed in a sealed envelope addressed to Victoria McAllister, Senior Procurement Advisor, Fayetteville Public Works Commission, 955 Old Wilmington Road, Fayetteville, North Carolina 28301. The outside of the envelope must be marked **SEALED BID: VARIOUS SEWER MANHOLE REHABILITATION (CIP) – FIBERGLASS REINFORCED EPOXY** and shall indicate the name, address and state license number of the bidder. Bids shall be submitted on the printed forms, or exact copies thereof, contained in the Contract Documents.

Each bid shall be accompanied by a bid bond of five percent (5%) of the bid executed by a surety company licensed under the laws of North Carolina to execute the Contract in accordance with the bid bond and upon failure to forthwith make payment, the surety shall pay the obligee an amount equal to the amount of said bond. Said deposit shall be retained by the Owner as liquidated damages in event of failure of the successful bidder to execute the Contract within ten (10) days after the Notice of Award or give satisfactory surety as required by law.

Performance and Payment Bonds are required in the amount of 100% of the Contract amount and shall be furnished by the Contractor.

VARIOUS SEWER MANHOLE REHABILITATION (CIP) – FIBERGLASS REINFORCED EPOXY

All Contractors are notified that North Carolina Statutory provisions as to licensing of Contractors will be followed as applicable in receiving and evaluating bids and in reading and awarding the Contract (Chapter 87 of the North Carolina General Statutes).

The license classification shall be:

Part 1:	Public Utilities (Water and Sewer)	-	Unlimited
	Unclassified	-	Unlimited

Specifications including Contract Documents will be available online for viewing and downloading on or about **Monday, August 7, 2023** on the PWC Procurement website at <https://www.faypwc.com/purchasing>. In addition, the documents will be available from the Fayetteville State University Construction Resource Office (FSU CRO) at <https://www.uncfsu.edu/academics/colleges-schools-and-departments/broadwell-college-of-business-and-economics/outreach-centers/construction-resource-office>. In collaboration with the North Carolina Institute of Minority Economic Development, the FSU CRO offers services and support to help small, minority, veteran, and women-owned businesses identify and compete for construction-related projects.

At the FSU CRO, potential bidders may:

- Research, view and print project drawings to scale free of charge;
- Use available software to prepare their bid; and
- Receive certification and pre-qualification assistance.

Please email the FSU CRO to make an appointment: fsucro@uncfsu.edu

Specifications are also being furnished to ISQFT (www.isqft.com) for online posting. Purchase of the documents is not required to bid.

Fayetteville Public Works Commission reserves the right to reject any or all bids for any reason determined by PWC to be in its best interest, or to award the bid to the lowest responsible bidder or bidders, taking into consideration quality, performance, and the time specified in the bids for the performance of the contract.

The bidder to whom the contract may be awarded must comply fully with the requirements of North Carolina General Statutes Section 143-129, as amended.

No bids may be withdrawn after the scheduled Bid Opening for a period of ninety (90) calendar days.

FAYETTEVILLE PUBLIC WORKS COMMISSION
Candice S. Kirtz
Director of Supply Chain

**00100 - INSTRUCTIONS TO BIDDERS
FAYETTEVILLE PUBLIC WORKS COMMISSION
VARIOUS SEWER MANHOLE REHABILITATION (CIP) – FIBERGLASS REINFORCED
EPOXY**

A. DEFINED TERMS

Terms used in these Instructions to Bidders are defined in the Definitions and Terminology sections of PWC General Conditions.

B. COPIES OF BIDDING DOCUMENTS

1. Complete sets of the Bidding Documents as stated in the Invitation to Bidders, may be obtained from the PWC Procurement Department.
2. Complete sets of Bidding Documents shall be used in preparing Bids. PWC assumes no responsibility for errors or misinterpretations resulting from the use of incomplete sets of Bidding Documents.

C. EXAMINATION OF CONTRACT DOCUMENTS, OTHER RELATED DATA, AND PROJECT SITE

1. Before submitting a Bid, each Bidder shall (a) examine the Contract Documents thoroughly, (b) visit the site and become familiar with the site and any local conditions that may in any manner affect the cost, progress, or performance of the Work, (c) be familiar with federal, state and local laws, ordinances, rules and regulations that may in any manner affect cost, progress or performance of the Work, and (d) study and carefully correlate Bidder's observations with the Contract Documents, and (e) give the PWC Procurement Advisor written notice of all conflicts, errors or discrepancies in the Contract Documents.
2. Bidders should consult the Specifications for the identification of those reports of investigations and tests of subsurface and latent physical conditions at the site or reports that otherwise may affect cost, progress, or performance of the Work which may have been utilized in the preparation of the Drawings and Specifications. PWC will make copies of such reports if available at the cost (non-refundable) of reproduction to any Bidder requesting them. These reports are not intended to constitute any explicit or implicit representation as to the nature of the subsurface and latent physical conditions, which may be encountered at the site or to constitute explicit or implicit representations as to any other matter, contained in any report. Such reports are not guaranteed as to accuracy or completeness and are not part of the Contract Documents. Before submitting a Bid, each Bidder will, at its own expense, make such investigations and tests as the Bidder may deem necessary to determine his Bid for the performance of the Work in accordance with the Contract Documents.
3. On request (minimum 48 hours advance notice), PWC will provide each Bidder access to the site to conduct such investigations and tests, as each Bidder deems necessary for submission of its Bid.
4. The lands upon which the Work is to be performed, right-of-way for access thereto, and other lands available for use by the Contractor in performing the Work are identified in the

Contract Documents.

5. The submission of a Bid constitutes an incontrovertible representation by the Bidder that it has complied with every requirement of this Section and that the Contract Documents are sufficient in scope and detail to indicate and convey an understanding of all terms and conditions for the performance of the Work.

D. INTERPRETATIONS AND ADDENDA

1. All questions about the meaning or intent of the bid or Contract Documents shall be submitted in writing to Victoria McAllister, Senior Procurement Advisor, by email to victoria.mcallister@faypwc.com. In order to receive consideration, questions must be received by 5:00 p.m., EST Friday, September 1, 2023. Any interpretations of questions so raised, which in the opinion of the Engineer require interpretations, will be issued by Addenda via email or posted online by the Owner and/or Project Engineer. An Addendum extending the Bid Opening date may be issued up to five (5) business days before the Bid Opening date. An Addendum withdrawing the Invitation for Bid may be issued any time prior to the Bid Opening date. The Owner and Engineer will not be responsible for oral interpretations or clarifications, which anyone presumes to make on their behalf.

Bidders are expressly prohibited from contacting any PWC official or employee associated with this project, except as noted above. Violation of this prohibition is grounds for the immediate disqualification of the bidder.

2. PWC may issue such additional Addenda as may be necessary to clarify, correct, or change the Contract Documents. Such Addenda, if any, will be issued in the manner and within the time stated in Paragraph 1 of this Section.
3. Each Bidder shall be responsible for determining that all Addenda issued by PWC have been received before submitting a Bid for the Work.
4. Each Bidder shall acknowledge the receipt of each Addendum on the Bid Form.

E. SUBSTITUTE MATERIAL AND EQUIPMENT

The Contract, if awarded, will be on the basis of material and equipment described in the Drawings or required in the Specifications without consideration of possible substitute or "or-equal" items. The procedure for submittal of substitute or "or-equal" items for consideration is set forth in the PWC General Conditions.

F. CONTRACTOR'S LICENSE

1. No General Contractor shall engage in contracting work in the State of North Carolina unless it has been licensed under in accordance with North Carolina law.
2. Bidders are prohibited from contracting for, or bidding upon, the construction, removal, repair or improvements to or upon real property owned, controlled or leased by Fayetteville Public Works Commission without a North Carolina Contractor's License.
3. Each bidder shall indicate its North Carolina Contractor's License number on the bid envelope and the Bid Form.
4. License Classification shall be:

- Public Utilities Water and Sewer: Unlimited
- Unclassified: Unlimited

G. SUBCONTRACTORS

1. Contractor shall subcontract no more than 49 percent (49%) of the value of the Contract.
2. Each Bidder shall submit to PWC with its bid the List of Subcontractors, Suppliers, other persons, and organizations proposed for those portions of the Work for which such identification is required. If PWC, after due investigation has reasonable objection to any proposed Subcontractor, Supplier, other person or organization, PWC may, before Notice of Award is given, request apparent Successful Bidder to submit an acceptable substitute without an increase in the Bid.
3. If the apparent Successful Bidder declines to make such a substitution, PWC may award the Contract to the next lowest responsive, responsible Bidder that proposes to use acceptable Subcontractors, Suppliers, and other persons, and organizations. The declining to make requested substitutions will not constitute grounds for sacrificing the bid security of any Bidder. If PWC does not make written objection to a Bidder's list of Subcontractors, Suppliers, other persons, or organizations prior to giving Notice of Award, the list will be considered acceptable, subject to revocation as provided in the PWC General Conditions.

H. MINORITY, WOMEN, DISADVANTAGE BUSINESS ENTERPRISE (MWDBE) PROGRAM/ SMALL LOCAL SUPPLIER (SLS) PROGRAM

1. PWC is committed to promoting the utilization of Minority, Women, and Disadvantaged Businesses in PWC's geographical statistical area (GSA) by providing equal opportunity for participating in all aspects of PWC's contracting and procurement programs. The GSA consists of NCDOT division areas 3-8, and 10. PWC is also committed to promoting the utilization of small, local businesses in the Fayetteville Metropolitan Statistical Area (MSA) by increasing opportunities for those businesses to participate in PWC procurements. The MSA consists of Cumberland County, Hoke County, and Harnett County.
2. PWC requires Bidders to report efforts to utilize Minority, Women, and Disadvantaged Business Enterprises (MWDBEs) and Historically Underutilized Businesses (HUBs) for specific projects and requires all Bidders to report all such efforts for MWDBEs, HUBs, and Small Local Suppliers regardless of the requirements of a specific project. Bidders shall document any good-faith efforts and utilization in the MWDBE forms provided within the Contract Documents.
3. NCDOT Disadvantaged Business Enterprise (DBE) and NC Department of Administration (DOA) Historically Underutilized Business (HUB) firms with current certifications are acceptable for listing in the bidder's submittal of MWDBE participation and will be considered to meet any necessary contract goal. Firms that are certified through NCDOT are listed in the "Vendor Directory" which can be accessed through the following: <https://www.ebs.nc.gov/VendorDirectory/default.html>. Firms that are certified through NC DOA are listed at the "HUB Vendor Search" which can be accessed through the following. <https://www.doa.state.nc.us/HUB/searchhub.html>.

4. Bidders shall submit, with their bid, the MWDBE documentation required in the Contract Documents. The Bidder is strongly recommended to attend the Pre-Bid Meeting, as important information will be reviewed.

I. SUBMISSION OF BIDS

1. All Bidders shall use the enclosed Bid Forms, or exact copies thereof, in submitting their bid prices. PWC will not accept oral Bids or Bids received by telephone, email, or telecopier (FAX machine) for this Bid.
2. All prices must be F.O.B. delivered to the point as indicated by this Bid. PWC will grant no allowance for boxing, crating, or delivery unless specifically provided for in this Bid.
3. The Bid Form must be completed in black ink. Black or blue pen ink is acceptable if handwritten. Discrepancies between amounts shown in words and amounts shown in figures will be resolved in favor of the amounts shown in words. Discrepancies in the multiplication of units of Work and the unit prices will be resolved in favor of the correct multiplication of the unit prices. Discrepancies between the indicated sum of any column of figures and the correct sum thereof will be resolved in favor of the correct sum.
4. Bid submittals sent by mail should be registered mail. The sealed Bid, marked as indicated above, should be enclosed in an additional sealed envelope similarly marked and addressed to:

Fayetteville Public Works Commission
Attn: Victoria McAllister, Senior Procurement Advisor
955 Old Wilmington Road
Fayetteville, North Carolina 28301

5. Mark the envelope in the lower left-hand corner with the project title, hour and due date of Bid, and the Bidder's North Carolina contractor registration number.
6. Bids sent by mail and arriving after the time for the opening of Bids shall not be considered valid Bids. In such instances, the Bidders shall have no claim against PWC.
7. All items contained in the Bid Checklist shall be completely filled out and submitted with the bid. Failure to submit any of the items requested with the Bid Form may be just cause for rejection of the Bid by PWC.
8. All erasures, insertions, additions, and other changes made by the Bidder to the Bid Form shall be signed or initialed by the Bidder. Bids containing any conditions, omissions, erasures, alterations, or items not called for in the Bid, may be rejected by PWC as being incomplete or nonresponsive.
9. The Bid Form must be signed in order to be considered. If the Bidder is a corporation, the Bid must be submitted in the name of the corporation, not simply the corporation's trade name. In addition, the Bidder must indicate the corporate title of the individual signing the Bid.
10. The Bid Form, the Bid security, if any, and any other documents required, shall be enclosed in a sealed opaque envelope. Any notation or notations on the exterior of the envelope purporting to alter, amend, modify, or revise the bid contained within the

envelope shall be of no effect and shall be disregarded.

11. All Bids received in the Procurement Department by the deadline indicated will be kept sealed until the time and date of the Bid Opening.
12. All late Bids shall be returned unopened to the sender.

J. BID BOND

1. Each Bid shall be accompanied by an acceptable Bid bond in the amount of five percent (5%) of the Bid amount, and made payable to Fayetteville Public Works Commission, North Carolina.
2. The Bid bond is a guarantee that if the contract is awarded by PWC to the Bidder, the Bidder shall enter into the contract with PWC for the work mentioned in this Bid or forfeit the Bid bond to PWC, not as a penalty, but as liquidated damages.
3. No forfeiture under a Bid bond shall exceed the lesser of (a) the difference between the Bid for which the Bid bond was written and the next low Bid of another Bidder, or (b) the face amount of the Bid bond.
4. All bonds shall be executed by a surety company selected by the Bidder, which is legally authorized to do business in the State of North Carolina (NCGS §44 A-26), and the bond shall be the same in both form as well as substance as AIA Document A310, Bid Bond.
5. The Bidder shall require the attorney-in-fact, who executed the required bond on behalf of the surety company, to affix thereto a certified and current copy of the power of attorney.
6. The bond premium shall be paid by the Bidder and the cost shall be included in the Bid price.
7. Any inspection of procurement transaction records shall be subject to reasonable restrictions to ensure the security and integrity of the records.

K. OPENING OF BIDS

1. Bids will be opened publicly and read aloud on the date and time set for the Bid Opening in the Notice to Bidders.
2. Any Bidder, upon request, shall be afforded the opportunity to inspect Bid records within a reasonable time after the opening of all Bids but prior to award, except in the event that PWC decides not to accept any of the Bids and to reopen the contract. Otherwise, bid records shall be open to public inspection only after the award of the Contract.
3. Any inspection of procurement transaction records shall be subject to reasonable restrictions to ensure the security and integrity of the records.

L. MODIFICATION OF BIDS

1. A Bid may be modified or withdrawn by the Bidder at any time prior to the time and date set for the Bid Opening. The Bidder shall notify the PWC Procurement Department in writing of its intentions.
2. Modified and withdrawn Bids may be resubmitted to the PWC Procurement Department

up to the time and date set for the Bid Opening.

M. WITHDRAWAL OF BID DUE TO ERROR

1. If the Bidder desires to withdraw its Bid, the Bidder must do so before the time fixed for the opening, without prejudice, by communicating its purpose in writing to PWC. After bids are open, bids may only be withdrawn in strict accordance with N.C.G.S. Section 143-129-1

N. BIDS TO REMAIN OPEN

1. All Bids shall remain open for ninety (90) calendar days after the day of the Bid Opening.
2. PWC is aware of the current market volatility and supply chain issues. Therefore, PWC is willing to evaluate the material prices at the time of bid versus time the Contract is executed and consider compensation to address increased material costs that may be unknown at the time of the bid. This evaluation will only be considered for CIP lining materials (cementitious material, fiberglass reinforcement and epoxy) and will be conducted in the following manner:
 - a. At the time the contract is executed, the contractor may request a unit price cost adjustment, for CIP lining related items only (cementitious material, fiberglass reinforcement and epoxy) based on the most recently published Engineering News Record Construction Cost Index. The price increase will be equal to the percent increase in the ENR Construction Cost Index, not to exceed 5%. PWC shall receive the Contractor's request for a unit price adjustment no later than 30 days after the Notice to Proceed will result in the contract being renewed at the same unit prices.

O. UNIT PRICING

1. All unit prices submitted herein shall be firm against any increase for the initial one-year contract period.
2. If the contract is renewed for an additional contract period, the Contractor may request that each unit price be increased/decreased, based on the most recently published Engineering News Record Construction Cost Index for the annual change, not to exceed 3.00% whichever is lower. PWC shall receive the Contractor's request for a unit price adjustment no later than 15 days prior to the end of contract year. Failure to submit the request by this time will result in the contract being renewed at the same unit prices.
3. The request for increase may be submitted with the PWC reserve the right to accept or reject the increase or cancel the Contract. Such action by PWC shall occur no later than 15 business days after receipt of a properly documented request for price increase. Any increases accepted by PWC shall become effective the month following approval and be valid for a minimum of one contract year.

P. ESTIMATED QUANTITIES

1. The estimated quantities contained herein in certain items in the Bid are for the purpose of comparing bids, and while they are believed to be close approximations, they are not guaranteed, and settlement will be made on the basis of the work as actually executed at the unit prices in the Bid as accepted. PWC further reserves the right to delete any single

line item or combination of items from the bid and cannot guarantee that all quantities listed in the Contract Documents will be utilized.

2. The Contractor should verify quantities before submitting a bid. Due to conditions that may be found under pavement such as the accurate location of existing water lines, sewer lines, gas lines, and structure services of all types, quantities are subject to change during construction, but this contingency shall not be used for a claim to change unit prices submitted in the Bid.

Q. AWARD OF CONTRACT

1. PWC reserves the right to reject any and all Bids, to waive any and all informalities, and to disregard all nonconforming, nonresponsive, or conditional Bids. PWC reserves the right to request additional information from any or all bidders for evaluation purposes. Failure or refusal to furnish additional information as requested may result in the rejection of the bid.
2. In case of a tie Bid, the tie shall be decided by lot.
3. It is the intent of PWC to recommend the award of this contract to the lowest responsive, responsible Bidder provided the Bid has been submitted in accordance with the requirements of the Bidding Documents and does not exceed the funds available. In determining the lowest responsible Bidder, PWC may consider, among other criteria, the Bidder's past performance conduct on other contracts, and other information provided by the Bidder as noted below.
4. In determining the lowest responsive Bidder, PWC will evaluate the Bidder's proposed Bid price and the completeness of the submitted bid in accordance with the requirements of the Contract Documents.
5. PWC may consider the operating costs, maintenance considerations, performance date, and guarantees of materials and equipment.
6. PWC may conduct such investigations as deemed necessary to assist in the evaluation of any Bid and to establish the responsibility, qualifications and financial ability of the Bidders, as well as other considerations, to include but not limited to resources available to the Bidder to perform the work effectively, proposed Subcontractors and other persons and organizations to do the work in accordance with the Contract Documents to PWC's satisfaction within the prescribed time.
7. PWC reserves the right to reject the Bid of any Bidder who does not pass any such evaluation to PWC's satisfaction.
8. If the Contract is to be awarded, PWC will give the Successful Bidder a Notice of Award within ninety (90) days after the day of the Bid Opening.
9. The Bidder to whom the contract is awarded shall, within ten (10) days after prescribed documents are presented for signature, execute and deliver the Contract Documents and any other forms or bonds required by the Bid to PWC.
10. The Bidder is required to complete the attached forms that will allow PWC to verify that

the Bidder is qualified to perform the Work described in these Contract Documents. All forms shall be completed and submitted with the Bid. Failure to submit all the required forms shall be considered grounds for PWC to reject the bid.

PWC will review all of the bids and qualification data to determine the lowest responsive, responsible Bidder. PWC reserves the right to not award the Contract to the lowest bidder if the information provided is not complete, does not meet the satisfaction of PWC, or has been falsified. PWC will not request any additional information in order to allow the Contractor to complete bid.

11. During the evaluation phase, bid submittals will be reviewed to ascertain which bids technically and otherwise address all the requirements of these Contract Documents. Bid submittals determined to be technically non-responsive or not sufficiently responsive may be disqualified.

The Bidder shall address each of the Evaluation Criteria as requested in the Technical Evaluation Criteria Form located within Section A Project Specifics Bid Submittal Documents. To be considered substantive, the information must respond to all requirements.

12. PWC may conduct such investigations/verifications as deemed necessary to establish the responsibility, qualification and financial ability of the Bidder. Should PWC find that the apparent low bidder is not the lowest responsive, responsible bidder by integrity of the information furnished, said apparent low bidder will be so notified and its bid bond shall be returned without prejudice. Failure or refusal to furnish any items of information requested by PWC shall be considered as non-responsive and therefore basis for rejection of the bid.

R. TAXES

1. The Successful Bidder shall pay all county, city, state and federal taxes required by laws in effect at the time Bids are received and resulting from the Work or traceable thereto, under whatever name levied.
2. Said taxes shall not be in addition to the contract price between PWC and the Successful Bidder. The taxes shall be an obligation of the Successful Bidder and not of PWC. PWC shall be held harmless from same by the Successful Bidder.

S. PERFORMANCE AND OTHER BONDS

1. The PWC General Conditions set forth PWC's requirements as to Performance and other Bonds.

T. E-VERIFY REQUIREMENTS

1. Contractor hereby acknowledges that "E-Verify" is the federal E-Verify program operated by the US Department of Homeland Security and other federal agencies which is used to verify the work authorization of newly hired employees pursuant to federal law and in accordance with Article 2, Chapter 64 of the North Carolina General Statutes.
2. Contractor further acknowledges that all employers, as defined by Article 2, Chapter 64 of the North Carolina General Statutes, must use E-Verify and after hiring an employee to

work in the United States, shall verify the work authorization of the employee through E-Verify in accordance with NCGS §64-26(a).

3. Contractor hereby pledges, attests and warrants through execution of this Agreement that Contractor complies with the requirements of Article 2, Chapter 64 of the North Carolina General Statutes and further pledges, attests and warrants that any subcontractors currently employed by or subsequently hired by Contractor shall comply with any and all E-Verify requirements. Failure to comply with the above requirements shall be considered a breach of this Agreement.

U. IRAN DIVESTMENT ACT

1. As mandated by N.C.G.S. 147-86.59(a), the Contractor hereby certifies that it is not listed on the Final Divestment List created by the North Carolina State Treasurer pursuant to N.C.G.S. 147-86.58. Contractor further certifies that in accordance with N.C.G.S. 146-86.58(b) that it shall not utilize any subcontractor found on the State Treasurer's Final Divestment List. Contractor certifies that the signatory to this Purchase Order authorized by the Contractor to make the foregoing statement.

*** END OF SECTION ***

**SECTION A – PROJECT SPECIFICS
BID SUBMITTAL DOCUMENTS**

**BID SCHEDULE – PERFORMANCE AND DELIVERY
FAYETTEVILLE PUBLIC WORKS COMMISSION
VARIOUS SEWER MANHOLE REHABILITATION (CIP) – FIBERGLASS
REINFORCED EPOXY**

Pre-Bid Meeting:	1:00 p.m., EST Tuesday, August 22, 2023
(MANDATORY)	Fayetteville Public Works Commission Administrative Building Skills Lab 955 Old Wilmington Road Fayetteville, NC 28301
Deadline for Questions from Bidders ¹	5:00 p.m., EST Friday, September 1, 2023
Deadline for Addenda issued by PWC Procurement Department and Engineer ²	5:00 p.m., EST Friday, September 8, 2023
Bid Opening (Submittal Deadline)	1:00 p.m., EST Wednesday, September 13, 2023
	Fayetteville Public Works Commission Administrative Building Conference Room 107 955 Old Wilmington Road Fayetteville, NC 28301
Contract Time:	The Contract shall have an initial term of one (1) year, beginning on the date of Notice to Proceed. At the end of the Contract's initial term, PWC shall have the option, in its sole discretion, to renew the Contract on the same terms and conditions for up to two (2) additional one-year terms
Liquidated Damages:	Not Applicable
Bid Acceptance Period	Within ninety (90) Calendar Days unless otherwise noted

-
1. Questions regarding this bid must be submitted in writing to the attention of Victoria McAllister, Senior Procurement Advisor, by email to victoria.mcallister@faypwc.com.

Bidders are expressly prohibited from contacting any FPWC official or employee associated with this Invitation to Bid, except as noted above. Violation of this prohibition is grounds for the immediate disqualification of the bidder.

2. Any addenda to these Contract Documents will be issued by the Engineer no later than the date and time stated above.

BID SUBMITTAL CHECKLIST

- 1. Enter Contractor's License Number where called for in the Bid Form and on the outside of the sealed envelope containing the Bid.
- 2. Photocopy of Contractor's License.
- 3. Bid Bond
- 4. Bid Forms Section 00300
- 5. Provide the responsible North Carolina Registered Agent for Insurance Claims. Include contact information.
- 6. Provide the proposed responsible Bonding Company name. Include contact information.
- 7. List of proposed Subcontractors and material suppliers exceeding 5% of the Contract Value.
- 8. Non-Collusive Affidavit.
- 9. Nondiscrimination Clause.
- 10. Affidavit of Organization and Authority and Sworn Statement.
- 11. Equal Employment Opportunity Acknowledgment.
- 12. Certification regarding Debarment, Proposed Debarment, and other Responsible Matters.
- 13. FTA Certification Regarding Lobbying.
- 14. Identification of Minority Business Participation Form.
- 15. Affidavit A – Listing of Good Faith Efforts, et al.
- 16. Affidavit B – (Only if the Contractor will perform **ALL ELEMENTS OF THE WORK** on this project with their own forces **AND** will complete **ALL ELEMENTS OF THIS PROJECT WITHOUT THE USE OF SUBCONTRACTORS, MATERIAL SUPPLIERS, OR PROVIDERS OF PROFESSIONAL SERVICES.**
- 17. MWDBE Program Forms
- 18. SLS Disclosure Form.
- 19. The Completed Contractor Qualification Form.

FAILURE TO SUBMIT THE ABOVE FORMS WITH THE BID FORM MAY BE JUST CAUSE FOR REJECTION OF THE BID BY THE OWNER

***** THIS PAGE INTENTIONALLY LEFT BLANK *****

00300 - BID FORM

TO: **Fayetteville Public Works Commission**
Attn: Victoria McAllister, Procurement Advisor
955 Old Wilmington Road
Fayetteville, North Carolina 28301

PROJECT: **VARIOUS SEWER MANHOLE REHABILITATION (CIP) – FIBERGLASS REINFORCED EPOXY**

FROM: BIDDER _____
ADDRESS _____

DATE OF BID _____, 20 _____

- A. The undersigned BIDDER proposes and agrees, if this Bid is accepted, to enter into a Contract with OWNER in the form included in the Contract Documents to perform and furnish all Work (as that term is defined in the Construction Agreement) specified or indicated in the Contract Documents for the Contract Price and within the Contract Time indicated in this Bid and in accordance with the Contract Documents.
- B. BIDDER accepts all of the terms and conditions of the Instructions to Bidders, including, without limitation, those dealing with the disposition of payment and performance bonds, and insurance certificates. This bid will remain open for ninety (90) calendar days after the day of Bid opening. BIDDER will sign the Contract and submit the Contract Security and other documents required by the Contract Documents within ten (10) days after the date of receipt by the BIDDER.
- C. In submitting this Bid, Bidder represents, as more fully set forth in the Contract, that:
 - 1. BIDDER has examined copies of all the Contract Documents and of the following addenda, receipt of all which is acknowledged on the bid summary page:
 - 2. BIDDER has examined the site and locality where the Work is to be performed, the legal requirements (federal, state, and local laws, ordinances, rules and regulations) and the conditions affecting cost, progress of performance of the work and has made such independent investigations as BIDDER deems necessary.
 - 3. BIDDER acknowledges that OWNER does not assume responsibility for the accuracy of dimensions or completeness of information and data shown or indicated in the Bidding Documents with respect to existing facilities.
 - 4. BIDDER has carefully studied all reports of explorations and tests of subsurface conditions at or contiguous to the site of the Work (except underground facilities)

and all drawings of physical conditions in or relating to existing surface or subsurface structures, pipelines, and utilities at or contiguous to the site are provided within these Contract Documents. Geotechnical Reports and other information regarding subsurface conditions are identified in the attached appendices and detailed in Article V of the PWC General Conditions. BIDDER acknowledges that the OWNER does not assume responsibility for the accuracy or completeness of information and data shown or indicated in the Bidding Documents with respect to underground facilities at or contiguous to the site of Work. BIDDER had obtained and carefully studied (or assumes responsibility for have done so) all such additional or supplementary examinations investigations, explorations, tests, studies, and data that are necessary to identify and understand conditions (surface, subsurface, and underground facilities) at or contiguous to the site of Work or otherwise which may affect cost, progress, performance, or furnishing the Work or which relate to any aspect of means, methods, techniques, sequences, and procedures of construction to be employed by Bidder and safety precautions and programs incident thereto. BIDDER waives all rights to claim that any additional examinations, investigations, explorations, tests, studies, or data are necessary for the proper submission of the Bid for the performance and furnishing of the Work in accordance with the Contract Time, Contract Price, and other terms and conditions of the Contract Documents.

5. BIDDER hereby certifies that, if awarded the Contract for construction of the Project, it will take all possible actions to minimize costs to the OWNER which are related to any disruptions in any part of the Work resulting from unforeseeable conditions which may be encountered and work changes or additions which may be made.
6. BIDDER has correlated the information known to BIDDER, information and observations obtained from visits to the site, reports and drawings identified in the Contract Documents, and all additional examinations, investigations, exploration, tests, studies, and data with the Contract Documents.
7. BIDDER has given OWNER written notice of all conflicts, errors, ambiguities, or discrepancies that BIDDER has discovered in the Contract Documents and the written resolution thereof by OWNER is acceptable to BIDDER, and the Contract Documents are generally sufficient to indicate and convey understanding of all terms and conditions for performing and furnishing the Work for which this Bid is submitted.
8. By bidding in response to this invitation, the BIDDER represents that in the preparation and submission of this Bid, said BIDDER did not, either directly or indirectly, enter into any combination or arrangement with any person, firm or corporation or enter into any agreement, participate in any collusion, or otherwise take any action in the restraint of free, competitive bidding in violation of the Sherman Act (15 U.S.C. Section 1).
9. Bid form must be completed in blue or black ink or by typewriter. The Bid price of

each item on the form must be stated in both words and numerals. In case of a conflict, words shall take precedence. Discrepancies in the multiplication of units of work and unit prices will be resolved in favor of the correct multiplication of the unit prices. Discrepancies between the indicated sum of any column of figures and the correct sum thereof will be resolved in favor of the correct sum.

10. BIDDER understands that the award of contract will be made on the basis of the total Bid amount which will be determined as the sum of the unit price and lump sum Bid Items.
11. BIDDER understands that quantities are estimated and are not guaranteed; they are solely for comparing Bids and establishing the total Bid amount. The Price will be modified by Change Order, and final payment will be based on the quantities of work actually furnished and installed by the successful BIDDER.
12. BIDDER shall complete the Work for the prices indicated on the next page.

00300 – BID PRICING FORM

BIDDER NAME _____

1. Item No.	Ref. No.	Item	Estimated Quantities	Unit	Unit Price	Cost Extension
1	L-1	Mobilization	1	L.S.	\$20,000.00	\$20,000.00
2	U-1	Bench and Invert Replacement	20	EA		
3	U-2	Cover and Frame Resetting	10	EA		
4	U-3	Install Locking Ring & Cover	35	EA		
5	U-4	Chimney Seals	400	EA		
6	U-5	Rehabilitate Manholes Utilizing a CIP – Fiberglass Reinforced Epoxy Lining Measured by Vertical Feet (4' Diameter Manhole)	500	V.F.		
7	U-6	Rehabilitate Manholes Utilizing a CIP – Fiberglass Reinforced Epoxy Lining Measured by Square Feet (Greater than 4' Dia. Manhole)	7000	S.F.		
8	U-7	Abrasive Blast Cleaning	20	EA		
9	U-8	Remove and Replace Inside Drop Structure	5	EA		

TOTAL BASE BID

\$ _____

The undersigned BIDDER hereby agrees to accept an award of the Contract based on the Total Contract Amount as accepted by the OWNER and as indicated on the Notice of Award.

A. BIDDER agrees that Work shall be completed within the time frame indicated in the Agreement as follow:

1. All work described herein to be complete, including restoration and all punch list items from Notice to Proceed until June 30, 2023.
2. The BIDDER acknowledges that time is of the essence in this Contract and that the OWNER will suffer financial loss if the Work is not complete within the time specified in Paragraph D.1 above plus any extensions thereof allowed in accordance with these Contract Documents. BIDDER also recognizes the delays, expense and difficulties involved in proving in a legal proceeding the actual loss suffered by the OWNER if the Work is not complete on time. The Bidder agrees to diligently pursue all available work and complete all work in an expeditious manner.

B. The following documents are attached to and made part of this bid:

Required Bid Security in the form of either a cashier's check or certified check or Bid Bond in the amount of 5% of maximum Bid price.

C. Communications concerning this Bid shall be addressed to: (CONTRACTOR's Name, Address and Telephone Number)

D. The terms used in this Bid which are defined in Definitions and Terminology Section of the PWC General Conditions or as otherwise specifically defined in the Contract Documents have the meanings assigned to them therein, which are incorporated by reference as if fully set forth herein.

E. An individual contractor is required to furnish his social security number and sole proprietorship, partnership and corporation are required to furnish their employer identification numbers to Fayetteville Public Works Commission. Please indicate this information on this Bid Form as follows:

Social Security Number: _____

Federal Employer Identification Number: _____

SUBMITTED ON ____ day of _____ 2023

AN INDIVIDUAL

BY: _____ (SEAL)

(Individual's Name and Signature)

Doing Business as: _____

North Carolina Contractor Registration Number: _____

Business Address: _____

Phone Number: _____

Subscribed and sworn to before me this ____ day of _____ 2023

NOTARY PUBLIC

My Commission Expires: _____

A PARTNERSHIP

BY: _____ (SEAL)

(Firm Name)

(General Partner and Signature)

North Carolina Contractor Registration Number: _____

Business Address: _____

Phone Number: _____

Subscribed and sworn to before me this ____ day of _____ 2023

NOTARY PUBLIC

My Commission Expires: _____

A CORPORATION

BY: _____
(Corporation Name) (State of Incorporation)

BY: _____ (SEAL)
(Name and Title of Person Authorized to Sign and Signature)

ATTEST: _____
(Secretary or Assistant Secretary and Signature)

North Carolina Contractor Registration Number: _____

Business Address: _____

Phone Number: _____

Subscribed and sworn to before me this ____ day of _____ 2023

NOTARY PUBLIC
My Commission Expires: _____

A JOINT VENTURE

BY: _____
(Name and Signature)

Doing Business as: _____

North Carolina Contractor Registration Number: _____

Business Address: _____

Phone Number: _____

Subscribed and sworn to before me this ____ day of _____ 2023

NOTARY PUBLIC
My Commission Expires: _____

(Each joint venturer must sign. The name of signing for each individual, partnership, and corporation that is a party to the joint venture should be in the manner indicated above.)

CONTRACTOR QUALIFICATION FORM

SEWER MANHOLE REHABILITATION (CIP) – FIBERGLASS REINFORCED EPOXY CONTRACTOR QUALIFICATION FORM

*****MUST BE COMPLETED AND INCLUDED WITH BID*****

Fayetteville Public Works Commission reserves the right to request information from the contractor to complete its assessment of the contractor or subcontractors qualifications. Partially complete forms may be considered non-responsive based on the quantity and quality of information provided. Wholly incomplete forms will be considered non-responsive and will result in rejection of the bid.

CONTRACTOR DOCUMENTATION

(1) Name of Prime Contractor and NC License Number :	Name: NC License No.:
a. Within the last five (5) years , has the contractor been involved in any judgments, claims, or arbitration with regard to construction contracts? If so, provide list and describe each event fully. Attach additional information, as necessary.	<input type="checkbox"/> Yes (provide list and describe each event fully) <input type="checkbox"/> No
b. Within the last five (5) years , has any officer or principal of the organization ever been an officer or principal of another organization when it failed to complete a construction contract? If so, provide list and describe each event fully. Attach additional information, as necessary.	<input type="checkbox"/> Yes (provide list and describe each event fully) <input type="checkbox"/> No
c. Provide documentation (to be submitted with the Bid) that the Contractor and Lining Material Manufacturer (both cement and polymeric materials) have been in business a minimum of 10 years under the same business entity name.	
(2) Provide list of Subcontractors and field of specialty (erosion control, access, etc.), if applicable. Additional subcontractors can be attached to the qualifications form, if necessary.	
a. Subcontractor Name: Specialty:	
b. Subcontractor Name: Specialty:	
c. Subcontractor Name: Specialty:	
d. Subcontractor Name: Specialty:	

**PRIME CONTRACTOR SEWER MANHOLE REHABILITATION
EXPERIENCE AND RESOURCES**

- (1) The Contractor shall have a minimum of **six (6)** years active experience in commercial installation of the product. The Contractor shall provide not less than **four (4)** references documenting a minimum of 800 manholes (combined between references), with a minimum of **four (4)** years of service in the ground, of successful installation of the proposed lining system within the United States. The Contractor shall have completed a minimum of **four (4)** separate lining projects within the previous **five (5)** years. These projects shall be of similar scope and nature to the Work described in these Contract Documents. A minimum of **one (1)** project shall include a minimum of 300 manholes completed within **one (1)** calendar year (or a period less than 365 days), this project shall have been completed in the Southeast United States (SC, NC, VA). The Contractor shall have completed a minimum of **three (3)** years of continuous experience on similar spray applications and/or trowel type underlayment projects.
- (2) Include the dates of such projects. The client's representative, name, and telephone numbers shall be provided for reference of each project listed. Contractor shall provide references for Fayetteville Public Works Commission to verify project information. Each project should be from separate references. Additional similar projects may be attached at the Contractor's discretion.

a. Project Name:			
Location:			
Superintendent:			
Cost:			
Types of Structures:		# Of Structures	
Start Date:		End Date:	
Client:			
Client Contact Name:		Client Phone:	
Scope/Additional Information:			
b. Project Name:			
Location:			
Superintendent:			
Cost:			
Types of Structures:		# Of Structures	
Start Date:		End Date:	
Client:			
Client Contact Name:		Client Phone:	
Scope/Additional Information:			
c. Project Name:			
Location:			
Superintendent:			
Cost:			
Types of Structures:		# Of Structures	
Start Date:		End Date:	
Client:			

Client Contact Name:		Client Phone:	
Scope/Additional Information:			
d. Project Name:			
Location:			
Superintendent:			
Cost:			
Types of Structures:		# Of Structures	
Start Date:		End Date:	
Client:			
Client Contact Name:		Client Phone:	
Scope/Additional Information:			
e. Project Name:			
Location:			
Superintendent:			
Cost:			
Types of Structures:		# Of Structures	
Start Date:		End Date:	
Client:			
Client Contact Name:		Client Phone:	
Scope/Additional Information:			
(3) Provide the number of crews qualified and available to perform the work stated in this Proposal:			
(4) Provide the name of the proposed superintendent (list only one (1)) and proposed crew leaders who are qualified and available to perform the work stated in this proposal:	Proposed Superintendent (list only one (1)):		
	Crew leaders/foreman:		
(5) The Contractor's superintendent (named above) shall have been responsible for or managed projects similar in size to this proposed project, in the past four (4) years in the United States. Contractor shall provide a minimum of five (5) references, to document the proposed superintendent's ability and qualifications to meet this requirement. Each reference should be from separate projects. A minimum of one (1) project shall include a minimum of 200 manholes completed within one (1) calendar year (or a period less than 365 days) and completed in the southeast United States (NC, SC, VA). Additional similar projects may be attached at the Contractor's discretion.			
<u>**The number of structures in the following Superintendent's References DO NOT COUNT towards the Prime Contractors total numbers above.**</u>			

a. Project Name:			
Location:			
Types of Structures:		# Of Structures	
Start Date:		End Date:	
Client:			
Client Contact Name:		Client Phone:	
Scope/Additional Information:			
b. Project Name:			
Location:			
Types of Structures:		# Of Structures	
Start Date:		End Date:	
Client:			
Client Contact Name:		Client Phone:	
Scope/Additional Information:			
c. Project Name:			
Location:			
Types of Structures:		# Of Structures	
Start Date:		End Date:	
Client:			
Client Contact Name:		Client Phone:	
Scope/Additional Information:			

d. Project Name:			
Location:			
Types of Structures:		# Of Structures	
Start Date:		End Date:	
Client:			
Client Contact Name:		Client Phone:	
Scope/Additional Information:			

e. Project Name:			
Location:			
Types of Structures:		# Of Structures	
Start Date:		End Date:	
Client:			
Client Contact Name:		Client Phone:	
Scope/Additional Information:			
(6) Provide a list of applicable equipment(including make/model/size/quantity) owned by the prime contractor that will be utilized to complete the scope of work:			
a. Lining equipment:			
b. Cleaning equipment:			
c. Other Lining Support Equipment:			
(1) The Contractor shall be certified and/or licensed as an installer by the manufacturer of the proposed lining system. The Contractor shall submit a certified statement from the manufacturer that they are a certified and/or licensed installer of the lining material.			
(2) All manufacturers of proposed lining system shall be certified for the proposed lining system for the design, production, installation, and service of the lining system for a sanitary sewer collection system, and shall submit proof of certification.			
(3) The Contractor certifies that they will have a minimum of two (2) crews available to complete the work that may be assigned during each contract period.			

Fayetteville Public Works Commission may conduct such investigations/verifications as deemed necessary to establish the responsibility, qualification and financial ability of the Bidder. Should Fayetteville Public Works Commission adjudge that the apparent low bidder is not the lowest responsive, responsible bidder by virtue of the above information furnished, said apparent low bidder will be so notified and his bid security shall be returned to him without prejudice. Failure or refusal to furnish any items of information requested by Fayetteville Public Works Commission shall be considered as non-responsive and therefore basis for rejection of the bid.

Submitted By (print):	Date:
Title:	
Company:	
Signature:	

LIST OF SUBCONTRACTORS

In compliance with the Instructions to Bidders and the Supplementary Conditions, the undersigned submits the following names of Subcontractors to be used in performing the Work.

The Bidder certifies that all Subcontractors listed are eligible to perform the Work and that all Subcontractors performing more than five percent of the work are listed.

<u>Subcontractor's Work</u>	<u>Subcontractor's Name</u>
_____	_____
_____	_____
_____	_____
_____	_____
_____	_____

Bidder's Signature

BID BOND

This is a Bid Bond that is subject to the provisions of Article 3 of Chapter 44A of the North Carolina General statutes.

This Bond is executed on _____, 20 ____ .

The name of the PRINCIPAL is _____ (1)

_____ (2)

The name of the SURETY is _____

Fayetteville Public Works Commission, Fayetteville, North Carolina is the OWNER

The amount of the Bond is _____

_____ (Dollars) (\$ _____)

KNOW BY ALL MEN BY THESE PRESENTS, the Principal and Surety above named are hereby held and firmly bound unto the above named OWNER hereinafter called the OWNER in the penal sum of the amount stated above in lawful money of the United States, for the payment of which, well and truly to be made, we hereby jointly and severally bind ourselves, our heirs, executors, administrators, successors and assigns.

The condition of the above obligation is such that whereas the Principal has submitted to the OWNER a certain Bid, attached hereto and hereby made a part hereof to enter into a Contract in writing, for the construction of:

VARIOUS SEWER MANHOLE REHABILITATION (CIP) – FIBERGLASS REINFORCED EPOXY

NOW, THEREFORE

- (a) If said Bid shall be rejected, or in the alternate,
- (b) If said Bid shall be accepted and the Principal shall execute and deliver a Contract in the Form of Contract attached hereto (properly completed in accordance with said Bid) and shall furnish a bond for his faithful performance of said Contract, and for the payment of all persons performing labor or furnishing materials in connection therewith, and shall in all other respects perform the agreement created by the acceptance of said Bid, then this obligation shall be void, otherwise the same shall remain in force and effect; it being expressly understood and agreed that the liability of the Surety for any and all claims hereunder shall, in no event, exceed the penal amount of this obligation as herein stated.

VARIOUS SEWER MANHOLE REHABILITATION (CIP) – FIBERGLASS REINFORCED EPOXY

The Surety, for value received, hereby stipulates and agrees that the obligations of said Surety and its Bond shall be in no way impaired or affected by any extension of the time within which the Owner may accept such Bid; and said Surety does hereby waive notice of any such extension.

IN WITNESS WHEREOF, the Principal and the Surety have hereunto set their hands and seals, and such of them as are corporations have caused their corporate seals to be hereto affixed and these presents to be signed by their proper officers, the day and year first set forth above.

ATTEST:

(Principal Secretary)
(SEAL)

Principal

BY: _____ (3)

(Address)

Witness as to Principal

Surety

(Address)

(Address)

ATTEST:

N.C. Resident Agent
(SEAL)

Witness as to Surety

(Address)

- (1) Correct name of Contractor
- (2) A Corporation, a Partnership or an Individual, as the case may be
- (3) If Contractor is a Partnership, all partners should execute Bond

**POWER OF ATTORNEY
(Attach)**

**AFFIDAVIT OF ORGANIZATION AND AUTHORITY SWORN STATEMENT
VARIOUS SEWER MANHOLE REHABILITATION (CIP) – FIBERGLASS REINFORCED
EPOXY**

STATE OF _____

COUNTY OF _____

_____ being the first duly sworn on oath deposes and says that the Bidder on the attached Bid Form is organized as indicated below and that all statements herein made are made on behalf of such Bidder and that this deponent is authorized to make them.

(Fill Out Applicable Paragraph)

1. CORPORATION

The bidder is a corporation organized and existing under the laws of the State of _____ and its President is _____, and its Secretary is _____, and does have a corporate seal. The _____ is authorized to sign construction Contract and Bids for the company by action of its Board of Directors taken _____, a certified copy of which is hereto attached. (Strike out last sentence if not applicable.)

2. PARTNERSHIP

The Bidder is a Partnership consisting of _____ and _____, partners doing business under the name of _____.

3. SOLE TRADER

The Bidder is an individual and if operating under a trade name, such trade name is as follows:

4. ADDRESS

The business address of the Bidder is as follows:

Its phone number is _____

Bidder

By: _____

EQUAL EMPLOYMENT OPPORTUNITY

During the performance of this Contract the Contractor agrees as follows:

- a. The Contractor will not discriminate against any employee or applicant because of race, color, religion, sex, or national origin. The Contractor will take affirmative action to ensure that applicants are employed, and that employees are treated during employment, without regard to race, color, religion, sex, or national origin. Such action shall include but not be limited to the following: employment, upgrading, demotion, or transfer, recruitment or recruitment advertising, layoff or termination, rates of pay or other forms of compensation, and selection for training, including apprenticeship. The Contractor agrees to post in conspicuous places, available to employees and applicants for employment, notices setting forth the provisions of the nondiscrimination clause.
- b. The Contractor will, in all solicitations or advertisements for employees placed by or on behalf of the Contractor, state that all qualified applicants will receive consideration for employment without regard to race, color, religion, sex, or national origin.
- c. The Contractor will send to each labor union or representative of workers with which he has a collective bargaining agreement or other Contract understanding, a notice, to be provided, advising the labor union or worker's representative of the Contractor's commitments under the Equal Employment Opportunity Section of this Contract, and shall post copies of the notice in conspicuous places available to employees and applicants for employment.
- d. In the event of the Contractor's noncompliance with the nondiscrimination clauses of this Contract or with any of such rules, regulations, or orders, this Contract may be canceled, terminated, or suspended in whole or in part and the Contractor may be declared ineligible for further OWNER Contracts.
- e. The Contractor will include the provisions of this section in every subcontract or purchase order unless exempted by rules, regulations, or orders of the OWNER so that such provisions will be binding upon each Subcontractor or vendor.

(Use the following form for signatures by a CORPORATION):

Corporate Name

ATTEST:

(Assistant) Secretary

(Vice) President

(CORPORATE SEAL)

(Use the following form for signatures by and INDIVIDUAL):

BY: _____ (Seal)

WITNESS:

(ACKNOWLEDGEMENT OF THE ABOVE SIGNATURE MUST BE NOTARIZED USING FORM ON FOLLOWING PAGE)

NONDISCRIMINATION CLAUSE

It is specifically agreed as part of the consideration of the signing of this Contract that the parties hereto, their agents, officials, employees or servants will not discriminate in any manner on the basis of age, handicap, race, color, creed, sexual orientation or national origin with reference to the subject matter of this Contract, no matter how remote.

This provision being incorporated for the benefit of Fayetteville Public Works Commission, Fayetteville, North Carolina and its residents may be enforced as set out in said ordinances, enforcement of this provision shall be by action for specific performance, injunctive relief, or other remedy as by law provided.

This provision shall be binding on the successors and assigns of the parties hereto with reference to the subject matter of this Contract.

(Use the following form for signatures by a CORPORATION):

Corporate Name

ATTEST:

(Assistant) Secretary

BY: _____
(Vice) President

(Printed Name)

BY: _____
(Printed Name)

(Corporate Seal)

(Use the following form for signatures by a PARTNERSHIP or INDIVIDUAL):

BY: _____(SEAL)

(Printed Name)

WITNESS:

(Printed Name)

NON-COLLUSIVE AFFIDAVIT

State of _____)
_____)

County of _____)

_____ being first duly sworn,
deposes and says that:

- (1) He is the _____
(Owner, Partner, Officer, Representative or Agent)
of _____ the BIDDER that has
submitted the attached BID;
- (2) He is fully informed respecting the preparation and contents of the attached BID and of all
pertinent circumstances respecting such BID;
- (3) Such BID is genuine and is not a collusive or sham BID;
- (4) Neither the said BIDDER nor any of its officers, partners, owners, agents, representatives,
employees or parties in interest, including this affiant, have in any way colluded, conspired,
connived or agreed, directly or indirectly, with any other BIDDER, firm, or person to submit
a collusive or sham BID in connection with the Contract for which the attached BID has
been submitted; or to refrain from bidding in connection with such Contract; or have in any
manner, directly or indirectly, sought by agreement or collusion, or communication, or
conference with any BIDDER, firm, or person to fix the price or prices in the attached BID
or of any other BIDDER, or to fix any overhead, profit, or cost elements of the BID price
or the BID price of any other BIDDER, or to secure through any collusion, conspiracy,
connivance, or unlawful agreement any advantage against (Recipient), or any person
interested in the proposed Contract;
- (5) The price or prices quoted in the attached BID are fair and proper and are not tainted by
any collusion, conspiracy, connivance, or unlawful agreement on the part of the BIDDER
or any other of its agents, representatives, owners, employees or parties in interest,
including this affidavit.

BY _____

ITS _____
(Title)

Subscribed and sworn to before me this _____ day of _____, 20 ____ .

Notary Public

My Commission Expires:

END OF AFFIDAVIT

F.T.A. CERTIFICATION REGARDING LOBBYING

Certification for Contracts, Grants, Loans, and Cooperative Agreements

(To be submitted with each bid or offer exceeding \$100,000)

The undersigned _____ certifies, to the best of his or her knowledge and belief, that:

- (1) No federal appropriated funds have been paid or will be paid, by or on behalf of the undersigned, to any person for influencing or attempting to influence an officer or employee of an agency, a member of Congress, an officer or employee of Congress, or an employee of a member of Congress in connection with the awarding of any federal contract, the making of any federal grant, the making of any federal loan, the entering into of any cooperative agreement, and the extension, continuation, renewal, amendment, or modification of any federal contract, grant, loan, or cooperative agreement.
- (2) If any funds other than federal appropriated funds have been paid or will be paid to any person for making lobbying contacts to an officer or employee of any agency, a member of Congress, an officer or employee of Congress, or an employee of a member of Congress in connection with this federal contract, grant, loan, or cooperative agreement, the undersigned shall complete and submit Standard Form--LLL, "Disclosure Form to Report Lobbying," in accordance with its instructions [as amended by "Government wide Guidance for New Restrictions on Lobbying," 61 Fed. Reg. 1413 (1/19/96). Note: Language in paragraph (2) herein has been modified in accordance with Section 10 of the Lobbying Disclosure Act of 1995 (P.L. 104-65, to be codified at 2 U.S.C. 1601, *et seq.* .)]
- (3) The undersigned shall require that the language of this certification be included in the award documents for all subawards at all tiers (including subcontracts, subgrants, and contracts under grants, loans, and cooperative agreements) and that all subrecipients shall certify and disclose accordingly.

This certification is a material representation of fact upon which reliance was placed when this transaction was made or entered into. Submission of this certification is a prerequisite for making or entering into this transaction imposed by 31, U.S.C. § 1352 (as amended by the Lobbying Disclosure Act of 1995). Any person who fails to file the required certification shall be subject to a civil penalty of not less than \$10,000 and not more than \$100,000 for each such failure.

[Note: Pursuant to 31 U.S.C. § 1352(c)(1)-(2)(A), any person who makes a prohibited expenditure or fails to file or amend a required certification or disclosure form shall be subject to a civil penalty of not less than \$10,000 and not more than \$100,000 for each such expenditure or failure.]

The Contractor, _____, certifies or affirms the truthfulness and accuracy of each statement of its certification and disclosure, if any. In addition, the Contractor understands and agrees that the provisions of 31 U.S.C. A 3801, *et seq.*, *apply* to this certification and disclosure, if any.

_____ Signature of Contractor's Authorized Official

_____ Name and Title of Contractor's Authorized Official

_____ Date

**CERTIFICATION OF PRIMARY PARTICIPANT REGARDING DEBARMENT,
SUSPENSION AND OTHER RESPONSIBILITY MATTERS**

The Primary Participant, _____ (major third party contractor), certifies to the best of its knowledge and belief, that it and its principals:

1. Are not presently debarred, suspended, proposed for debarment, declared ineligible, or voluntarily excluded from covered transactions by any Federal department or agency;
2. Have not within a three-year period preceding this proposal been convicted of or had a civil judgment rendered against them for commission of fraud or a criminal offense in connection with obtaining, attempting to obtain, or performing a public (Federal, State or local) transaction or contract under a public transaction; violation of Federal or State antitrust statutes or commission of embezzlement, theft, forgery, bribery, falsification or destruction of records, making false statements, or receiving stolen property;
3. Are not presently indicted for or otherwise criminally or civilly charged by a governmental entity (Federal, State or local) with commission of any of the offenses enumerated in paragraph (2) of this certification; and
4. Have not within a three-year period preceding this application/proposal had one or more public transactions (Federal, State or local) terminated for cause or default.

(If the primary participant is unable to certify to any of the statements in this certification, the participant shall attach an explanation to this certification.)

THE PRIMARY PARTICIPANT _____ CERTIFIES OR AFFIRMS THE TRUTHFULNESS AND ACCURACY OF THE CONTENTS OF THE STATEMENTS SUBMITTED ON OR WITH THIS CERTIFICATION AND UNDERSTANDS THAT THE PROVISIONS OF 31 U.S.C. SECTIONS 3801 ET. SEQ. ARE APPLICABLE THERETO.

Signature

Title

Printed Name

Date



**MINORITY, WOMEN, AND DISADVANTAGED
BUSINESS ENTERPRISE PROGRAM**

for

**Construction, A&E Services, Purchase Contracts,
Professional Services, and General Services**

Contents

PURPOSE	4
OVERVIEW	4
I. INTRODUCTION	5
II. ADMINISTRATION	5
III. DEFINITIONS	5
IV. PROCEDURES FOR CONSTRUCTION CONTRACTS	7
A. Purpose and Application	7
B. MWDBE Aspirational Goals	7
C. Invitation for Bids	7
D. PWC Responsibilities	8
E. Contractor Good-Faith Efforts	9
F. Awarding of Construction Contracts	11
G. Counting MWDBE Participation Toward Meeting the Aspirational Goals	12
H. Documentation of Attainment of MWDBE Participation Requirements	13
V. PROCEDURES FOR ARCHITECTURE & ENGINEERING (A&E) CONTRACTS	13
A. Purpose and Application	13
B. MWDBE Aspirational Goals	14
C. Request for Qualifications	14
D. PWC Responsibilities	14
E. Meeting MWDBE Aspirational Goals	15
F. Counting MWDBE Participation	15
G. Provider Good-Faith Efforts	15
H. Documenting Good-Faith Efforts	16
VI. PROCEDURES FOR PURCHASE CONTRACTS	17
A. Purpose and Application	17
B. MWDBE Aspirational Goals	17
C. Request for Quotes or Invitation for Bids	17
D. PWC Responsibilities	18
E. Award of Purchase Contracts	19
VII. PROCEDURES FOR PROFESSIONAL, GENERAL (OTHER) SERVICE CONTRACTS	19
A. Purpose and Application	20
B. MWDBE Aspirational Goals	20
C. PWC's Responsibilities	20
D. Request for Proposals	21
E. Meeting MWDBE Aspirational Goals	21
F. Counting MWDBE Participation	21

G. Provider Good-Faith Efforts	22
I. Documenting Good-Faith Efforts	23
VIII. UTILIZATION OF JOINT VENTURE	23
IX. MWDBE REPORTING PROCEDURE	24
MWDBE COMPLIANCE PROVISIONS	25
Affidavit A: Listing of the Good Faith Efforts	27
Affidavit B: Intent to Perform Contract with Own Workforce	28
Affidavit C: Percentage of MWDBE Participation	29
Affidavit D: Good Faith Efforts	31
Affidavit E: Identification of MWDBE/Local Participation	32
MWDBE ADD / CHANGE FORM	33

PURPOSE

The Fayetteville Public Works Commission (PWC) is committed to promoting the utilization of Minorities, Women, and Disadvantaged Businesses by providing equal opportunity for participating in all aspects of PWC's contracting and procurement programs, including but not limited to, construction projects, A&E services, purchase contracts, and professional and general (other) service contracts.

To achieve this purpose, PWC has established this Minority, Women, and Disadvantaged Business Enterprise Program (MWDBE) to support historically underutilized businesses, encourage capacity development, and offer procurement opportunities to certified business enterprises.

OVERVIEW

PWC's MWDBE Program is a voluntary goals program in construction, A&E services, purchase contracts, and professional and general (other) services based on "good-faith efforts." These goals are established for a five-year period and achievement will be evaluated annually.

The aspirational goals of PWC for the utilization of Minority, Women, and Disadvantaged Business Enterprises are:

Minority business participation in construction services	14%
Women business participation in construction services	11%
Minority business participation in A&E services	6%
Women business participation in A&E services	5%
Minority business participation in purchase contracts	4%
Women business participation in purchase contracts	4%
Minority business participation in professional services	19%
Women business participation in professional services	3%
Minority business participation in general (other) services	9%
Women business participation in general (other) services	4%

I. INTRODUCTION

In 2021, Fayetteville Public Works Commission (PWC) contracted with Griffin & Strong, P.C. (GSPC) to conduct a Disparity Study to determine the effectiveness of the current policies related to local, minority, and women owned businesses and to recommend modifications and adjustments, if necessary, to PWC's policies that comply with the law.

PWC continues to implement race and gender conscious and race and gender-neutral measures to try to increase utilization of Minority, Women, and Disadvantaged Business Enterprise (MWDBE) firms. PWC has a basis to continue race and gender conscious remedies or policies toward achieving annual aspirational goals.

The MWDBE aspirational goals and guidelines developed and recommended do not require nor provide for racially based set-asides; rather they require good-faith effort by both local government and contractors to recruit and select minorities and women businesses, consistent with North Carolina Statutes and the Constitution of the United States as interpreted by the Croson Decision.

II. ADMINISTRATION

PWC General Manager/CEO is authorized to take all usual and legal administrative actions necessary to implement this Program. The ultimate responsibility for the MWDBE Program administration is assigned to the PWC General Manager/CEO or its designee. PWC General Manager/CEO or its designee is either to be personally responsible or to designate a specific person to coordinate and manage this Program. PWC General Manager/CEO or its designee is responsible for determining whether a contractor has complied with this Program and shown good-faith efforts to do so. Except for those staff services specifically assigned by this Program to other departments, the heads of departments responsible for the construction, and procurement of services and goods shall be responsible to PWC General Manager/CEO or its designee and shall cooperate with PWC General Manager/CEO or its designee in implementing this Program.

The MWDBE Program shall apply to all construction contracts, A&E contracts, purchase contracts, and services as specified in Sections IV through VII. The provisions of this Program take precedence over any other department plans or procedures in conflict herewith, except specific requirements mandated by terms or conditions of agreements in force between PWC and the federal government or the State of North Carolina that require different procedures than those described in this Program. This Program will be evaluated at the end of five years to determine its effectiveness and what adjustments are required.

III. DEFINITIONS

Affirmative Action - Specific steps to eliminate discrimination and efforts to ensure nondiscriminatory results and practices in the future, and to fully involve Minority, Women, and Disadvantaged Business Enterprises in contracts and programs.

Aspirational Goal/Goal - A voluntary percentage or quantitative objective.

Bidder/Participant - Any person, firm, partnership, corporation, association, or joint venture seeking to be awarded a public contract or subcontract.

Contract - A mutually binding legal relationship or any modification thereof obligating the seller to furnish equipment or service, including construction and leases, and obligating the buyer to pay for them.

Contractor - Any person, firm, partnership, corporation, association, or joint venture that has been awarded a public contract or lease, including every subcontract on such a contract.

Day – A calendar day of 24 hours measured from midnight to the next midnight. Also referred to throughout the Program documents as “days or “calendar days.”

Discrimination - To distinguish, differentiate, separate and/or segregate on the basis of age, race, religion, color, sex, national origin, handicap and/or veteran status.

Equipment - Includes materials, supplies, commodities, and apparatus.

Joint Venture - An association of two or more businesses to carry out a single business enterprise for profit, for which purpose they combine their property, capital, efforts, skills, and knowledge.

Lessee - A business that leases, or is negotiating to lease, property from PWC or equipment or services to PWC, or to the public on PWC property.

Minority - A person who is a citizen or lawful permanent resident of the United States and who is:

- a. Black American (a person having origins in any of the black racial groups of Africa);
- b. Hispanic American (a person of Mexican, Puerto Rican, Cuban, Central or South American, or other Spanish culture or origin, regardless of race);
- c. Portuguese (a person of Portuguese, Brazilian, or other Portuguese culture origin, regardless of race);
- d. Asian American (a person having origins in any of the original people of the Far East, Southeast Asia, the Indian sub-continent, or the Pacific Islands); and
- e. Native American (a person having origins in any of the original people of North America).

MWDBE - Any certified minority, women, and disadvantaged business enterprise.

Minority, Women, Disadvantaged Business Enterprise (MWDBE) - A business that is at least fifty-one (51) percent owned and controlled by minority group members or women. An MWDBE is **bona fide** only if the minority group or female ownership interests are real and continuing and not created solely to meet the MWDBE requirement. In addition, the MWDBE must itself perform satisfactory work or services or provide supplies under the contract and not act as a mere conduit. In short, the contractual

relationship must also be **bona fide**.

IV. PROCEDURES FOR CONSTRUCTION CONTRACTS

A. Purpose and Application

1. The general purpose of this Program is to help develop and support Minority, Women, and Disadvantaged Business Enterprises (MBE, WBE, and DBE) by providing opportunities for participation in the performance of all construction contracts financed entirely with PWC funds.
2. This Program shall apply to construction contracts when the PWC's estimated contract cost is \$100,000 or more, except when a contract is exempt from competitive bidding under the General Statutes of North Carolina. Contracts between \$30,000 and \$99,999.99 will also be covered by the exemption.
3. Where contracts are financed in whole or in part with federal or state funds, including grants, loans, or other funding sources containing MBE, WBE, DBE Programs, PWC will follow the federal government or the State of North Carolina. PWC General Manager/CEO or its designee will be responsible for monitoring the Program to ensure the goals are met.
4. Since PWC construction contracts are prepared by the Engineering and Facilities Departments, each of these departments shall prepare such documents with Procurement pre-approved templates for the bidding process, which includes the Program goals as required to implement this Program.
 - a. Within sixty (60) days of the Commission's approval of this Program, the departmental procedures and contract provisions shall be in effect for all bid documents issued after the date of Commission approval.

B. MWDBE Aspirational Goals

1. To implement the purpose of this Program, the goal shall be to award at least fourteen (14) percent of the total of all construction contract award amounts in each fiscal year to MBE firms and at least eleven (11) percent to WBE firms.
2. PWC General Manager/CEO or its designee may determine that higher or lower goals are appropriate on a project-by-project basis, where it can be shown that the type, size, or location of the project will affect the availability of MBE, WBE, or DBE firms, so long as the aggregate of all contracts does not lower the annual goals.

C. Invitation for Bids

1. Bidders shall submit MWDBE information with their bids. Such information shall be subject to verification by MWDBE Program staff before awarding the contract. The information shall include the names of the MWDBEs to be used and the dollar value of each such MWDBE transaction.

2. Contractors, subcontractors, suppliers, or MWDBE members of a joint venture intended to satisfy the PWC's MBE/WBE/DBE goals shall be certified by the State Department of Transportation (DOT) or North Carolina Office of Historically Underutilized Business (HUB).

D. PWC Responsibilities

1. **MWDBE Directory** – The MWDBE Program staff will establish and maintain a directory of certified Minority, Women, and Disadvantaged Business Enterprises. The purpose of the directory is to provide a resource for prime bidders on PWC construction projects who intend to solicit bids from MBE and WBE subcontractors and suppliers to meet PWC's MBE and WBE goals. The directory will not constitute a recommendation or endorsement of any listed firm.

The directory will be developed and maintained by the MWDBE Program Staff.

- a. The directory will include:
 - i. Business name, address, telephone number, and email address;
 - ii. Name(s) of business owner(s);
 - iii. Type of license;
 - iv. NAICS;
 - v. Type of MWDBE certification, and;
 - vi. Certification and expiration date with an acceptable agency.
 - b. PWC shall advertise on a contract-by-contract basis throughout the year as deemed necessary for MWDBE outreach. Advertisements shall be placed with minority/women-focused publications (state and local). Notification will also be sent to community organizations which might have knowledge of MWDBE firms.
 - c. The department heads and MWDBE Program staff should attend local and regional business fairs to promote the MWDBE Program. The departments shall also identify potentially eligible contractors through affirmative action efforts and the normal course of business. The names of identified contractors shall be forwarded to the MWDBE Program staff.
2. **MWDBE Eligibility Standards** – The eligibility of a business is determined by the ownership and control of the business.
 - a. An eligible Minority Business Enterprise owner is a citizen or lawful permanent resident of the United States, a member of a recognized ethnic or racial group, and fifty-one (51) percent owner of the business.
 - b. The eligible ethnic or racial groups are:
 - i. Black/African American
 - ii. Hispanic American
 - iii. Asian American

iv. Native American

- c. An eligible Women Business Enterprise owner is a citizen or lawful resident of the United States and a fifty-one (51) percent owner of the business and is female.

3. **Removal of MWDBE Procedures** - A contractor certified as a MWDBE may be removed from the program directory for, but not limited to, any of the following reasons:

- a. **Change of Status** - PWC General Manager/CEO or its designee may remove a MWDBE if he/she finds that the ownership or control of the business changes so that the business no longer meets the requirements of Section IV, D(2) (b) and (c) above.
- b. **Failure to comply with the MWDBE Program** - The certification of a business as a MWDBE may be removed by PWC General Manager/CEO or its designee if he/she finds any of the following conditions:
- i. That a business has submitted inaccurate, false or incomplete information to PWC;
 - ii. That in performance of a contract, a business has failed to comply with requirements of the contract with PWC;
 - iii. That in performance of a contract, a business has failed to comply with MWDBE requirements of a contract established by a contractor with PWC in response to PWC requirements; or
 - iv. That a business has otherwise failed to comply with the provisions of this MWDBE Program.
- c. **Appeal of Removal** - A business may appeal a determination of a MWDBE by satisfying the eligibility requirements in Section IV, D (2) (b) and (c).
- d. **Pre-bid Meeting or Site Visit** - PWC may hold a pre-bid meeting on formal and informal bid contracts for all prospective bidders, subcontractors, and MWDBEs for the purpose of explaining the provisions of the MWDBE Program, the process for bidding, and the contract to be performed. Available data on MWDBEs interested and/or capable of engaging in the prospective contract shall be made available to prospective bidders, contractors, and subcontractors.

E. Contractor Good-Faith Efforts

The contractor (bidder) shall make good-faith efforts to encourage the participation of MWDBEs in projects prior to submission of bids in order to be considered as a responsive bidder. A good-faith effort shall include, at a minimum, specific affirmative action steps and complete documentation thereof. The following list of factors to determine good-faith effort is not exclusive or exhaustive:

1. Whether the bidder attended any pre-submittal or pre-bid meetings, if scheduled

by PWC;

2. Whether the bidder identified and selected specific items of the project for which the contract could be performed by Minority and/or Women Business Enterprises, to provide an opportunity for participation by those enterprises (including, where appropriate, breaking down contracts into economically feasible units to facilitate MWDBE participation);
3. Whether the bidder advertised, a reasonable time before the date the bids are opened, in one or more daily or minority weekly newspapers or trade associations (i.e., N.C. Minority Business Association), trade journals, or other media;
4. Whether the bidder provided email notice of their interest in bidding on the contract to at least three (3) Minority, Women, or Disadvantaged Business Enterprises (for each identified sub-item of the contract) licensed to provide the specific items of the project a reasonable time prior to the opening of bids;
5. Whether the bidder provided interested Minority, Women, and Disadvantaged Business Enterprises with information about the Plan, specifications, and requirements for the selected subcontracting or material supply work;
6. Whether the bidder contacted PWC's MWDBE Program staff for assistance in identifying minority and women businesses certified with approved public agencies as referenced in Section IV, D (2) (b) and (c);
7. Whether the bidder negotiated in good-faith with Minority, Women, or Disadvantaged Business Enterprises and did not unjustifiably reject as unsatisfactory bids prepared by a Minority, Women, or Disadvantaged Business Enterprises, as defined by PWC;
8. Whether the bidder, where applicable, advised and made efforts to assist interested MWDBEs in obtaining bonds, lines of credit, or insurance required by PWC or contractor;
9. Whether the bidder's efforts to obtain MWDBEs participation could reasonably be expected by PWC to produce a level of participation sufficient to meet the goals of PWC.

Bidders are cautioned that even though their submittal indicates they will meet the MWDBE goals, they should document their good- faith efforts and be prepared to submit this information to protect their eligibility for award of the contract in the event PWC questions whether the good-faith requirement has been met.

10. **Performance of MBE/WBE/DBE Subcontractors and Suppliers** - The MWDBEs listed by the contractor on the Program Affidavits, which is determined by PWC to be certified, shall perform the work and supply the materials for which they are listed unless the contractor has received prior written authorization from PWC to perform the work with other forces or to obtain the materials from other sources.

The contractor shall enter into subcontracts and supply copies of all fully executed subcontracts with each MWDBE listed on the Program Affidavits to PWC's MWDBE Program staff after award of the contract and prior to the issuance of a Notice to Proceed. Any amendments to the subcontracts shall be submitted to the MWDBE Program staff within **five (5) days** of execution.

Authorization to utilize other forces or sources of materials shall be requested by submitting a "Change or Add a Subcontractor Form" for the following reasons:

- a. The listed MWDBE, after having had a reasonable opportunity to do so, fails or refuses to execute a written contract, when such written contract, based upon the general terms, conditions, plans and specifications for the project, or on the terms of such subcontractor's or supplier's written bid, is presented by the contractor.
- b. The listed MWDBE becomes bankrupt or insolvent.
- c. The listed MWDBE fails or refuses to perform his/her subcontract or furnish the listed materials.
- d. The work performed by the listed subcontractor is unsatisfactory according to industry standards and is not in accordance with the plans and specifications; or the subcontractor is substantially delaying or disrupting the progress of the work.

All "Change or Add a Subcontractor Forms" shall be accompanied by good faith efforts documentation as specified on the form.

F. Awarding of Construction Contracts

1. If a construction contract is to be awarded, it shall be awarded in accordance with North Carolina General Statutes to the lowest responsible bidder who complies with all of the prescribed requirements and either:
 - a. Made a good-faith effort to comply with these goals and requirements before the time bids are opened as described above. Where a good-faith effort is claimed by the apparent lowest responsible bidder, the bidder shall be required to submit documentation **WITHIN TWENTY-FOUR (24) HOURS OF PWC'S NOTIFICATION**, which in most instances will occur the day of bid opening to show that the criteria for good-faith efforts have been met, or
 - b. Once a firm is determined to be an eligible MWDBE, and before the contract is awarded, the total dollar value to be paid to the MWDBE shall be evaluated by the MWDBE Program Staff to ensure that it is in accordance with the bidder's proposal.

If the evaluation shows that the bidder has misrepresented MWDBE participation or has not made a good-faith effort to meet the contract goals for MBE or WBE

participation, the bidder may be disqualified.

G. Counting MWDBE Participation Toward Meeting the Aspirational Goals

The degree of participation by MWDBE contractors, subcontractors, suppliers, or joint-venture partners in contract awards shall be counted in the following manner:

1. Once a firm is determined to be an eligible MWDBE contractor in accordance with this Program, the total dollar value of the contract awarded to the MWDBE is counted as participation.
2. The goals can be met by any certified MWDBE contractor, subcontractor, supplier, trucker, or joint-venture partner as listed in PWC and agency directory. All MWDBEs used to meet the goal must be certified by an approved agency and verified by PWC at the time of bid opening. Only certified firms can be counted toward the goal. The standard for certification is set forth in this Program.
3. The total dollar value of a contract with a disadvantaged business owned and controlled by a minority woman is counted toward either the minority goal or the goal for women, but not toward both. The contractor or MWDBE Program staff may choose the goal to which the value is applied.
4. In the case of a joint venture, the joint venture recipient or contractor may count toward its MWDBE goals a portion of the total dollar value of the contract that the MWDBE partner's participation in the joint-venture represents. Credit will be given equal to the minority partner's percentage of ownership in the joint venture. A MWDBE joint-venture partner must be responsible for a clearly defined portion of the work to be performed in addition to satisfying requirements for ownership and control.
5. A recipient or contractor may count toward its MWDBE goals only expenditures to MWDBEs whose ownership interests are real and continuing and not created solely to meet PWC's goals for participation, and that perform a commercially useful function in the work of a contract. A MWDBE is considered to perform a commercially useful function when it is responsible for execution of a distinct element of the work of a contract and carries out its responsibilities by actually performing, managing, and supervising the work involved. To determine whether a MWDBE is performing a commercially useful function, the MWDBE Program staff shall evaluate the amount of work subcontracted, industry practices, and other relevant factors. Consistent with normal industry practices, an MWDBE may enter into subcontracts. If a MWDBE contractor subcontracts a significantly greater portion of the work of the contract than would be expected on the basis of normal industry practices, the MWDBE shall be presumed not to be performing a commercially useful function. Evidence to rebut this presumption may be presented to the MWDBE Program staff. The MWDBE may present evidence to rebut this presumption. The MWDBE Program staff decision on the rebuttal of this presumption is subject to review by PWC General Manager/CEO or its designee. Once a contractor is determined to be an eligible MWDBE in accordance with this section, the total dollar value of the contract awarded to MWDBE is counted toward the applicable MWDBE goals, except as provided in

the provisions of this section.

6. A contractor may count toward its MWDBE goals expenditures for materials and supplies obtained from MWDBE suppliers and manufacturers, provided that the MWDBE assumes the actual and contractual responsibility for the provision of the materials and supplies.

H. Documentation of Attainment of MWDBE Participation Requirements

In order that PWC General Manager/CEO or its designee may make a recommendation to PWC as to the responsiveness of bidders, bidders shall be required to submit the following information on each MWDBE-related subcontract:

1. A description of the subcontract and purchase(s) of significant equipment and supplies to be used to perform the subcontract or prime contract, including the name and address of each MWDBE firm selected, and the name and telephone number of a contact person;
2. The dollar amount of participation of each MWDBE;
3. A statement of intent from the MWDBE subcontractor or material supplier as;
 - a. Identified in Section IV, H(1) above that they intend to contract or supply the materials, or
 - b. Sworn statements, with appropriate documentation, showing that the contractor made a good-faith effort to comply with the MWDBE Program in accordance with Section IV, E of this Program.

V. PROCEDURES FOR ARCHITECTURE & ENGINEERING (A&E) CONTRACTS

A. Purpose and Application

1. The general purpose (goal) of this Program is to help develop and support MWDBEs by providing opportunities for participation in the performance of PWC's A&E contracts financed entirely with PWC funds.
2. This Program applies to all A&E contracts except contracts in those unique circumstances where written exemption of particular contracts is determined as an exception, and less than fifty thousand dollars (\$50,000.00) by PWC General Manager/CEO. PWC General Manager/CEO or its designee will be responsible for administering and monitoring the Program to ensure that appropriate action(s) are taken in efforts of achieving the goals.
3. Where contracts are funded in whole or in part with federal or state funds and the grants, loans, or other funding sources containing MWDBE Program requirements, PWC General Manager/CEO or its designee will be responsible for monitoring the Program to ensure the goals are met.

4. Since PWC Request for Qualifications (RFQ) are prepared by the Engineering and Facilities Departments, each of these departments shall prepare such documents with Procurement pre-approved templates for the qualification-based selection process, which includes the Program goals as required to implement this Program.

B. MWDBE Aspirational Goals

1. To implement this Program, the goal shall be to award six percent (6%) of the total A&E contract dollars awarded in each fiscal year to MBE firms and five percent (5%) to WBE firms. The goals will become effective on the date that PWC approves the Program and continue for a period of five (5) years.

C. Request for Qualifications

1. It is not required that contracts under \$50,000 meet the contract goal. When possible, at least twenty-five (25) percent of the firms notified of the contract opportunity shall be MWDBE. A list of available firms will be provided by the MWDBE Program staff to the Procurement Advisor and Department. The MWDBE Program staff shall track and report the firms that are notified and that provide submittals.

D. PWC Responsibilities

1. Identification of MWDBE Firms

- a. The MWDBE Program staff will establish and maintain a directory of certified Minority, Women, and Disadvantaged Business Enterprises. The purpose of the directory is to provide a resource on PWC A&E projects. The directory will not constitute a recommendation or endorsement of any listed firm. The directory will be developed and maintained by the MWDBE Program Staff.
- b. The directory will include:
 - i. Business name, address, telephone number, and email address;
 - ii. Name(s) of business owner(s);
 - iii. Type of license;
 - iv. NAICS;
 - v. Type of MWDBE certification, and;
 - vi. Certification and expiration date with an acceptable agency.
- c. PWC shall advertise on a contract-by-contract basis throughout the year as deemed necessary for MWDBE outreach. Advertisements shall be placed with minority/women-focused publications (state and local). Notification will also be sent to community organizations which might have knowledge of MWDBE firms.

- d. The department heads and MWDBE Program staff should attend local and regional business fairs to promote the MWDBE Program. The departments shall also identify potentially eligible firms through affirmative action efforts and the normal course of business. The names of identified firms shall be forwarded to the MWDBE Program staff.

E. Meeting MWDBE Aspirational Goals

1. Goals must be met by awarding contracts to certified MWDBE firms. The MWDBE must be certified at the time of the contract award. MWDBE firms not certified at the time of the contract award will not be counted towards MWDBE goals. MWDBE goals may be met by a certified joint venture or partnership. In the case of joint ventures or partnerships, MWDBE participation counted toward the goal will be equal to the percentage of the total dollar value of the contract that the MWDBE partner is responsible for performing.

F. Counting MWDBE Participation

1. The total dollar value of a contract with a disadvantaged business owned and controlled by a minority woman is counted toward either the minority goal or the goal for women, but not toward both. The contractor or MWDBE Program staff may choose the goal to which the value is applied.
2. If a determination is made by the MWDBE Program staff that the goals have not been met, the prime service provider will be required to submit a good-faith effort statement prior to PWC awarding the contract.

G. Provider Good-Faith Efforts

The following is a list of the efforts that should be made by the prime A&E firm to encourage MWDBE participation. In order to receive credit for having made "good faith efforts", the prime A&E firm should document all actions taken to include the following:

1. Attending pre-bid meetings scheduled by the department;
2. Identifying selected specific items of the project which could be executed by a MWDBE;
3. Soliciting MWDBE A&E firm participation in a reasonable time before the solicitations are due through advertisements in circulation media, trade publications, and minority-focused media;
4. Contacting local firms, firms owned by minorities or women, and associations or business development centers which disseminate information to local businesses and businesses owned by minorities or women in a timely manner to allow sufficient time for MWDBEs to respond;
5. Following up on initial solicitations of interest by contacting the MWDBE to determine whether the MWDBE was interested in performing specific items of the

project;

6. Attempting to enter into joint venture or partnership arrangements with MWDBEs and provide interested MWDBEs with information about the requirements for the project;
7. Providing assistance to MWDBEs in the review of qualification submittal and work to be done by sub-A&E firms;
8. Using available directories of certified MWDBEs and other available resources;
9. Ensuring that the firm negotiated in good faith with the MWDBE and did not unjustifiably reject as unsatisfactory qualifications prepared by any Minority, Women, or Disadvantaged Business Enterprise;
10. Making every effort to obtain Minority, Women, or Disadvantaged Business Enterprise participation that could reasonably be expected to produce a level of participation sufficient to meet the goals of PWC; and
11. Providing interested minority, women, and disadvantaged businesses with information relative to project requirements.

H. Documenting Good-Faith Efforts

If the prime A&E firm does not meet the goals for MWDBE participation at the time of qualification submittal, then the following documents indicating "good-faith efforts" should be submitted as a minimum:

1. A report of all proposals received by the prime service provider from MWDBE sub-A&E firms must indicate the action taken by the prime A&E firm in response to the qualification submittal. In cases where proposals have been rejected, the reason for rejection must be indicated.
2. Documentation of efforts to enter into agreements with MWDBEs for sub-A&E work or arrangements for joint ventures, partnerships, or other multi-entity relationships. Also included should be a statement of why agreements or arrangements were not made.
3. Proof of contact with MWDBEs and associations or business development centers that disseminate information to MWDBEs.
4. A copy of emails or notices sent to groups in Section VI, J(3) above notifying them of the firm's intent to submit a qualification submittal to PWC. The emails or notices should indicate the areas of work available for sub-A&E firms.
5. Description of assistance provided to MWDBEs in review of the qualification submittal and work to be done by sub-A&E firms.
6. Description of the use made by firms of available resources such as directories of MWDBEs.

7. Documentation of advertisements sent to general circulation media, trade publications, and minority-focused media.
8. Proof of attendance at any pre-bid meeting.

If the prime A&E firm fails to meet the MWDBE goals with its proposed project team and cannot provide documentation of "good-faith efforts", these failures will be noted to the involved department by the MWDBE Program Staff, and the firm may be disqualified.

VI. PROCEDURES FOR PURCHASE CONTRACTS

A. Purpose and Application

1. The general purpose of this Program is to help develop and support Minority, Women, and Disadvantaged Business Enterprises (MBE, WBE, and DBE) by providing opportunities for participation in purchase contracts financed entirely with PWC funds.
2. This Program shall apply to purchase contracts over \$30,000 for apparatus, materials, supplies and purchase contracts for goods where the patent-holder is not the sole supplier. PWC General Manager/CEO or its designee will be responsible for monitoring the Program to ensure the goals are met.
3. Where contracts are funded in whole or in part with federal or state funds and the grants, loans, or other funding sources containing MWDBE Program requirements, PWC General Manager/CEO or its designee will be responsible for monitoring the Program to ensure the goals are met.
4. Since PWC purchase contracts are prepared by various departments, each of these departments shall prepare such documents with Procurement pre-approved templates for the quote or bid process, which includes the goals as required to implement this Program. PWC Departments shall document and provide to the MWDBE Program staff a list of all providers notified and responses received for informal purchases.

B. MWDBE Aspirational Goals

1. To implement the purpose of this Program, the goal shall be to award at least four (4) percent of the total of all purchase contract award amounts in each fiscal year to MBEs and at least four (4) percent to WBE firms. It is further the intent of PWC to encourage, to the extent allowed the use of local vendors (defined as located within Cumberland, Hoke, or Harnett County) whenever doing so is consistent with the requirements under G.S. 143-129.

C. Request for Quotes or Invitation for Bids

1. The various departments soliciting goods will be responsible for contacting from the directory at least one MBE and one WBE for a price quotation of \$30,000 or more on each purchase contract with MWDBE availability.

2. A list of available MWDBEs will be provided by the MWDBE Program staff to the Procurement Advisor and Department. The MWDBE Program staff shall track and report the MWDBEs that are notified and that provide submittals.

D. PWC Responsibilities

1. Identification of MWDBEs

- a. The MWDBE Program staff will establish and maintain a directory of certified Minority, Women, and Disadvantaged Business Enterprises. The purpose of the directory is to provide a resource for on PWC purchase contracts. The directory will not constitute a recommendation or endorsement of any listed supplier. The directory will be developed and maintained by the MWDBE Program Staff.
 - b. The directory will include:
 - i. Business name, address, telephone number, and email address;
 - ii. Name(s) of business owner(s);
 - iii. NAICS;
 - iv. Type of MWDBE certification, and;
 - v. Certification and expiration date with an acceptable agency.
 - c. PWC shall advertise on a contract-by-contract basis throughout the year as deemed necessary for MWDBE outreach. Advertisements shall be placed with minority/women-focused publications (state and local). Notification will also be sent to community organizations which might have knowledge of MWDBE suppliers.
 - d. The department heads and MWDBE Program staff should attend local and regional business fairs to promote the MWDBE Program. The departments shall also identify potentially eligible suppliers through affirmative action efforts and the normal course of business. The names of identified suppliers shall be forwarded to the MWDBE Program staff.
2. **MWDBE Eligibility Standards** – The eligibility of a business is determined by the ownership and control of the business.
- a. An eligible Minority Business Enterprise owner is a citizen or lawful permanent resident of the United States, a member of a recognized ethnic or racial group, and fifty-one (51) percent owner of the business.
 - b. The eligible ethnic or racial groups are:
 - i. Black/African American
 - ii. Hispanic American
 - iii. Asian American
 - iv. Native American

- c. An eligible Women Business Enterprise owner is a citizen or lawful resident of the United States and a fifty-one (51) percent owner of the business and is female.
- 3. **Removal of MWDBE Procedures** - A supplier certified as a MWDBE may be removed from the program directory for, but not limited to, any of the following reasons:
 - a. **Change of Status** - PWC General Manager/CEO or its designee may remove a MWDBE if he/she finds that the ownership or control of the business changes so that the business no longer meets the requirements of Section IV, D(2) (b) and (c) above.
 - b. **Failure to comply with the MWDBE Program** - The certification of a business as a MWDBE may be removed by PWC General Manager/CEO or its designee if he/she finds any of the following conditions:
 - i. That a business has submitted inaccurate, false or incomplete information to PWC;
 - ii. That in performance of a contract, a business has failed to comply with requirements of the contract with PWC;
 - iii. That in performance of a contract, a business has failed to comply with MWDBE requirements of a contract established by a contractor with PWC in response to PWC requirements; or
 - iv. That a business has otherwise failed to comply with the provisions of this MWDBE Program.
 - c. **Appeal of Removal** - A business may appeal a determination of a MWDBE by satisfying the eligibility requirements in Section IV, D (2) (b) and (c).
 - d. **Pre-bid Meeting or Site Visit** - PWC may hold a pre-bid meeting on formal and informal bid contracts for all prospective bidders, subcontractors, and MWDBEs for the purpose of explaining the provisions of the MWDBE Program, the process for bidding, and the contract to be performed. Available data on MWDBEs interested and/or capable of engaging in the prospective contract shall be made available to prospective bidders, contractors, and subcontractors.

E. Award of Purchase Contracts

- 1. If a purchase contract is to be awarded, it shall be awarded in accordance with North Carolina General Statutes and/or other applicable PWC, Commission, and State regulations.

VII. PROCEDURES FOR PROFESSIONAL, GENERAL (OTHER) SERVICE CONTRACTS

A. Purpose and Application

1. The general purpose (goal) of this Program is to help develop and support MWDBEs by providing opportunities for participation in the performance of PWC's professional service contracts and general (other) service contracts (hereinafter referred to as service contracts).
2. This Program applies to all service contracts except contracts under \$30,000, and in those unique circumstances where PWC General Manager/CEO or its designee determines that an exception is necessary.
3. Where contracts are funded in whole or in part with federal or state funds and the grants, loans, or other funding sources containing MWDBE Program requirements, PWC General Manager/CEO or its designee will be responsible for monitoring the Program to ensure the goals are met.
4. PWC General Manager/CEO or its designee will be responsible for administering and monitoring the Program to ensure that appropriate action(s) are taken in efforts of achieving the goals.

B. MWDBE Aspirational Goals

1. To implement this Program, the goal shall be to award nine percent (9%) of the total service contract dollars awarded in each fiscal year to MBE firms and four percent (4%) to WBE firms. The goals will become effective on the date that PWC approves the Program and continue for a period of five (5) years.

C. PWC's Responsibilities

1. Identification of MWDBE Firms

- a. The MWDBE Program staff shall establish and maintain a directory of certified MWDBE service providers that shall be made available to all departments to assist them in identifying appropriate MWDBE service providers that can be used to meet PWC's MWDBE goals. The directory shall include the businesses which provide the services routinely procured by PWC and the NAICS which the businesses are capable of providing. The directory will not constitute a recommendation or endorsement of any listed business. The directory will include:
 - i. Business name, address, and telephone number;
 - ii. Name(s) of business owner(s);
 - iii. NAICS of services available;
 - iv. Type of MWDBE certification, and;
 - v. Certification and expiration date with an acceptable agency.
- b. PWC shall provide a list of opportunities at least 30 days prior to each fiscal year (July) for MWDBE service providers. Advertisements shall

be placed with minority/women-focused publications (state and local). Notification will also be sent to community organizations that might have knowledge of MWDBE firms. Interested MWDBEs shall provide a letter of interest within **14 calendar days** of the advertisement.

- c. For opportunities that arise throughout the fiscal year, PWC shall provide an Advertisement for opportunity to but not limited to MWDBE service providers within the MWDBE directory and identified MWDBEs from the Disparity Study. Advertisements shall be placed with minority/women-focused publications (state and local). Notification will also be sent to community organizations that might have knowledge of MWDBE firms. Interested MWDBEs shall provide a letter of interest within **7 calendar days**.
- d. The department heads and MWDBE Program staff should attend local and regional business fairs to promote the MWDBE Program. The departments shall also identify potentially eligible service providers through affirmative action efforts and the normal course of business. The names of identified businesses shall be forwarded to the MWDBE Program staff.

D. Request for Proposals

1. MWDBE contract goals shall be set for service contracts over \$30,000.00. The request for proposals shall state the contract goals of four (4) percent for both MWDBE Professional and General Service contractors.
2. Contracts under \$30,000 and contracts without letters of interest are not required to meet the contract goal.
3. A list of available service providers will be provided by the MWDBE Program staff to the Procurement Advisor(s) and department(s). The MWDBE Program staff shall track and report the service providers that are notified and that provide proposals.

E. Meeting MWDBE Aspirational Goals

1. Goals must be met by awarding contracts to certified MWDBE service providers. The MWDBE must be certified at the time of the contract award. MWDBE service providers not certified at the time of the contract award will not be counted towards MWDBE goals. MWDBE goals may be met by a certified joint venture or partnership. In the case of joint ventures or partnerships, MWDBE participation counted toward the goal will be equal to the percentage of the total dollar value of the contract that the MWDBE partner is responsible for performing.

F. Counting MWDBE Participation

1. The total dollar value of a contract with a disadvantaged business owned and controlled by a minority woman is counted toward either the minority goal or the goal for women, but not toward both. The contractor or MWDBE Program staff

may choose the goal to which the value is applied.

2. If a determination is made by the MWDBE Program staff that the goals have not been met, the prime service provider will be required to submit a good-faith effort statement prior to PWC awarding the contract.

G. Provider Good-Faith Efforts

The following is a list of the efforts that should be made by the prime service provider to encourage MWDBE participation. In order to receive credit for having made "good faith efforts", the prime service provider should document all actions taken to include the following:

1. Attending pre-bid meetings scheduled by the department;
2. Identifying selected specific items of the project which could be executed by a MWDBE;
3. Soliciting MWDBE service provider participation in a reasonable time before the proposals are due through advertisements in circulation media, trade publications, and minority-focused media;
4. Contacting local firms, firms owned by minorities or women, and associations or business development centers which disseminate information to local businesses and businesses owned by minorities or women in a timely manner to allow sufficient time for MWDBEs to respond;
5. Following up on initial solicitations of interest by contacting the MWDBE to determine whether the MWDBE was interested in performing specific items of the project;
6. Attempting to enter into joint venture or partnership arrangements with MWDBEs and provide interested MWDBEs with information about the requirements for the project;
7. Providing assistance to MWDBEs in the review of proposals and work to be done by sub-service providers;
8. Using available directories of certified MWDBEs and other available resources;
9. Ensuring that the proposer negotiated in good faith with the MWDBE and did not unjustifiably reject as unsatisfactory quotes prepared by any Minority, Women, or Disadvantaged Business Enterprise;
10. Making every effort to obtain Minority, Women, or Disadvantaged Business Enterprise participation that could reasonably be expected to produce a level of participation sufficient to meet the goals of PWC; and
11. Providing interested minority, women, and disadvantaged businesses with information relative to project requirements.

I. Documenting Good-Faith Efforts

If the prime service provider does not meet the goals for MWDBE participation at the time the proposals are due, then the following documents indicating "good-faith efforts" should be submitted as a minimum:

1. A report of all proposals received by the prime service provider from MWDBE sub-providers must indicate the action taken by the prime service provider in response to the proposal. In cases where proposals have been rejected, the reason for rejection must be indicated.
2. Documentation of efforts to enter into agreements with MWDBEs for sub-provider work or arrangements for joint ventures, partnerships, or other multi-entity relationships. Also included should be a statement of why agreements or arrangements were not made.
3. Proof of contact with MWDBEs and associations or business development centers that disseminate information to MWDBEs.
4. A copy of emails or notices sent to groups in Section VI, J(3) above notifying them of the firm's intent to submit a qualification submittal to PWC. The emails or notices should indicate the areas of work available for sub-providers.
5. Description of assistance provided to MWDBEs in review of the qualification submittal and work to be done by the sub-provider.
6. Description on use made by firms of available resources such as directories of MWDBEs.
7. Documentation of advertisements sent to general circulation media, trade publications, and minority-focused media.
8. Proof of attendance at any pre-bid meeting.

If the prime service provider fails to meet the MWDBE goals with its proposed project team and cannot provide documentation of "good-faith efforts", these failures will be noted to the involved department by the MWDBE Program Staff, and the service provider may be disqualified.

VIII. UTILIZATION OF JOINT VENTURE

PWC is committed to promoting the utilization of joint venturing amongst business enterprises and to support, encourage, and offer procurement opportunities to support utilization when available so that business enterprises can meet capacity development.

The purpose of Joint Venturing is to connect high potential MWDBEs with a Prime Contractor that will supplement their growth and development. Joint Venturing is seen as an important approach to help MWDBEs compete for larger contracts. PWC conducts many outreach events to connect certified MWDBEs with PWC decision makers and prime contractors. PWC shall provide targeted outreach, training, and technical support

to MWDBEs and urge Prime contractors to provide an equivalent level of outreach and support when joint venturing is available. PWC's mission is to provide an innovative program to the industry that focuses on the accelerated growth of diverse partnerships.

IX. MWDBE REPORTING PROCEDURE

1. The MWDBE Program staff shall submit quarterly progress reports to PWC Departments. The quarterly progress reports shall be prepared by the MWDBE Program staff from information (i.e. pay applications, MWDBE forms, and requisition checklist form) submitted by each department involved in procurement within thirty (30) days following the period (each quarter). Progress reports shall indicate the type of procurement contract (i.e., construction, A&E, purchase, professional services, or general services) and shall include the following:
 - vi. Number and dollar value of total procurement contracts;
 - vii. Number and dollar value of all procurement contracts awarded to MWDBEs by the department;
 - viii. Where goals are not met, the progress report shall specify the reasons and include recommendations for increasing participation.
2. PWC General Manager/CEO or its designee shall submit an annual report to Commission. The report shall include the total number of procurement contracts by departments and the dollar value of all contracts with MWDBE participation. The level of MWDBE participation shall be reported annually.

**FAYETTEVILLE PUBLIC WORKS COMMISSION'S
MWDBE COMPLIANCE PROVISIONS**

APPLICATION:

The requirements of Fayetteville Public Works Commission (PWC) Minority, Women, and Disadvantaged Business Enterprise (MWDBE) Program for participation specific contracts are hereby made part of the Contract Documents. Copies of the Program may be obtained from:

Fayetteville Public Works Commission
Economic Inclusion Programs
P.O. Box 1089
Fayetteville, North Carolina 28302
Phone (910) 223-4016 Fax (910) 483-1429
E-mail: EIProgram@faypwc.com

NCDOT DBE Directory: www.ebs.nc.gov/VendorDirectory

HUB Directory: <https://ncadmin.nc.gov/businesses/hub>

MWDBE Compliance Requirements:

1. The Bidder shall provide, with their Bid Form, at the time bids are due, the documents set forth below, properly executed. Returning executed copies indicates and establishes that the Bidder understands and agrees to any incorporated MWDBE contract provisions.
2. All Bidders must provide with their Bid Form, at the time bids are due, a properly completed and executed copy of **either:**
 - Affidavit A – Listing of Good-Faith Efforts **OR**
 - *Affidavit B – Intent to Self-Perform with Own Workforce.

*Affidavit B should **only** be used if the Contractor will perform **ALL Elements** of the Work on this project with their own forces **AND** will complete **ALL Elements** of this project **WITHOUT** the use of subcontractors, material suppliers, or providers of professional services.
3. Upon being identified as the apparent lowest responsive, responsible Bidder, a Bidder shall, within twenty-four (24) hours of PWC's notification provide a properly completed and executed copy of **either:**
 - Affidavit C – Percentage of MWDBE Participation **OR**
 - Affidavit D – Good-Faith Efforts.
4. All Bidders must provide with their Bid Form, at the time bids are due, a properly completed and executed copy of Affidavit E- Identification of MWDBE/Local Participation Form

All written statements, certifications, or intentions made by the Bidder shall become a part of the agreement between the Contractor and Fayetteville Public Works Commission for performance of this contract.

SUBCONTRACTOR PAYMENT REQUIREMENTS:

North Carolina General Statutes 143-134.1 (N.C.G.S.) states that the percentage of retainage on payments made by the prime contractor to the subcontractor shall not exceed the percentage of retainage on payments made by the Fayetteville Public Works Commission to the prime contractor. Failure to comply with this provision shall be considered a breach of the contract, and the contract may be terminated in accordance with the termination provisions of the contract.

The Contractor shall provide an itemized statement of payments to each MWDBE subcontractor before final payment is processed.

The Contractor shall provide an itemized statement of payments to each NON-MWDBE subcontractor before final payment is processed.

Contractor

Signature

Printed Name

Title

Date

Affidavit A: Listing of the Good Faith Efforts

Affidavit of _____
(Name of Bidder)

I have made a good faith effort to comply under the following areas checked:

Total Available GFE Points: 155		Minimum Number GFE Points Required: 50
Points		
10	Contacting minority businesses that reasonably could have been expected to submit a quote and that were known to the contractor or available on State or local government-maintained lists at least 10 days before the bid or proposal date and notifying them of the nature and scope of the work to be performed.	
10	Making the construction plans, specifications and requirements available for review by prospective minority businesses or providing these documents to them at least 10 days before the bid or proposals are due.	
15	Breaking down or combining elements of work into economically feasible units to facilitate minority participation.	
10	Working with minority trade, community, or contractor organizations identified by the Office for Historically Underutilized Businesses and included in the bid documents that provide assistance in recruitment of minority businesses.	
10	Attending any pre-bid meetings scheduled by the public owner.	
20	Providing assistance in getting required bonding or insurance or providing alternatives to bonding or insurance for subcontractors.	
15	Negotiating in good faith with interested minority businesses and not rejecting them as unqualified without sound reasons based on their capabilities. Any rejection of a minority business based on lack of qualification should have the reasons documented in writing.	
25	Providing assistance to an otherwise qualified minority business in need of equipment, loan capital, lines of credit, or joint pay agreements to secure loans, supplies, or letters of credit, including waiving credit that is ordinarily required. Assisting minority businesses in obtaining the same unit pricing with the bidder's suppliers in order to help minority businesses in establishing credit.	
20	Negotiating joint venture and partnership arrangements with minority businesses in order to increase opportunities for minority business participation on a public construction or repair project when possible.	
20	Providing quick pay agreements and policies to enable minority contractors and suppliers to meet cash-flow demands.	
Total GFE Points (Claimed by Bidder):		Total GFE Points (Assessed by PWC):

In accordance with NCGS 143-128.2(d) the undersigned will enter into a formal agreement with the firms listed in the Identification of Small Disadvantaged Business Participation schedule conditional upon execution of a contract with the Owner. Failure to abide by any applicable statutory provision may constitute a breach of the contract. The undersigned hereby certifies that he or she has read the terms of the MWDBE business commitment and is authorized to bind the Bidder to the commitment herein set forth.

Date: _____ Name of Authorized Officer: _____

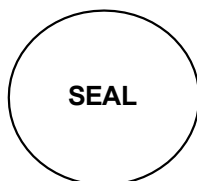

State of North Carolina, County of _____

Subscribed and sworn to before me this _____ day of 20__

Notary Public _____

My commission expires _____

Affidavit B: Intent to Perform Contract with Own Workforce

Affidavit of _____
(Name of Bidder)

I hereby certify that it is our intent to perform 100% of the work required for contract:

(Name of Project)

In making this certification, the Bidder states that the Bidder does not customarily subcontract elements of this type project, and normally performs and has the capability to perform and will perform **all elements of the work** on this project with his/her own current workforces; and will complete all elements of this project **without** the use of subcontractors, material suppliers, or providers of professional services.

The Bidder agrees to provide any additional information or documentation requested by the Owner in support of the above statement.

The undersigned hereby certifies that he or she has read this certification and is authorized to bind the Bidder to the commitments herein contained.

Date: _____ Name of Authorized Officer: _____

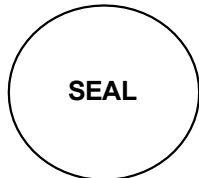

State of North Carolina, County of _____

Subscribed and sworn to before me this _____ day of 20____

Notary Public _____

My commission expires _____

Affidavit C: Percentage of MWDBE Participation

Affidavit of _____
(Name of Bidder)

I hereby certify that on contract: _____
(Name of Project)

\$ _____
(Dollar Amount of Total Bid)

I will expend a minimum of _____% of the total dollar amount of the contract with Minority, Women, and Disadvantaged Business Enterprises (MWDBE). MWDBEs will be employed as subcontractors, vendors, or providers of professional services. Such work will be subcontracted to the following firms listed below.

<u>Name, Address, & Phone No.</u>	<u>*MWDBE Category</u>	<u>NAICS</u>	<u>Dollar Value</u>	<u>% of Contract</u>

*MWDBE categories: Black-African Americans (B), Hispanic-Americans (H), Asian- Americans (A), Native-Americans (I), Women (F), Socially/Economically Disadvantaged (D)

Pursuant to NCGS 143-128.2(d), the undersigned will enter into a formal agreement with MWDBEs for work listed in this schedule conditional upon execution of a contract with the Owner. Failure to fulfill this commitment may constitute a breach of the contract.

The undersigned hereby certifies that he or she has read the terms of this commitment and is authorized to bind the Bidder to the commitment herein set forth.

Date: _____ Name of Authorized Officer: _____

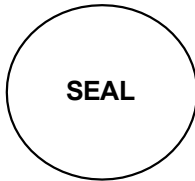

State of North Carolina, County of _____

Subscribed and sworn to before me this _____ day of 20____

Notary Public _____

My commission expires _____

Affidavit D: Good Faith Efforts

If Owner determines using reasonable discretion that Affidavit C is insufficient, Bidder agrees to provide the following information regarding any good-faith efforts.

<u>Name, Address, & Phone No.</u>	<u>*MWDBE Category</u>	<u>NAICS</u>	<u>Dollar Value</u>

*MWDBE categories: Black-African Americans (B), Hispanic-Americans (H), Asian- Americans (A), Native-Americans (I), Women (F), Socially/Economically Disadvantaged (D)

Bidder may be requested to provide documentation of the Bidder's good-faith efforts. Examples of documentation may include the following:

- a. Copies of solicitations for quotes to MWDBEs. Each solicitation may include a specific description of the work to be subcontracted, location where bid documents can be reviewed, representative of the Prime Bidder to contact, and location, date and time when quotes must be received.
- b. Copies of quotes or responses received from each firm responding to the solicitation.
- c. A telephone log of follow-up calls to each firm sent a solicitation.
- d. For subcontracts where a MWDBE is not considered the lowest responsible sub-bidder, copies of quotes received from all firms submitting quotes for that particular subcontract.
- e. Documentation of any contacts or correspondence to MWDBE, community or contractor organizations in an attempt to meet the goal.
- f. Copy of pre-bid roster.
- g. Letter documenting efforts to provide assistance in obtaining required bonding or insurance for MWDBEs.
- h. Letter detailing reasons for rejection of a MWDBE due to lack of qualification.
- i. Letter documenting proposed assistance offered to MWDBEs in need of equipment, loan capital, lines of credit, or joint pay agreements to secure loans, supplies, or letter of credit, including waiving credit that is ordinarily required.

Failure to provide the documentation as listed in these provisions may result in rejection of the bid and award to the next lowest responsible and responsive Bidder.

Date: _____ Name of Authorized Officer: _____



State of North Carolina, County of _____

Subscribed and sworn to before me this _____ day of 20__

Notary Public _____

My commission expires _____

Affidavit E: Identification of MWDBE/Local Participation

(Name of Bidder)

I hereby certify that on contract: _____

(Name of Project)

We will use the following Minority, Women, and Disadvantaged Business Enterprises (MWDBE), and Local (Cumberland, Hoke, Harnett County) as construction subcontractors, vendors, suppliers, or providers of professional services.

<u>Name, Address, & Phone No.</u>	<u>*MWDBE Category / **Local</u>	<u>NAICS</u>	<u>Dollar Value</u>

*MWDBE categories: Black-African Americans (B), Hispanic-Americans (H), Asian- Americans (A), Native-Americans (I), Women (F), Socially/Economically Disadvantaged (D)

**Local: Fayetteville Metropolitan Statistical Area (MSA) comprising of Cumberland County, Hoke County, and Harnett County. PWC is requesting this information for reporting purposes only, and use of local entities will not be considered for compliance with the requirements of the MWDBE Program.

The total value of MWDBE/local business contracting will be \$ _____

Date: _____ Name of Authorized Officer: _____



State of North Carolina, County of _____

Subscribed and sworn to before me this _____ day of 20____

Notary Public _____

My commission expires _____

**FAYETTEVILLE PUBLIC WORKS COMMISSION
MWDBE ADD / CHANGE FORM**

If a MWDBE subcontractor fails to complete work under the subcontract for any reason, the recipient must require the prime contractor to employ the good faith efforts set forth in the MWDBE Program if soliciting a replacement or additional subcontractor.

For MWDBE Change Request, please provide all information below:

Prime Contractor: _____

Subcontracted Work: _____

Previous Subcontractor: _____

Reason this for change request:

New Subcontractor: _____ MWDBE Category: _____

To Add MWDBE Subcontractor/Subcontracted work:

If this is a new trade being subcontracted or a subcontractor that was not documented in the original Project Bid Information submittal, then good faith efforts to solicit a MWDBE must be documented, as the original MWDBE instructions indicate. Please provide all good faith efforts below showing all the MWDBE firms contacted to perform this work along with any additional good faith efforts or evidence that there are not reasonably available firms in the work area. PWC's MWDBE Program requires that good faith efforts are to be carried out to the fullest extent practicable. If solicitations were not carried out due to being impracticable, please attach this explanation to this form.

Name, Address, & Contact Information	MBE or WBE and Certifying agency	How was this firm contacted (email, letter, or Phone) and what was the result of the solicitation? *

*Must submit copies of emails or letters. If phone calls were made this sheet can serve as documentation of calls

Date: _____ Name of Authorized Officer: _____

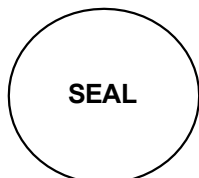

State of North Carolina, County of _____

Subscribed and sworn to before me this _____ day of 20__

Notary Public _____

My commission expires _____

SMALL LOCAL SUPPLIER / MWDBE SUBCONTRACTOR DISCLOSURE FORM

Contractor: _____
 Address & Phone: _____
 Project: _____
 Name: _____
 Pay Application # _____

Please complete the below form by providing the necessary information for the payments made to each subcontractor, vendor, or supplier for the work associated with the identified pay application. This form must be fully completed and attached to each pay application.

Firm Name, Address, and Contact Information	Payment Amount	Type of Work/Commodity (Include NAICS Code)

Signature

Printed Name

Title

Date

SECTION B - CONTRACT EXECUTION DOCUMENTS

***** THIS PAGE WAS INTENTIONALLY LEFT BLANK *****

NOTICE OF AWARD

TO: _____

PROJECT DESCRIPTION: VARIOUS SEWER MANHOLE REHABILITATION (CIP) – FIBERGLASS REINFORCED EPOXY

The OWNER has considered the BID submitted by you for the above described work in response to its Advertisement for Bids dated _____ and Instructions to Bidders.

You are hereby notified that your BID has been accepted for items in the amount of \$_____.

You are required by the Instructions to Bidders to execute the Agreement and furnish the required Performance Bond, Payment Bond, and Certificates of Insurance within ten (10) calendar days from the date of this NOTICE to you.

If you fail to execute said Agreement and to furnish said Bonds within ten (10) days from the date of this Notice, said Owner will be entitled to consider all your rights arising out of the OWNER's acceptance of your BID as abandoned and as a forfeiture of your Bid Bond. The Owner will be entitled to such other rights as may be granted by law.

You are required to return an acknowledged copy of this NOTICE OF AWARD to the OWNER.

Dated this _____ day of _____, 2023.

**OWNER: FAYETTEVILLE PUBLIC WORKS COMMISSION
FAYETTEVILLE, NC**

**BY: Candice S. Kirtz
TITLE: Director of Supply Chain**

ACCEPTANCE OF AWARD

VARIOUS SEWER MANHOLE REHABILITATION (CIP) – FIBERGLASS REINFORCED EPOXY

Receipt of the preceding NOTICE OF AWARD is hereby acknowledged this the _____ day of _____, 2023.

(CONTRACTOR)

By: _____

Title: _____

- END OF SECTION -

CONSTRUCTION AGREEMENT RV 7.17.23

PERFORMANCE BOND

Date of Execution: _____

Name of Principal: _____

(Contractor)

Name of Surety: _____

Name of Contracting

Body: Fayetteville Public Works Commission, Fayetteville, N.C.

Amount of Bond: _____

PROJECT: VARIOUS SEWER MANHOLE REHABILITATION (CIP) – FIBERGLASS REINFORCED EPOXY

KNOW ALL MEN BY THESE PRESENTS, That We, the Principal and Surety above named, are held and firmly bound unto the above named Contracting Body, hereinafter called the Contracting Body, in the penal sum of the amount stated above the payment of which sum well and truly to be made, we bind ourselves, our heirs, executors, administrators, and successors, jointly and severally, firmly by these present.

THE CONDITION OF THIS OBLIGATION IS SUCH that whereas the Principal entered into a certain Contract with the Contracting Body, identified as shown above and hereto attached.

NOW, THEREFORE, if the Principal shall well and truly perform and fulfill all the undertakings, covenants, terms, conditions, and agreements of said Contract during the original term of said Contract and any extensions there of that may be granted by the Contracting Body, with or without notice to the Surety, and during the life of any Guaranty required under the Contract, and shall also well and truly perform and fulfill all the undertakings, covenants, terms, conditions, and agreements of any and all duly authorized modifications of said Contract that may hereafter be made, notice of which modifications to the Surety being hereby waived, then, this obligation to be void; otherwise to remain in full force and virtue.

IN WITNESS WHEREOF, the above bounded parties have executed this instrument under the several seals on the date indicated above, the name and corporate seal of each corporate party being hereto affixed, and these presents duly signed by its undersigned representative, pursuant to authority of its governing body.

Executed in _____ counterparts.

Witness:

(Proprietorship of Partnership)

By:

Title:

(Corporate Secretary or
Assistant Secretary, Only)

CONTRACTOR:

(Trade or Corporate Name)

By:

Title:

(Owner, Partner, Corporate President or
Vice-President, Only)

(CORPORATE SEAL)

Witness:

Countersigned:

(N.C. Licensed Resident Agent)

SURETY COMPANY:

(Surety Company Name)

By:

Title:

(Attorney in Fact)

(SURETY CORPORATE SEAL)

PAYMENT BOND

Date of Execution: _____

Name of Principal: _____
(Contractor)

Name of Surety: _____

Name of Contracting

Body: Fayetteville Public Works Commission, Fayetteville, N.C.

Amount of Bond: _____

PROJECT: VARIOUS SEWER MANHOLE REHABILITATION (CIP) – FIBERGLASS REINFORCED EPOXY

KNOW ALL MEN BY THESE PRESENTS, that We, the PRINCIPAL and Surety above named, are held and firmly bound unto the above named Contracting Body, hereinafter called the Contracting Body, in the penal sum of the amount stated above the payment of which sum well and truly to be made, we bind ourselves, our heirs, executors, administrators, and successors, jointly and severally, firmly by these presents.

THE CONDITION OF THIS OBLIGATION IS SUCH that whereas the Principal entered into a certain Contract with the Contracting Body, identified as shown above and hereto attached.

NOW THEREFORE, if the Principal shall promptly make payment to all persons supplying labor and material in the prosecution of the work provided for in said contract, and any and all duly authorized modifications of said contract that may hereafter be made, notice of which modifications to the Surety being hereby waived, then, this obligation to be void; otherwise to remain in full force and virtue.

IN WITNESS WHEREOF, the above bounded parties have executed this instrument under the several seals on the date indicated above, the name and corporate seal of each corporate party being hereto affixed, and these presents duly signed by its undersigned representative, pursuant to authority of its governing body.

Executed in _____ counterparts.

Witness:

CONTRACTOR:

(Proprietorship of Partnership)

(Trade or Corporate Name)

By:

By:

Title:

Title:

(Corporate Secretary or
Assistant Secretary, Only)

(Owner, Partner, Corporate President or
Vice-President, Only)
(CORPORATE SEAL)

Witness:

SURETY COMPANY:

(Surety Company Name)

By:

Countersigned:

Title:

(N.C. Licensed Resident Agent)

(Attorney in Fact)
(SURETY CORPORATE SEAL)

**POWER OF ATTORNEY
(ATTACH)**

**CERTIFICATE(S) OF INSURANCE
(Attach)**

NOTICE TO PROCEED

TO: _____

Date: _____

PROJECT: VARIOUS SEWER MANHOLE REHABILITATION (CIP) – FIBERGLASS REINFORCED EPOXY

You are hereby notified to commence work in accordance with the Contract dated _____, 2023, on or before _____, 2023, and you are to complete the WORK within the **contract period** thereafter. The date of final completion therefore is _____.

FAYETTEVILLE PUBLIC WORKS COMMISSION

BY: _____

Candice S. Kirtz

Director of Supply Chain

ACCEPTANCE OF NOTICE

Receipt of the above NOTICE TO PROCEED

is hereby acknowledged this the _____ day of _____, 2023.

(CONTRACTOR)

BY: _____

TITLE: _____

- END OF SECTION -

VARIOUS SEWER MANHOLE REHABILITATION (CIP) – FIBERGLASS REINFORCED EPOXY

State of North Carolina
Cumberland County

CONSTRUCTION AGREEMENT

THIS CONSTRUCTION AGREEMENT (“Agreement” or “Contract”) is made by and between the Fayetteville Public Works Commission (“PWC”), a North Carolina public authority, and [REDACTED] (“Contractor”), a [REDACTED] registered to do business in North Carolina (each of each of PWC and Contractor is a “Party” and both are collectively the “Parties”) as of the date of execution last written below (the “Effective Date”). The Parties agree as follows:

1. The Construction Project. Contractor shall furnish and bear solely the entire cost of all labor and materials necessary for the construction and/or renovation of the Project (defined hereinbelow) as specified in the Contract Documents (defined hereinbelow) and complete all Work on the Project in a Workmanlike manner in strict accordance with the Contract Documents, schedule delivery of the new materials, furnish and bear solely the entire cost of all supervision, contract administration, equipment, tools, and other means necessary to complete the Project, perform every obligation imposed by the Contract Documents, and be solely responsible for the clean-up and disposal of all materials and debris relating to or arising from the construction and renovation, subject to any exceptions that are specifically set forth in the Contract Documents. Except as otherwise specifically provided in the Contract Documents, Contractor is solely responsible for all construction means, methods, techniques, sequences, procedures, safety precautions or programs, supervising, coordinating, and performing all the Work necessary to complete the Project; provided, however, PWC shall have the right, without incurring any liability to the Contractor, to suspend Contractor’s performance when a PWC employee, in his or her opinion, observes a safety violation involving a threat to life or imminent danger of bodily injury, and the suspension shall remain in effect until Contractor remedies the safety violation.

2. Terms. Capitalized terms used in this Agreement have the meaning specified below:

“Business Day” means each calendar day that is not a Saturday, Sunday, holiday observed by the federal government for its employees, or holiday observed by the State of North Carolina for its employees.

“Completion of the Project” means: (i) the Project is completed in accordance with this Agreement, except for punch list items; (ii) PWC has received any required temporary or final certificate of occupancy from the governmental agency with jurisdiction over the Project; and (iii) the registered architects or engineers (the “Designer(s)”) who designed portions or components of the Project have issued certificates of Completion of the Project as to those portions or components.

“Contract Documents” means the following documents that were either made available to Contractor by PWC during the bid solicitation process (including Drawings) or executed by the Parties or both, which are all incorporated by reference herein:

- a. This Agreement
- b. General Conditions

- c. Supplementary Conditions
- d. Bid Submittal Documents
- e. Contractor's Submitted Bid
- f. Bid Bond
- g. Notice of Award
- h. Acceptance of Award
- i. Performance Bond
- j. Payment Bond
- k. Copy of General Contractor's License
- l. Power of Attorney
- m. Certificate of Insurance
- n. Section C – Administrative Provisions
- o. Section D - Technical Specifications
- p. Section E- Details
- q. Appendices

The following documents may be delivered or issued on or after the Effective Date of the Agreement and may not be attached to this Agreement, but are considered Contract Documents when executed by the Parties:

- r. Notice to Proceed and Acceptance of Notice
- s. Work Change Directive(s)
- t. Change Order(s)
- u. Field Order(s)

There are no Contract Documents other than those identified in this Agreement. The Contract Documents may only be amended, modified, or supplemented as provided in this Agreement in a writing signed by the Parties.

"Fault" means a breach of contract by Contractor, negligent, reckless, or intentional act(s) or omission(s) constituting a tort under applicable statutes or common law by one or more Responsible Persons, or violation(s) of applicable statute(s) or regulation(s) by a Responsible Person.

"Project" means _____, as more specifically set forth in the Contract Documents.

"Responsible Person" means the Contractor and each of its employees, agents, representatives, subcontractors, or other persons and entities for which Contractor may be liable or responsible as a result of any statutory, tort, or contractual duty.

The terms used in this Agreement shall have the meaning as stated herein and in the General Conditions. In the event of a conflict between the terms of this Agreement and any other component(s) of the Contract Documents, the terms of this Agreement shall govern.

3. Contract Price. PWC shall pay Contractor for Completion of the Project in accordance with the Contract Documents the amount identified in the accepted Bid Form of Contractor, being in the total amount of \$ _____ (the "Price"). Contractor understands and acknowledges that the Price is derived from a specific

appropriation of funds provided for the Project. Contractor agrees and acknowledges the Price is equal to the aggregate cost of all Work to be done on the Project, including all labor, materials, equipment, apparatus, and supplies, set in accordance with the amount specified on the Bid Form submitted by Contractor and accepted by PWC.

4. Contract Times. The Parties shall perform their obligations under this Agreement in compliance with all scheduling deadlines set forth in the Contract Documents. The Contractor shall commence the Work to be performed under this Agreement on a date to be specified in accordance with the Notice to Proceed issued by PWC. Contractor shall achieve Completion of the Project no later than 360 consecutive calendar days from said date plus any modifications thereof allowed in accordance with the Contract Documents (the "Completion Date").

5. Payment. PWC shall pay Contractor in installment payments plus a final payment, as set forth in the Contract Documents. For each applicable installment payment, Contractor shall submit an application for payment in accordance with the Contract Documents. An application for payment will be processed by PWC as provided in the Contract Documents. Such installment payments shall reflect the actual Cost of the Work, not to exceed in total the Price, and the allocable portion of the total Price for said installment. PWC shall make payment to the Contractor, less any applicable retainage set forth in the Contract Documents; provided, however, that PWC may withhold all or a portion of a payment on account of (1) incomplete Work, (2) defective or nonconforming Work, (3) claims filed on a reasonable basis to believe that such claims will be filed imminently, (4) failure of the Contractor to make payments properly for labor, services, materials, equipment or subcontracts, (5) damages caused to PWC or another party by one or more Responsible Persons, or (6) failure to comply with the terms and conditions of this Agreement. In the final payment, PWC shall pay the balance of the Price, including all retained amounts, less any Liquidated Damages and other applicable damage and claim amounts, to Contractor within forty-five (45) days of Completion of the Project; provided, however, that PWC may withhold a reasonable sum from the final payment to ensure correction of any final items or condition on the Project.

6. Retainage. Subject to any restrictions applicable to any federal grant funds that may be utilized for the Project, PWC may, in its discretion, retain up to five percent (5%) of any periodic payment due Contractor; provided, however, when the Project is fifty percent (50%) complete, PWC, with written consent of the surety, shall not retain any further retainage from periodic payments due Contractor if Contractor continues to perform satisfactorily and any nonconforming Work identified in writing prior to that time by PWC or the Designer has been corrected by Contractor and accepted by PWC or the Designer, and provided further that full payment, less authorized deductions, shall also be made for those line item trades that have reached one hundred percent (100%) completion of their contract obligations by or before the Project is fifty percent (50%) complete if Contractor has performed satisfactorily in accordance with G.S. 143-134.1(b2), contingent upon PWC's receipt of an approval or certification from the Designer that the Work performed by the subcontractor is acceptable and in accordance with the Contract Documents. If PWC determines Contractor's performance is unsatisfactory, PWC may, in its discretion, reinstate retainage for each subsequent periodic application for payment as authorized in this Section up to the maximum amount of five percent (5%). The Project shall be deemed fifty percent (50%) complete when Contractor's gross project invoices, excluding the value of materials stored off-site, equal or exceed fifty percent (50%) of the Price, except the value of materials stored on-site shall not exceed twenty percent (20%) of Contractor's gross project invoices for the purpose of determining whether the Project is fifty percent (50%) complete. Within 60 days after the submission of a pay request and one of the following occurs, as specified in the Contract Documents, PWC, with written consent of the surety, shall release

to Contractor all retainage on payments held by PWC: (i) PWC receives a certificate of Substantial Completion from the Designer in charge of the Project; or (ii) PWC receives beneficial occupancy or use of the Project; provided, however, PWC may in its discretion retain sufficient funds to secure Completion of the Project or corrections on any Work. If PWC retains funds, the amount retained shall not exceed two and one-half times the estimated value of the Work to be completed or corrected. Any reduction in the amount of the retainage on payments shall be with the consent of Contractor's surety. The existence of any third-party claims against Contractor or any additive change orders to the Construction Documents shall not be a basis for delaying the release of any retainage on payments. Notwithstanding anything in this Section to the contrary, following fifty percent (50%) completion of the Project, PWC shall be authorized to withhold additional retainage from a subsequent periodic payment, not to exceed five percent (5%), in order to allow PWC to retain two and one-half percent (2.5%) total retainage through the Completion of the Project. In the event that PWC elects to withhold additional retainage on any periodic payment subsequent to release of retainage on a line-item of Work pursuant to G.S. 143-134.1(b2), Contractor may also withhold from the subcontractors remaining on the project sufficient retainage to offset the additional retainage held by PWC, notwithstanding the actual percentage of retainage withheld by PWC of the Project as a whole. Neither PWC's nor Contractor's release of retainage on payments as part of a payment in full on a line-item of Work pursuant to G.S. 143-134.1(b2) shall affect any applicable warranties on Work done by Contractor or subcontractor, and the warranties shall not begin to run any earlier than either PWC's receipt of a certificate of Substantial Completion from the Designer in charge of the Project or PWC receives beneficial occupancy.

7. Liquidated Damages. Time is of the essence with respect to performance of each of the Parties' obligations under this Agreement. Contractor recognizes and acknowledges that PWC will suffer financial and other losses if the Project is not completed by the Completion Date. The Parties recognize and agree that the delays, expense, and difficulties involved in proving in a legal or arbitration proceeding the actual loss suffered by PWC if the Project is not completed by the Completion Date. Accordingly, instead of requiring any such proof, Contractor and PWC agree that in the event Contractor fails to achieve Completion of the Project by the Completion Date, Contractor shall pay to PWC as liquidated damages to compensate PWC for damages related to the delayed Completion of the Project one thousand dollars (\$1000.00) per day ("Liquidated Damages") for each calendar day Contractor fails to achieve Completion of the Project by the Completion Date.

8. Contractor's Representations and Warranties. In order to induce PWC to enter into this Agreement, Contractor makes the following representations and warranties to PWC:

a. Contractor is duly licensed in the State of North Carolina to complete all Work necessary for the Project, is duly organized, validly existing and in good standing and has all requisite powers, rights, and authority to execute, enter into, and perform this Agreement in accordance with the terms and conditions of this Agreement, and this Agreement constitutes a legal, valid, and binding obligation of Contractor enforceable against it in accordance with its terms.

b. Contractor has read the Contract Documents, and acknowledges and understands all data, materials, specifications, and requirements identified in the Contract Documents.

c. Contractor has visited the site for the Project, conducted a thorough, visual examination of the site and adjacent areas, and become familiar

with and is satisfied as to the general, local, and site conditions that may affect cost, progress, and performance in completing the Project. Contractor is familiar with and is satisfied as to all laws and regulations that may affect cost, progress, and performance to complete the Project.

d. Contractor has carefully studied all: (1) reports of explorations and tests of subsurface conditions at or adjacent to the site and all drawings of physical conditions relating to existing surface or subsurface structures at the site that have been identified in the Contract Documents and any accompanying reports and drawings, and (2) reports and drawings relating to hazardous environmental conditions, if any, at or adjacent to the site that have been identified in the Contract Documents and any accompanying reports and drawings.

e. Contractor has considered the information known to Contractor itself; information commonly known to contractors doing business in the locality of the Site; information and observations obtained from visits to the Site; the Contract Documents; and the Site-related reports and drawings identified in the Contract Documents, if any, with respect to the effect of such information, observations, and documents on (1) the cost, progress, and performance of the Work; (2) the means, methods, techniques, sequences, and procedures of construction to be employed by Contractor; and (3) Contractor's safety precautions and programs.

f. Based on the information and observations referred to in subsection e. of this Section, Contractor agrees that no further examinations, investigations, explorations, tests, studies, or data are necessary for the performance of the Work at the Price commencing on the commencement date and in accordance with the other terms and conditions of the Contract.

g. Contractor is aware of the general nature of Work to be performed by PWC and others at the Site that relates to the Work as indicated in the Contract Documents.

h. Contractor has given PWC's Designer written notice of all conflicts, errors, ambiguities, or discrepancies that Contractor has discovered in the Contract Documents, and the written resolution thereof by the Designer is acceptable to Contractor.

i. The Contract Documents are generally sufficient to indicate and convey understanding of all terms and conditions for performance and furnishing of the Work.

j. Contractor's entry into this Agreement constitutes an incontrovertible representation by Contractor that, without exception, all prices in the Agreement are premised upon performing and furnishing the Work required by the Contract Documents.

k. Contractor has no business or personal relationship with any PWC Commissioner, officer, director, manager, or supervisor and Contractor covenants to disclose immediately to PWC any such relationship that develops during the performance of Work on the Project.

9. Contractor's Payment Obligations. Contractor shall pay all of its obligations arising out of or in connection with the Project in a timely manner to all persons supplying materials in the prosecution of the Work and to all laborers and others employed thereon.

10. Performance and Payment Bonds. Contractor shall obtain and deliver to PWC a performance bond in the amount of one hundred percent (100%) of the Price, conditioned upon the faithful performance of the Project and all Work in accordance with the Contract Documents, which bond shall be solely for the protection of PWC. Contractor shall obtain and deliver to PWC a payment bond in the amount of one hundred percent (100%) of the Price, conditioned upon the prompt payment for all labor or materials for which the Contractor or one or more of its subcontractors is liable, which payment bond shall be solely for the protection of the persons furnishing materials or performing labor for which the Contractor is liable. The performance bond and the payment bond shall be executed by one or more surety companies legally authorized to do business in the State of North Carolina, shall become effective upon the awarding of the construction contract by PWC to Contractor, and shall at all times comply with the requirements set forth in Article 3 of North Carolina General Statutes Chapter 44A. In the event PWC deems the surety or sureties upon any bond necessary for this Agreement and the completion of the Project, or if for any reason, such bond ceases to be adequate to cover the performance and/or payment of the Work, Contractor shall, at its expense, within five (5) days after the receipt of notice from PWC, furnish an additional bond or bonds in such form and amount, and with such surety or sureties as shall be satisfactory to PWC. In such event no further payment to Contractor shall be deemed to be due under this Agreement until new or additional security for the performance and payment of the Project shall be furnished in manner and form satisfactory to PWC. Contractor understands and acknowledges that PWC, as a public authority, is not subject to the provisions of Articles 1 and 2 of Chapter 44A of the General Statutes, in accordance with G.S. 44A-34 and applicable law.

11. Contractor's Damage Repair Obligations. Contractor shall be responsible for all damages to the property of the City of Fayetteville and of PWC that may result from the normal procedure of a Responsible Person's actions in the prosecution of the Work or that may be caused by or result from the negligence of a Responsible Person during the progress of or connected with the prosecution of the Work, whether within the limits of the Work or elsewhere. Contractor shall promptly restore all such property so damaged to a condition as good as it was immediately prior to Contractor initiating the Work on the Project.

12. Defective Work. The Project shall be subject to observation and approval by PWC, Designer, and representatives of governmental agencies with jurisdiction over the Project. PWC and Designer shall be entitled to enter at all reasonable times the premises subject to construction or renovation to inspect the Work performed by or on behalf of Contractor, provided that such entry and inspection does not materially interfere with the progress of construction. Contractor shall correct promptly, at no cost to PWC, all Work reasonably rejected by PWC or by its representatives. Should Contractor fail to correct rejected Work, PWC may, acting in its sole discretion, correct such Work and the Contractor shall pay PWC's actual costs of correction and any other applicable amounts identified in the Contract Documents.

13. As-Built Drawings. Contractor shall maintain during the progress of the Project as-built drawings indicating the current status of the Project as actually performed. Upon Completion of the Project, Contractor shall prepare a final version of such as-built drawings and submit them to PWC for approval.

14. Assignment. This Agreement shall be binding upon and inure to the benefit of the Parties, their legal representatives, successors, and assigns. Contractor may not assign, transfer, convey, or encumber, whether voluntarily or by operation of law, this Agreement or any obligations, rights under, or interests in this Agreement to a third party without the prior written consent of PWC; and, specifically, but without limitation, money that may become due and money that is due may not be assigned without such consent (except to the extent that the effect of this restriction may be limited by law), and unless specifically stated to the contrary in any written consent to an assignment, no assignment will release or discharge the assignor from any duty or responsibility under the Contract Documents.

15. Indemnity. Contractor shall indemnify, defend, and hold harmless PWC and its Commissioners, officers, employees, agents, and representatives and the City of Fayetteville and its elected officials, managers, employees, agents, and representatives and Design Engineer (collectively "Indemnitees") from and against all claims, actions, liabilities, damages, losses, costs, and expenses (including, without limitation, injury to or death of any persons and damage to property, economic and consequential damages and attorneys' fees) asserted by one or more third parties against one or more of the Indemnitees if the Fault of one or more Responsible Persons is a proximate cause of the loss, damage, or expense indemnified. Contractor's obligation to indemnify, defend, and hold harmless the Indemnitees shall survive the termination of this Agreement.

16. Insurance. Contractor shall maintain during the Work and for at least three (3) years following Completion of the Project the insurance coverage set forth in the Contract Documents, which insurance shall be placed with insurance companies authorized to do business in the State of North Carolina and rated A minus VII or better by the current edition of Best's Key Rating Guide or otherwise approved in writing by PWC. Prior to initiating any Work, Contractor shall deliver certificates of insurance confirming each such coverage required by the Contract Documents, and Contractor shall direct its insurers to provide annually to PWC certificates confirming each such coverage during the coverage period. PWC shall be named as an additional insured in the comprehensive automobile and commercial liability insurance policies. Commercial general liability coverage shall be written on an "occurrence" basis. Contractor shall not reduce or allow the required insurance coverages to lapse without PWC's prior written approval. All policies for insurance must be endorsed to contain a provision giving PWC a thirty (30) calendar day prior written notice by certified mail of any cancellation of that policy or material reduction in coverage. Should a notice of cancellation be issued for non-payment of premiums or any part thereof, or should Contractor fail to provide and maintain certificates as set forth herein, PWC shall have the right, but shall not have the obligation, to pay such premium to the insurance company or to obtain such coverage and to deduct such payment from any sums that may be due or become due to Contractor, or to seek reimbursement for said payments from Contractor. Any such sums paid by PWC shall be due and payable immediately by Contractor upon notice from PWC. The insurance provisions of this Agreement shall not be construed as a limitation on Contractor's responsibilities and liabilities pursuant to the terms and conditions of this Agreement. Contractor's obligation to maintain insurance for three (3) years after Completion of the Project shall survive the termination of this Agreement.

17. Warranty. The Contractor hereby grants to PWC a warranty on all materials and Workmanship involved in the Project for a period of one (1) year from the Completion Date and a period of two (2) years from the Completion Date for any latent structural defects. PWC shall give written notice to Contractor of any claim under this Section within the time specified hereinabove. This warranty shall be in addition to, and not in derogation of, all other rights and

privileges which PWC may have under law, equity, or instrument, and shall survive the Completion Date and the final settlement and shall be binding on Contractor notwithstanding any provision in any other writing executed by PWC heretofore or contemporaneous with the execution of the Agreement or prior to the Completion Date.

18. Waiver. No failure on the part of any party to exercise, and no delay in exercising, any right, power, or privilege hereunder shall operate as a waiver thereof, nor shall any single or partial exercise of any right hereunder preclude any other or further cumulative and not exclusive of any remedies provided by law. This Agreement shall be binding upon and inure to the benefit of the parties, their legal representatives, successors, and assigns. This Agreement may not be assigned, transferred, conveyed, or encumbered, whether voluntarily or by operation of law, by either party without the prior written consent of the other party, which consent shall not be unreasonably withheld.

19. Law. THIS AGREEMENT SHALL BE GOVERNED BY AND INTERPRETED AND ENFORCED IN ACCORDANCE WITH THE LAWS OF THE STATE OF NORTH CAROLINA WITHOUT GIVING EFFECT TO THE CHOICE OF LAW PROVISIONS THEREOF. The Contractor shall at all times comply with all applicable Federal, state, and local laws and building codes in the performance of its obligations under the Agreement.

20. Dispute Resolution. In the event of any dispute, controversy, or claim of any kind or nature arising under or in connection with this Agreement (a "Dispute") and involving any two or more of the following parties, PWC, Designer, Contractor or any subcontractor of Contractor, the party initiating the Dispute shall serve written notice of a Dispute on the party(ies) to the dispute, and those parties shall endeavor to settle the dispute first through direct, informal discussions between the parties' selected representatives. Any such representative(s) shall have binding authority to settle the Dispute. In the event the parties do not settle the Dispute within ten (10) days from the date of written notice of the Dispute, any party to the Dispute may, by written notice to the other party(ies), engage a mediator certified under the laws of the State of North Carolina to mediate the Dispute within thirty (30) days of such notice. The parties to the Dispute shall attend mediation in good faith. In the event mediation is unsuccessful, any party to the dispute may initiate arbitration proceedings. Any controversy or claim arising out of or relating to the Contract Documents, or the breach thereof, shall be settled by binding arbitration administered by the American Arbitration Association under its Construction Industry Arbitration Rules, and judgment on the award rendered by the arbitrator(s) may be entered in any court having jurisdiction thereof. All of the foregoing dispute resolution procedures shall be held in Cumberland County, North Carolina. The costs of the mediator and arbitrator in a dispute resolution process shall be divided equally among the parties to the process; provided, however, PWC shall bear at least one-third of the cost if PWC is a party to the dispute resolution and the remainder of the cost shall be divided equally among the other parties participating in the dispute resolution. PWC shall, in its contractual arrangements with Designer, and Contractor shall, in its contracts with subcontractors and they in their contracts with lower-tier subcontractors authorize and direct such parties to participate in the dispute resolution procedures set forth in this Section. Unless otherwise directed in writing by PWC, Contractor shall continue the Project and maintain compliance with the scheduling deadlines set forth in the Contract Documents during any dispute resolution proceedings. If Contractor continues to perform, PWC shall make payments due for the continued performance in accordance with this Agreement. The provisions of this Section shall not extend any applicable statutes of limitation or repose.

21. Execution; Modification; Entire Agreement; Severability. This Agreement may be

executed in counterparts with the same effect as if the signatures to each counterpart were upon a single instrument, and all such counterparts together shall be deemed an original of this Agreement. For purposes of this Agreement, a facsimile copy or scanned copy or photocopy of a party's signature shall be sufficient to bind such party. This Agreement shall be subject to execution by electronic means in accordance with Article 40 of Chapter 66 of the North Carolina General Statutes. No oral communication, promise, understanding, or agreement before, contemporaneous with, or after the execution of this Agreement shall affect or modify any of the terms and conditions and obligations of the Contract Documents. The Contract Documents shall be modified only by a subsequent writing signed by both Parties. The Contract Documents shall be conclusively considered to contain and express all the terms and conditions agreed upon by the Parties, notwithstanding any prior or contemporaneous written communication, promise, understanding or agreement. Should any provision of this Agreement or any of the Contract Documents at any time be in conflict with any law, statute, rule, regulation, order, or ruling and thus be unenforceable, or be unenforceable for any other reason, then the remaining provisions of this Agreement shall remain in full force and effect and the court or arbitrator shall give the offending provision the fullest meaning and effect permitted by law. The titles of the Sections throughout this Agreement are for convenience only and the words contained therein shall in no way be held to explain, modify, amplify or aid in the interpretation, construction, or meaning of the provisions of this instrument.

22. Notices. Any notice which either Party is required or desires to give the other hereunder shall be deemed sufficiently given if, in writing, it is delivered personally, or sent by certified U.S. mail, return-receipt requested, postage prepaid, to the addresses listed herein below, or such other address as either Party shall give to the other Party by written notice in accordance herewith. Any notice given herein by personal delivery shall be deemed delivered when received. Any properly addressed notice given herein by certified mail shall be deemed delivered on third Business Day after the same is deposited in an official United States Post Office, postage prepaid, or if sooner upon the date when the return receipt therefore is signed, or refusal to accept the mailing by the addressee is noted thereon by the postal authorities.

To PWC:
Fayetteville Public Works Commission
Attn: Marion J. Noland, Interim CEO/General Manager PO Box 1089
Fayetteville, NC 28302

To Contractor:

23. Termination. PWC may terminate this Agreement immediately if during the progress of the Work or during the warranty period, the Contractor:

- a. Persistently fails to prosecute the Work properly and in accordance with this contract, including but not limited to include failure to provide sufficient crews, equipment, or resources, or failure to adhere to the schedule;
- b. Demonstrates disregard for the policies, procedures, or requirements of PWC;
- c. Demonstrates complete disregard of the authority of PWC or its

designated representatives; or

- d. Violates in any substantial way the provisions and requirements of this Agreement.

Such termination shall be effective upon written notice to Contractor and its surety. PWC may terminate the contract for its convenience by providing Contractor at least seven (7) calendar days prior written notice, in which event Contractor shall be paid for all Work completed, plus other expenses as mutually agreed upon between PWC and Contractor.

24. Compliance. Contractor hereby acknowledges that “E-Verify” is the federal E-Verify program operated by the US Department of Homeland Security and other federal agencies which is used to verify the Work authorization of newly hired employees pursuant to federal law and in accordance with Article 2, Chapter 64 of the North Carolina General Statutes. Contractor further acknowledges that all employers, as defined by Article 2, Chapter 64 of the North Carolina General Statutes, must use E-Verify and after hiring an employee to Work in the United States, shall verify the Work authorization of the employee through E-Verify in accordance with N.C.G.S. §64-26(a). Contractor hereby pledges, attests, and warrants through execution of this Agreement that Contractor complies with the requirements of Article 2, Chapter 64 of the North Carolina General Statutes and further pledges, attests, and warrants that all subcontractors currently employed by or subsequently hired by Contractor shall comply with all E-Verify requirements. Failure to comply with the above requirements shall be considered a breach of this Agreement. Contractor hereby further acknowledges that the execution and delivery of this Agreement constitutes Contractor’s certification to PWC and to the North Carolina State Treasurer that, as of the date of the Effective Date of this Agreement, Contractor is not listed on (a) the Final Divestment List created and maintained by the North Carolina Department of State Treasurer pursuant to the Iran Divestment Act of 2015, Chapter 147, Article 6E of the General Statutes of North Carolina (the “Iran Divestment Act”); or (b) the list of companies that the North Carolina State Treasurer determines to be engaged in a boycott of Israel in accordance with Article 6G of Chapter 147 of the General Statutes of North Carolina. Contractor represents and warrants to Commission that Contractor, and all persons and entities owning (directly or indirectly) an ownership interest in it: (i) are not, and will not become, a person or entity with whom a party is restricted from doing business with under regulations of the Office of Foreign Asset Control (“OFAC”) of the Department of the Treasury (including, but not limited to, those named on OFAC’s Specially Designated and Blocked Persons list) or under any statute, executive order (including, but not limited to, the September 24, 2001, Executive Order 13224 Blocking Property and Prohibiting Transactions with Persons Who Commit, Threaten to Commit, or Support Terrorism), or other governmental action; and (ii) are not knowingly engaged in, and will not knowingly engage in, any dealings or transactions or be otherwise associated with such persons or entities described in clause (i) above. Contractor also shall at all times during the term of this Agreement comply with Executive Order 11246, including but not limited to the Equal Opportunity Clause requirements set forth in 41 C.F.R. § 60-1.4. Contractor shall abide by the requirements of 41 CFR 60–300.5(a) and 60–741.5(a) prohibiting discrimination against qualified individuals on the basis of protected veteran status or disability and requiring affirmative action by covered prime contractors and subcontractors to employ and advance in employment qualified protected veterans and individuals with disabilities.

IN WITNESS WHEREOF, the Parties have executed this Agreement by their duly authorized representatives.

Fayetteville Public Works Commission

CONTRACTOR

By: _____
Marion J. Noland, Interim CEO/GM

By: _____

(Printed Name, Title)

Date: _____

Date: _____

This instrument has been preaudited in the manner required by the Local Government Budget and Fiscal Control Act (N.C. Gen. Stat. § 159-1 et seq.).

By: _____
Rhonda Haskins, Chief Financial Officer

Approved as to form:

Legal Dept.

SAMPLE



GENERAL CONDITIONS FOR
FAYETTEVILLE PUBLIC WORKS COMMISSION

General Conditions	5
Article I. Definitions and Terminology	5
Section 1.01 Definitions.....	5
Section 1.02 Terminology.....	9
Article II. Preliminary Matters	10
Section 2.01 Delivery of Bonds and Evidence of Insurance.....	10
Section 2.02 Copies of Documents.....	10
Section 2.03 Before Starting any Work.....	10
Section 2.04 Preconstruction Conference; Designation of Authorized Representatives.....	10
Section 2.05 Initial Acceptance of Schedules.....	11
Section 2.06 Electronic Transmittals.....	11
Article III. Contract Documents: Intent, Requirements, Reuse	12
Section 3.01 Intent.....	12
Section 3.02 Reference Standards.....	12
Section 3.03 Reporting and Resolving Discrepancies.....	12
Section 3.04 Reuse of Documents.....	13
Article IV. Commencement and Progress of the Work	13
Section 4.01 Commencement of Work.....	13
Section 4.02 Reference Points.....	14
Section 4.03 Progress Schedule.....	14
Section 4.04 Delays in Contractor’s Progress.....	14
Article V. Availability of Lands; Subsurface and Physical Conditions; Hazardous Environmental Conditions	15
Section 5.01 Availability of Lands.....	15
Section 5.02 Use of Site and Other Areas.....	15
Section 5.03 Differing Subsurface or Physical Conditions or Underground Facilities.....	16
Section 5.04 Underground Utilities.....	17
Section 5.05 Hazardous Environmental Conditions at Site.....	19
Article VI. Bonds and Insurance	20
Section 6.01 Performance and Payment Bonds.....	20
Section 6.02 Insurance.....	20
Article VII. Contractor’s Responsibilities	22
Section 7.01 Supervision and Superintendence.....	22
Section 7.02 Labor; Working Hours.....	23
Section 7.03 Services, Materials, and Equipment.....	23
Section 7.04 “Or Equals”.....	23
Section 7.05 Concerning Subcontractors, Suppliers, and Others.....	24
Section 7.06 Patent Fees and Royalties.....	25

General Conditions (Rev 7/2023)

Section 7.07	Permits	25
Section 7.08	Taxes	26
Section 7.09	Laws and Regulations	26
Section 7.10	Record Documents	26
Section 7.11	Safety and Protection	26
Section 7.12	Emergencies.....	27
Section 7.13	Shop Drawings, Samples, and Other Submittals	27
Section 7.14	Contractor's General Warranty and Guarantee.....	29
Section 7.15	Indemnification	30
Section 7.16	Claims Procedure	31
Section 7.17	Delegation of Professional Design Services	31
Article VIII.	PWC's Responsibilities	32
Article IX.	Amending the Contract Documents; Changes in the Work.....	32
Section 9.01	Amending and Supplementing Contract Documents.....	33
Section 9.02	PWC-Authorized Changes in the Work.....	33
Section 9.03	Unauthorized Changes in the Work	33
Section 9.04	Change of Contract Price.....	34
Section 9.05	Change of Contract Times	34
Section 9.06	Change Proposals	34
Section 9.07	Execution of Change Orders.....	35
Section 9.08	Notification to Surety.....	35
Article X.	Tests, Inspections, and Approvals; Correction, Removal, or Acceptance of Defective Work.....	35
Section 10.01	Access to Work	35
Section 10.02	Tests, Inspections, and Approvals.....	36
Section 10.03	Defective Work.....	36
Section 10.04	Acceptance of Defective Work	37
Section 10.05	Uncovering Work.....	37
Section 10.06	PWC May Stop the Work	38
Section 10.07	PWC May Correct Defective Work	38
Article XI.	Claims.....	39
Section 11.01	Claims Process	39
Section 11.02	Submittal of Claim	39
Section 11.03	Review and Resolution.....	39
Section 11.04	Dispute Resolution.....	39
Article XII.	Payments to Contractor; Set-Offs; Completion; Correction Period.....	40
Section 12.01	Progress Payments.....	40
Section 12.02	Substantial Completion	43

General Conditions (Rev 7/2023)

Section 12.03	Partial Use or Occupancy	44
Section 12.04	Final Inspection	44
Section 12.05	Final Payment	44
Section 12.06	Waiver of Claims	45
Section 12.07	Correction Period	45
Article XIII.	Suspension of Work and Termination	46
Section 13.01	PWC May Suspend Work	46
Section 13.02	PWC May Terminate for Cause	46
Section 13.03	PWC May Terminate For Convenience	47
Section 13.04	Contractor May Stop Work or Terminate	48
Section 13.05	Morality	48
Article XIV.	Miscellaneous	48
Section 14.01	Additional General Terms and Conditions	48
Section 14.02	Giving Notice	48
Section 14.03	Computation of Times	49
Section 14.04	Cumulative Remedies	49
Section 14.05	Limitation of Damages	49
Section 14.06	No Waiver	49
Section 14.07	Survival of Obligations	49
Section 14.08	Controlling Law	49
Section 14.09	Headings	49

General Conditions

Article I. Definitions and Terminology

Section 1.01 Definitions

Capitalized terms used in the Bid Documents or Contract Documents, including the singular and plural forms, shall have the meaning indicated in the definitions below. In addition to terms specifically defined below, terms with initial capital letters in the Contract Documents include references to identified articles and paragraphs, and the titles of other documents or forms.

- (a) **Addenda**—Written or graphic instruments issued before the opening of Bids which clarify, correct, or change the Bid Documents or other Contract Documents.
- (b) **Agreement**—The written instrument, executed by PWC and Contractor, that sets forth the Contract Price and Contract Times, identifies the parties, designates the specific documents that encompass the Contract Documents, and provides other material provisions that govern the relationship between the parties as it relates to the Project. The Agreement is also referred to, and titled as, the “Construction Agreement.”
- (c) **Application for Payment**—The form that Contractor shall use during the Work in requesting progress or final payments. Any Application for Payment shall be accompanied by such supporting documentation as is required by the Contract Documents.
- (d) **Bid**—The offer of a Bidder submitted on the prescribed form setting forth the prices for the Work to be performed.
- (e) **Bidder**—An individual or entity that submits a Bid to PWC for the Project.
- (f) **Bid Documents**—The Bidding Requirements, the proposed Contract Documents, and all Addenda.
- (g) **Bidding Requirements**—The Invitation to Bid, Instructions to Bidders, Bid Bond or other Bid security, if any, the Bid Form, and the Bidder’s original Bid with any requisite attachments.
- (h) **Business Day**—each calendar day that is not a Saturday, Sunday, or holiday observed by PWC (New Year’s Day, Martin Luther King, Jr. Day, Good Friday, Memorial Day, Independence Day, Labor Day, Veteran’s Day, Thanksgiving Day (and the day after), and Christmas (2 days) for its employees.
- (i) **Change Order**—A document that is signed by Contractor and PWC, which authorizes an addition, deletion, or revision in the Work, an adjustment in the Contract Price or the Contract Times, a change in the scope of the Project, or other revision to the Agreement, issued on or after the Effective Date of the Agreement.
- (j) **Change Proposal**—A written request by Contractor, submitted in compliance with the procedural requirements set forth in the Contract Documents, seeking an adjustment in Contract Price or Contract Times, or both; contesting an initial decision by PWC concerning the requirements of the Contract Documents or the acceptability of Work under the Contract Documents; challenging a set-off against payments due; or seeking other relief with respect to the terms of the Agreement.

- (k) Completion of the Project—Has the meaning as set forth in the Construction Agreement.
- (l) Constituent of Concern—Asbestos, petroleum, radioactive materials, polychlorinated biphenyls (PCBs), hazardous waste, and any substance, product, waste, or other material of any nature whatsoever that is or becomes listed, regulated, or addressed pursuant to (a) the Comprehensive Environmental Response, Compensation and Liability Act, 42 U.S.C. §§9601 et seq. (“CERCLA”); (b) the Hazardous Materials Transportation Act, 49 U.S.C. §§5101 et seq.; (c) the Resource Conservation and Recovery Act, 42 U.S.C. §§6901 et seq. (“RCRA”); (d) the Toxic Substances Control Act, 15 U.S.C. §§2601 et seq.; (e) the Clean Water Act, 33 U.S.C. §§1251 et seq.; (f) the Clean Air Act, 42 U.S.C. §§7401 et seq.; or (g) any other federal, state, or local statute, law, rule, regulation, ordinance, resolution, code, order, or decree regulating, relating to, or imposing liability or standards of conduct concerning, any hazardous, toxic, or dangerous waste, substance, or material.
- (m) Contract Price—The money that PWC has agreed to pay Contractor for Completion of the Project in accordance with the Contract Documents. May also be referred to as “Price” throughout the Contract Documents.
- (n) Contract Times—The number of days or the dates by which Contractor shall: (a) achieve Milestones, if any; and (b) Completion of the Project.
- (o) Contractor—The individual or entity with which PWC has contracted for performance of the Work and Completion of the Project.
- (p) Day—a calendar day of 24 hours measured from midnight to the next midnight. Also referred to throughout the Contract Documents as “days” or “calendar days.”
- (q) Design Engineer—The Engineering firm identified on the Contract Drawings and their duly authorized employees and agents, such employees and agents acting within the scope of the particular duties entrusted to them in each case.
- (r) Drawings—The part of the Contract that graphically shows the scope, extent, and character of the Work to be performed by Contractor.
- (s) Field Order—A written order issued by Project Engineer which requires minor changes in the Work but does not change the Contract Price or the Contract Times.
- (t) Final Completion—The day the on which any specified Work is complete in accordance with the Contract Documents.
- (u) Hazardous Environmental Condition—The presence at the Site of Constituents of Concern in such quantities or circumstances that may present a danger to persons or property exposed thereto. The presence at the Site of materials that are necessary for the execution of the Work, or that are to be incorporated in the Work, and that are controlled and contained pursuant to industry practices, Laws and Regulations, and the requirements of the Contract Documents, does not establish a Hazardous Environmental Condition.
- (v) Laws and Regulations; Laws or Regulations—Any and all applicable laws, statutes, rules,

General Conditions (Rev 7/2023)

regulations, ordinances, codes, and orders of any and all governmental bodies, agencies, authorities, and courts having jurisdiction. Such terms, unless otherwise specified, shall refer to North Carolina laws and regulations.

- (w) Milestone—A principal event in the performance of the Work that the Agreement requires Contractor to achieve by an intermediate completion date or by a time prior to Completion of the Project.
- (x) Non-Compliance Notice—A written notice issued by PWC to Contractor indicating a violation of any term, provision, or requirement of the Contract Documents.
- (y) Notice of Award—The written notice by PWC to a Bidder providing of PWC's acceptance of the Bid upon timely compliance by the Bidder with any conditions precedent provided in the notice.
- (z) Notice to Proceed—A written notice by PWC to Contractor fixing the date on which the Contract Times will commence to run and on which Contractor shall start to perform the Work.
- (aa) Progress Schedule—A schedule, prepared and maintained by Contractor, describing the sequence and duration of the activities comprising the Contractor's plan to accomplish the Work within the Contract Times.
- (bb) Project—has the meaning ascribed to it in the Agreement and is as more specifically set forth throughout the Contract Documents. "Project" includes the total undertaking to be accomplished for PWC by engineers, contractors, and others, including planning, study, design, construction, testing, commissioning, and start-up, and of which the Work to be performed under the Contract Documents is a part.
- (cc) Project Engineer—the PWC employee assigned by PWC to coordinate, manage, monitor, and otherwise perform the administration necessary and consistent with PWC's responsibilities for the Completion of the Project. The Project Engineer has authority to coordinate and work with the Design Engineer regarding any engineering questions, concerns, revisions, alterations, deletions, or additions to the Work, and has authority to approve any changes in the scope of the Work. Project Engineer may assign a "Project Coordinator" who will also be an employee of PWC and have the duties and responsibilities set by the Project Engineer.
- (dd) PWC—Fayetteville Public Works Commission. PWC may also be referred to in the Contract Documents as "Owner."
- (ee) Samples—Physical examples of materials, equipment, or workmanship that are representative of some portion of the Work and that establish the standards by which such portion of the Work will be judged.
- (ff) Schedule of Submittals—A schedule, prepared and maintained by Contractor, of required submittals and the time requirements for Project Engineer's review of the submittals and the performance of related construction activities.
- (gg) Schedule of Values—A schedule, prepared and maintained by Contractor, allocating portions of the Contract Price to various portions of the Work and used as the basis for reviewing Contractor's Applications for Payment.

General Conditions (Rev 7/2023)

- (hh) Shop Drawings—All drawings, diagrams, illustrations, schedules, and other data or information that are specifically prepared or assembled by or for Contractor and submitted by Contractor to illustrate some portion of the Work. Shop Drawings, whether approved or not, are not Contract Drawings and are not Contract Documents.
- (ii) Site—Lands or areas indicated in the Contract Documents as being furnished by PWC upon which the Work is to be performed, including rights-of-way and easements, and such other lands furnished by PWC which are designated for the use of Contractor.
- (jj) Specifications—The part of the Contract that consists of written requirements for materials, equipment, systems, standards, and workmanship as applied to the Work, and certain administrative requirements and procedural matters applicable to the Work.
- (kk) Subcontractor—An individual or entity having a direct contract with Contractor or with any other Subcontractor for the performance of a part of the Work.
- (ll) Substantial Completion—The time at which the Work (or a specified part thereof) has progressed to the point where, in the opinion of Project Engineer, the Work (or a specified part thereof) is sufficiently complete, in accordance with the Contract Documents, so that the Work (or a specified part thereof) can be utilized for the purposes for which it is intended. The terms “substantially complete” and “substantially completed” as applied to all or part of the Work refer to Substantial Completion thereof.
- (mm) Successful Bidder—The Bidder whose Bid PWC accepts, and to which PWC provides a Notice of Award.
- (nn) Supplementary Conditions—Any part of the Agreement that amends or supplements these General Conditions.
- (oo) Supplier—A manufacturer, fabricator, supplier, distributor, materialman, or vendor having a direct contract with Contractor or with any Subcontractor to furnish materials or equipment to be incorporated in the Work by Contractor or a Subcontractor.
- (pp) Technical Data—Those items expressly identified as Technical Data in the Supplementary Conditions, with respect to either (a) subsurface conditions at the Site, or physical conditions relating to existing surface or subsurface structures at the Site (except Underground Facilities) or (b) Hazardous Environmental Conditions at the Site. If no such express identifications of Technical Data have been made with respect to conditions at the Site, then the data contained in boring logs, recorded measurements of subsurface water levels, laboratory test results, and other factual, objective information regarding conditions at the Site that are set forth in any geotechnical or environmental report prepared for the Project and made available to Contractor are hereby defined as Technical Data with respect to conditions at the Site under Paragraphs 5.03, 5.04, and 5.06.
- (qq) Underground Facilities—All underground pipelines, conduits, ducts, cables, wires, manholes, vaults, tanks, tunnels, or other such facilities or attachments, and any encasements containing such facilities, including but not limited to those that convey electricity, gases, steam, liquid petroleum products, telephone or other communications, fiber optic transmissions, cable television, water, wastewater, storm water, other liquids or chemicals, or traffic or other control systems.

General Conditions (Rev 7/2023)

- (rr) Unit Price Work—Work to be paid for on the basis of unit prices.
- (ss) Work—The entire construction or the various separately identifiable parts thereof required to be provided under the Contract Documents. Work includes and is the result of performing or providing all labor, services, materials, equipment, and documentation necessary to produce such construction; furnishing, installing, and incorporating all materials and equipment into such construction; and may include related services such as testing, start-up, and commissioning, all as required by the Contract Documents and necessary to achieve Completion of the Project.
- (tt) Work Change Directive—A written directive to Contractor issued on or after the Effective Date of the Contract, signed by PWC and recommended by the Project Engineer, ordering an addition, deletion, or revision in the Work.

Section 1.02 Terminology

The words and terms discussed in the following paragraphs are not defined but, when used in the Bidding Requirements or Contract Documents, have the indicated meaning.

- (a) Intent of Certain Terms or Adjectives:
 - (i) The Contract Documents include the terms “as allowed,” “as approved,” “as ordered,” “as directed” or terms of like effect or import to authorize an exercise of professional judgment by Project Engineer. In addition, the adjectives “reasonable,” “suitable,” “acceptable,” “proper,” “satisfactory,” or adjectives of like effect or import are used to describe an action or determination of Project Engineer as to the Work. It is intended that such exercise of professional judgment, action, or determination will be solely to evaluate, in general, the Work for compliance with the information in the Contract Documents and with the design concept of the Project as a functioning whole as shown or indicated in the Contract Documents (unless there is a specific statement indicating otherwise). The use of any such term or adjective is not intended to and shall not be effective to assign to Project Engineer any duty or authority to supervise or direct the performance of the Work, or any duty or authority to undertake responsibility contrary to the provisions the Contract Documents.
- (b) Defective—when modifying the word “Work,” refers to Work that is unsatisfactory, faulty, or deficient in that it:
 - (i) does not conform to the Contract Documents; or
 - (ii) does not meet the requirements of any applicable inspection, reference standard, test, or approval referred to in the Contract Documents; or
 - (iii) has been damaged prior to Project Engineer’s recommendation of final payment (unless responsibility for the protection thereof has been assumed by PWC at Substantial Completion in accordance with the Contract Documents).
- (c) Furnish, Install, Perform, Provide
 - (i) The word “furnish,” when used in connection with services, materials, or equipment, shall mean to supply and deliver said services, materials, or equipment to the Site (or some other specified location) ready for use or installation and in usable or operable condition.
 - (ii) The word “install,” when used in connection with services, materials, or equipment, shall mean to put into use or place in final position said services, materials, or equipment

General Conditions (Rev 7/2023)

- complete and ready for intended use.
- (iii) The words “perform” or “provide,” when used in connection with services, materials, or equipment, shall mean to furnish and install said services, materials, or equipment complete and ready for intended use.
- (iv) If the Contract Documents establish an obligation of Contractor with respect to specific services, materials, or equipment, but do not expressly use any of the four words “furnish,” “install,” “perform,” or “provide,” then Contractor shall furnish and install said services, materials, or equipment complete and ready for intended use.

Unless stated otherwise in the Contract Documents, words or phrases that have a well-known technical or construction industry or trade meaning are used in the Contract Documents in accordance with such recognized meaning.

Article II. Preliminary Matters

Section 2.01 Delivery of Bonds and Evidence of Insurance

- (a) Bonds: Contractor shall deliver to PWC such bonds as Contractor is required to furnish simultaneously with delivering the executed Agreement to PWC.
- (b) Contractor’s Insurance: Contractor shall deliver to PWC the certificates and other evidence of the insurance required by the Contract Documents simultaneously with delivering the executed Agreement to PWC.

Section 2.02 Copies of Documents

- (a) PWC will furnish to Contractor up to five (5) printed copies of the Contract Documents upon request by Contractor, and one (1) copy in electronic portable document format (PDF). Additional printed copies will be furnished upon request at the cost of reproduction.
- (b) PWC will maintain and safeguard at least one original printed record version of the Agreement, including Drawings and Specifications signed and sealed by Design Engineer or other design professionals as applicable. PWC agrees to make such original printed record version of the Agreement reasonably available to Contractor for review during PWC’s normal business hours. PWC may delegate the responsibilities under this provision to Design Engineer.

Section 2.03 Before Starting any Work

- (a) Within ten (10) Days after the Contractor receives the Notice of Award from PWC (or as otherwise specifically required by the Contract Documents), Contractor shall submit to PWC for timely review:
 - (i) a preliminary Progress Schedule indicating the times (numbers of days or dates) for starting and completing the identifiable aspects of the Work, including any Milestones specified in the Contract Documents;
 - (ii) a preliminary Schedule of Submittals; and
 - (iii) Any Shop Drawings, Samples, and other submittals required by the Contract Documents before the Preconstruction Conference.

Section 2.04 Preconstruction Conference; Designation of Authorized Representatives

- (a) Before any Work at the Site is started, a preconstruction conference attended by PWC, Project Engineer, Contractor, Design Engineer, and others as appropriate will be held to establish a working understanding among the parties as to the Work and to discuss general Project issues including, but not limited, the following:
 - (i) The schedules and submittals referred to in Section 2.03;
 - (ii) Contractor's designated authorized representative as described in Section 2.04(b);
 - (iii) Safety;
 - (iv) Procedures for handling Shop Drawings, Samples, and other submittals;
 - (v) Processing Applications for Payment, electronic or digital transmittals;
- (b) At the preconstruction conference Contractor shall designate, in writing, a specific individual to act as its authorized representative with respect to its services and responsibilities under the Contract Documents. Such individual shall have the authority to transmit and receive information, render decisions relative to the requirements of the Contract Documents, and otherwise act on behalf of the Contractor.

Section 2.05 Initial Acceptance of Schedules

- (a) At least twenty (20) Days before submission of the first Application for Payment a conference, attended by Contractor, PWC, and others as appropriate, will be held to review for acceptability to Project Engineer as provided below the schedules submitted in accordance with Paragraph 2.03(a). PWC shall have ten (10) Days to review the submission and provide feedback to Contractor. Contractor shall then have ten (10) days to make any corrections and adjustments as indicated by PWC and to complete and resubmit the schedules as necessary. No progress payment shall be made to Contractor until acceptable schedules are submitted to and approved by Project Engineer.
- (b) The Progress Schedule will be acceptable to Project Engineer if it provides an orderly progression of the Work to achieve Completion of the Project within the Contract Times. Such acceptance will not impose on Project Engineer responsibility for the Progress Schedule, for sequencing, scheduling, or progress of the Work, nor interfere with or relieve Contractor from Contractor's full responsibility therefor.
- (c) Contractor's Schedule of Submittals will be acceptable to Project Engineer if it provides a workable arrangement for reviewing and processing the required submittals.

Section 2.06 Electronic Transmittals

- (a) Except as otherwise stated elsewhere in the Contract Documents, PWC and Contractor and their authorized agents may transmit, and shall accept, Project-related correspondence, text, data, documents, drawings, information, and graphics, including but not limited to Shop Drawings and other submittals, in electronic media or digital format, either directly, or through electronic mail at the address(es) designated by each Party.
- (b) When transmitting items in electronic media or digital format, the transmitting party makes no representations as to long term compatibility, usability, or readability of the items resulting from the recipient's use of software application packages, operating systems, or computer hardware differing from those used in the drafting or transmittal of the items, or from those established in applicable transmittal protocols.

Article III. Contract Documents: Intent, Requirements, Reuse

Section 3.01 Intent

- (a) The Contract Documents are complementary; what is required by one is as binding as if required by all.
- (b) It is the intent of the Contract Documents to describe a functionally complete project (or part thereof) to be constructed in accordance with the Contract Documents.
- (c) Project Engineer, Design Engineer, or both, will issue clarifications and interpretations of the Contract Documents as provided herein.
- (d) To the extent necessary that Work, construction, or conditions not covered by these General Conditions is required for Contractor to achieve Completion of the Project, "Special Conditions" for such Work will be provided to Contractor and shall be part of the Contract Documents.
- (e) In case of any inconsistency, conflict, or ambiguity among the Contract Documents, the documents shall govern in the following order: (1) Change Orders; (2) Addenda; (3) the fully executed Agreement; (4) Special Conditions; (5) any Drawings and Technical Specifications; and (6) General Conditions.

Section 3.02 Reference Standards

- (a) Standards Specifications, Codes, Laws and Regulations
 - (i) Reference in the Contract Documents to standard specifications, manuals, reference standards, or codes of any technical society, organization, or association, or to Laws or Regulations, whether such reference be specific or by implication, shall mean the standard specification, manual, reference standard, code, or North Carolina laws and regulations in effect as of the Effective Date of the Agreement, except as may be otherwise specifically stated in the Contract Documents.
 - (ii) No provision of any such standard specification, manual, reference standard, or code, or any instruction of a Supplier shall be effective to change the duties or responsibilities of PWC or Contractor, or any of their subcontractors, consultants, agents, or employees, from those set forth in the Contract Documents. No such provision or instruction shall be effective to assign to PWC or any of its officers, directors, members, partners, employees, agents, consultants, or subcontractors, any duty or authority to supervise or direct the performance of the Work or any duty or authority to undertake responsibility inconsistent with the provisions of the part of the Contract Documents.

Section 3.03 Reporting and Resolving Discrepancies

- (a) Contractor's Verification of Figures and Measurements
 - (i) Before undertaking any portion of the Work, Contractor shall review all of the Contract Documents to and check and verify all figures and dimensions for the Project. Contractor shall promptly report in writing to Project Engineer any conflict, error, ambiguity, or discrepancy that Contractor discovers, or has actual knowledge of, and shall not proceed with any Work affected thereby until the conflict, error, ambiguity, or discrepancy is

General Conditions (Rev 7/2023)

resolved, by a clarification or interpretation by Project Engineer, or by an amendment or supplement to the Contract Documents issued pursuant to these General Conditions.

- (ii) If, before or during the performance of the Work, Contractor discovers any conflict, error, ambiguity, or discrepancy within the Contract Documents, or between the Contract Documents and (a) any applicable Law or Regulation, (b) actual field conditions, (c) any standard specification, manual, reference standard, or code, or (d) any instruction of any Supplier, then Contractor shall promptly report it to Project Engineer in writing. Contractor shall not proceed with the Work affected thereby (except in an emergency as defined hereinafter) until the conflict, error, ambiguity, or discrepancy is resolved, by a clarification or interpretation by Project Engineer, or by an amendment or supplement to the Contract Documents issued pursuant to these General Conditions.

(b) Resolving Discrepancies:

- (i) Except as may be otherwise specifically stated in the Contract Documents, the provisions of the part of the Contract Documents prepared by or for PWC shall take precedence in resolving any conflict, error, ambiguity, or discrepancy between such provisions of the Contract Documents and:
 - 1) the provisions of any standard specification, manual, reference standard, or code, or the instruction of any Supplier (whether or not specifically incorporated by reference as a Contract Document); or
 - 2) the provisions of any Laws or Regulations applicable to the performance of the Work (unless such an interpretation of the provisions of the Contract Documents would result in violation of such Law or Regulation).

Section 3.04 Reuse of Documents

- (a) Contractor and its Subcontractors and Suppliers shall not have or acquire any title to or ownership rights in any of the:
 - (i) Drawings, Specifications, or other documents (or copies of any thereof) prepared by or bearing the seal of Design Engineer or its consultants, including electronic media editions, or reuse any such Drawings, Specifications, other documents, or copies thereof on extensions of the Project or any other project without written consent of PWC and Design Engineer and specific written verification or adaptation by Design Engineer, where applicable; or
 - (ii) Contract Documents and shall not reuse any such Contract Documents for any purpose without PWC's express written consent.
- (b) The prohibitions of this provision shall survive final payment or termination of the Agreement. Nothing herein shall preclude Contractor from retaining copies of the Contract Documents for record purposes.

Article IV. Commencement and Progress of the Work

Section 4.01 Commencement of Work

- (a) The Contract Times will commence to run on the day indicated in the Notice to Proceed issued by PWC to Contractor. A Notice to Proceed may be given at any time after the Effective Date of the Contract.

- (b) Contractor shall start to perform the Work on the date when the Contract Times commence to run. No Work shall be done at the Site prior to such date. Contractor's failure to commence the Work within fifteen (15) Days of the date stated in the Notice to Proceed shall be deemed a material breach of the Agreement unless PWC otherwise determines in its sole discretion and agrees in writing to a delay of the Contract Times based on the applicable circumstances.

Section 4.02 Reference Points

- (a) Construction staking will be performed by Design Engineer, who will also prepare and furnish construction cut sheets, signed and sealed by a North Carolina professional land surveyor, to PWC and Contractor. Contractor shall not install any utilities without a sheet. All requests for staking shall be made not less than 96 hours in advance.
- (b) Contractor shall be responsible for laying out the Work, shall protect and preserve the established reference points and staking, and shall make no changes or relocations without the prior written approval of Project Engineer. Contractor shall report to Project Engineer whenever any reference point staking is lost or destroyed or requires relocation because of necessary changes in grades or locations, and shall be responsible for the accurate replacement or relocation of such reference points or staking by professionally qualified personnel.

Section 4.03 Progress Schedule

- (a) Contractor shall adhere to the Progress Schedule established in accordance with Section 2.03 as it may be adjusted from time-to-time as provided below. Contractor shall submit to Project Engineer for acceptance any proposed adjustments in the Progress Schedule that will not result in changing the Contract Times. Proposed adjustments in the Progress Schedule that will change the Contract Times shall be submitted in accordance with the requirements of Article IX.
- (b) Contractor shall carry on the Work and adhere to the Progress Schedule during any disputes or disagreements with PWC. No Work shall be delayed or postponed pending resolution of any disputes or disagreements, or during any appeal process, except as permitted by these General Conditions or as PWC and Contractor may otherwise agree in writing.

Section 4.04 Delays in Contractor's Progress

- (a) If PWC, Project Engineer, anyone for whom PWC is responsible, or a Force Majeure Event delays, disrupts, or interferes with the performance or progress of the Work, then Contractor shall be entitled to an equitable adjustment in the Contract Times and Contract Price. Contractor's entitlement to an adjustment of the Contract Times is conditioned on such adjustment being essential to Contractor's ability to complete the Work within the Contract Times.
- (b) Contractor shall not be entitled to an adjustment in Contract Price or Contract Times for delay, disruption, or interference caused by or within the control of Contractor. Delay, disruption, and interference attributable to and within the control of a Subcontractor or Supplier shall be deemed to be within the control of Contractor.

- (c) Contractor must submit any Change Proposal, consistent with the procedure set forth in Article IX, seeking an adjustment in Contract Price or Contract Times under this provision within ten (10) calendar days of the commencement of the event that causes the delay, disruption, or interference with the Work and Contract Times.

Article V. Availability of Lands; Subsurface and Physical Conditions; Hazardous Environmental Conditions

Section 5.01 Availability of Lands

- (a) PWC will be responsible for obtaining any required easements and encroachments, and otherwise furnishing the Site, necessary to complete the Work, except as provided elsewhere in the Contract Documents.
- (b) Upon reasonable written request, PWC shall furnish to Contractor a current statement of record legal title and legal description of the lands upon which the Work is to be completed and PWC's interest therein.
- (c) Contractor shall provide for all additional lands and access thereto that may be required for temporary construction facilities or storage of materials and equipment necessary to complete the Work. Any and all agreements between the Contractor and any individual property owner(s) shall not obligate PWC, PWC's employees, Project Engineer, or Design Engineer in any manner, and Contractor shall, before performing any work on any such property, obtain a signed and notarized release of liability of PWC and Design Engineer that is suitable to PWC as confirmed in writing.
- (d) Contractor and any of its Subcontractors shall exercise care and caution to avoid damage to any private property. Should any such damage to private property occur, it is Contractor's responsibility to notify the Project Engineer promptly in writing that such damage occurred, the extent of the damage, and Contractor's written plan to remedy the damage. If Contractor fails to timely correct damage to private property, PWC reserves the right to withhold progress payments until damage is corrected and/or to correct damage and back-charge Contractor for costs incurred. At the Completion of the Project, Contractor shall obtain a signed release from all owners of private property to which damage occurred that releases PWC and Design Engineer and acknowledges a settlement for the damage or that such damage was adequately remedied.

Section 5.02 Use of Site and Other Areas

- (a) Contractor shall confine construction equipment, temporary construction facilities, the storage of materials and equipment, and the operations of workers to the Site and other adjacent areas permitted by Laws and Regulations and shall not unreasonably encumber the Site and such other adjacent areas with construction equipment or other materials or equipment. Contractor shall assume full responsibility for (a) damage to the Site; (b) damage to any such other adjacent areas used for Contractor's operations; (c) damage to any other adjacent land or areas; and (d) for injuries and losses sustained by the owners or occupants of any such land or areas; provided that such damage or injuries result from the performance of the Work or from other actions or conduct of the Contractor or those for which Contractor is responsible.

General Conditions (Rev 7/2023)

- (b) Contractor shall keep the Site and other adjacent areas free from accumulations of waste materials, rubbish, and other debris during the progress of the Work. Removal and disposal of such debris shall conform to applicable Laws and Regulations.
- (c) Prior to Completion of the Project, Contractor shall clean the Site and the Work and make it ready for utilization by PWC. At the completion of all of the Work, Contractor shall remove from the Site and adjacent areas all tools, appliances, construction equipment and machinery, and surplus materials and shall restore to original condition all property not designated for alteration by the Contract Documents.
- (d) Contractor shall not load nor permit any part of any structure to be loaded in any manner that will endanger the structure, nor shall Contractor subject any part of the Work or adjacent structures or land to stresses or pressures that will endanger them.

Section 5.03 Differing Subsurface or Physical Conditions or Underground Facilities

- (a) If Contractor believes that any subsurface or physical condition or Underground Facilities that is uncovered or revealed at the Site either:
 - (i) is of such a nature as to establish that any Technical Data on which Contractor is entitled to rely is materially inaccurate;
 - (ii) is of such a nature as to require a change in the Contract Documents;
 - (iii) differs materially from that shown or indicated in the Contract Documents; or
 - (iv) is of an unusual nature, and differs materially from conditions ordinarily encountered and generally recognized as inherent in work of the character provided for in the Contract Documents;

then Contractor shall, promptly after becoming aware thereof and before further disturbing the subsurface or physical conditions or Underground Facilities or performing any Work in connection therewith, notify PWC and Engineer in writing about such condition. Contractor shall not further disturb such condition or perform any Work in connection therewith (except with respect to an emergency) until receipt of a written statement approved by PWC permitting Contractor to do so.

- (b) After receipt of Contractor's written notice, Project Engineer will review the subsurface or physical condition or Underground Facilities in question; determine the necessity of PWC obtaining additional exploration or tests with respect to the condition; conclude whether the condition falls within any of the differing site condition categories in this Section 5.03; and obtain any pertinent cost or schedule information from Contractor.
- (c) Project Engineer will issue a written statement to Contractor regarding the subsurface or physical condition or Underground Facilities in question, which addresses the resumption of Work in connection with such condition and indicates whether any change in the Contract Documents will be made.
- (d) Possible Price and Times Adjustments:
 - (i) Contractor shall be entitled to an equitable adjustment in Contract Price or Contract Times, or both, to the extent that the existence of a differing subsurface or physical condition or Underground Facilities, or any related delay, disruption, or interference, causes an increase or decrease in Contractor's cost of, or time required for, performance of the Work; subject, however, to the following:

General Conditions (Rev 7/2023)

- 1) such condition must fall within at least one of the categories in this Section 5.03; and,
 - 2) Contractor's entitlement to an adjustment of the Contract Times is conditioned on such adjustment being essential to Contractor's ability to complete the Work within the Contract Times.
- (ii) Contractor shall not be entitled to any adjustment in the Contract Price or Contract Times with respect to a subsurface or physical condition or Underground Facilities if:
- 1) Contractor knew of the existence of such condition at the time Contractor proffered its Bid to PWC or executed the applicable Agreement for the Project; or
 - 2) the existence of such condition reasonably could have been discovered or revealed as a result of any examination, investigation, exploration, test, or study of the Site and contiguous areas expressly required by the Bidding Requirements or Contract Documents to be conducted by or for Contractor prior to Contractor's Bid; or
 - 3) Contractor failed to give the written notice as required.
- (iii) If PWC and Contractor agree regarding Contractor's entitlement to, and the amount or extent of, any adjustment in the Contract Price or Contract Times, or both, then any such adjustment shall be set forth in a Change Order.
- (iv) Contractor may submit a Change Proposal regarding its entitlement to or the amount or extent of any adjustment in the Contract Price or Contract Times, or both, no later than 30 calendar days after Project Engineer's written statement to Contractor regarding the subsurface or physical condition or Underground Facilities in question.

Section 5.04 Underground Utilities

- (a) Contractor shall ascertain the location and type of all underground utility lines or structures that may be located within the limits of the Site or any area where Work is to be performed.
- (i) The exact location of underground utilities or structures may vary from prior plans, permits, maps, or other documentation, and others may not be designated. The Contractor is fully responsible for verification of the exact location of all underground utility lines or structures within the limits of the Site or the area where the work is to be performed, whether known or unknown by PWC, and for providing necessary protection and/or repair if damage.
 - (ii) Should uncharted or incorrectly charted piping or other utilities be encountered during excavations, the Contractor shall immediately halt any Work, notify PWC, and await direction from PWC before proceeding with any Work. The Contractor shall fully cooperate with PWC and any other utility company in keeping respective services and facilities in operation.
- (b) PWC has used reasonable care to locate and depict existing underground installation on the construction drawings, but the accuracy cannot be guaranteed, and some items may not be shown which exist. Actual horizontal and vertical locations have not been verified. As part of the Work, the Contractor is required to dig up each utility which may conflict with construction in advance to verify locations. The utilities shall be "dug up" a minimum of fourteen (14) Days in advance of actual installation of new utilities to allow PWC an opportunity to adjust grades and alignments, to avoid a conflict, and to address

General Conditions (Rev 7/2023)

any other issues.

- (c) The Contractor shall adhere to the provisions of the North Carolina Underground Utility Safety and Damage Prevention Act. The Contractor shall make a documented request to the North Carolina One Call Center, and/or individual utility owners, in order to locate any facilities within the Site limits or any area where Work is to be performed at least forty-eight (48) hours in advance of the day the Work is scheduled to begin. The Contractor shall include the cost of any coordination and cooperation for utilities in its Bid.
- (i) Location assistance requested from PWC by Contractor should include the actual horizontal location, type number, size, and depth of all lines. All costs associated with locating and marking existing utilities or the utilities representatives shall be the responsibility of the Contractor.
- (ii) The Owner, Project Engineer, Design Engineer, and/or Consultants shall not be liable to the Contractor for any claims, costs, losses, or damages incurred or sustained on or in connection with locating existing underground installations.
- (d) If the Contractor fails to schedule locates or perform advance physical locations in advance of the construction and a conflict arises, the Contractor will be required to make corrective measures as instructed by the Project Engineer at the Contractor's expense. The Contractor's failure to advance plan (minimum fourteen (14) days) by physically uncovering existing utilities in advance of construction shall not be cause for claim of lost time or for additional compensation. No additional payment will be made for re-mobilization required by the utility locator.
- (i) The Contractor shall inform all equipment operators, either those employed by him or those employed by his subcontractors, of information obtained from the utility owners prior to initiation of any aspect of any Work.
- (e) PWC and Design Engineer shall not be responsible for the accuracy or completeness of any information or data provided to the Contractor with respect to underground facilities.
- (f) The entire cost of all of the following will be included in the Contract Price, and Contractor shall bear full responsibilities for all such costs, including but not limited to:
 - (i) Reviewing and checking all such information and data;
 - (ii) Locating all underground facilities shown or indicated in the Contract Documents;
 - (iii) Coordination of the Work with the owners of such underground facilities, including PWC, during any portion of the Work; and
 - (iv) The safety and protection of all such underground facilities and repairing any damage thereto resulting from the Work.
- (g) Contractor shall be responsible for the discovery of existing underground installations, in advance of any excavating or trenching as required in the Contract Documents.

General Conditions (Rev 7/2023)

- (h) If an underground facility is discovered at or contiguous to the Site that was not shown or indicated in the Contract Documents or of which Contractor was not aware prior to starting that portion of any Work, Contractor shall, immediately after becoming aware thereof and before further disturbing conditions affected thereby or performing any Work in connection therewith (except in an emergency), identify the owner of such underground facility and give written notice to PWC. Upon receipt of written notice, PWC will review the pertinent condition, determine the necessity of obtaining additional information, and advise Contractor in writing. During such time, Contractor shall be responsible for the safety and protection of such underground facility. If PWC concludes that a change in the Contract Documents is required, a Change Order will be issued.
- (i) The Contract Price and/or the Contract Time, may be adjusted if PWC determines, in its discretion, that the existence of such differing subsurface or physical condition causes an increase or decrease in Contractor's cost of, or time required for, performance of the Work subject to the following:
 - 1) Facility was not shown or indicated in the Contract Documents, and
 - 2) The Contractor did not know of or could not anticipate the facility.

Section 5.05 Hazardous Environmental Conditions at Site

- (a) Contractor shall not be responsible for removing or remediating any Hazardous Environmental Condition encountered, uncovered, or revealed at the Site unless such removal or remediation is expressly identified in the Contract Documents to be within the scope of the Work or Hazardous Environmental Condition was caused by Contractor.
- (b) Contractor shall be responsible for controlling, containing, and removing all Constituents of Concern brought to the Site by Contractor, Subcontractors, Suppliers, or anyone else for whom Contractor is responsible, and for any associated costs; and for the costs of removing and remediating any Hazardous Environmental Condition created by the presence of any such Constituents of Concern.
- (c) If Contractor encounters, uncovers, or reveals a Hazardous Environmental Condition whose removal or remediation is not expressly identified in the Contract Documents as being within the scope of the Work, or if Contractor or anyone for whom Contractor is responsible creates a Hazardous Environmental Condition, then Contractor shall immediately: (1) secure or otherwise isolate such condition; (2) stop all Work in connection with such condition and in any area affected thereby (except in an emergency); and (3) immediately notify Project Engineer (and promptly thereafter confirm such notice in writing). Project Engineer will evaluate such condition or take corrective action, if any. If Contractor or anyone for whom Contractor is responsible created the Hazardous Environmental Condition in question, then PWC may have the Hazardous Environmental Condition removed and remediated and impose a set-off against payments to Contractor to account for the reasonable associated costs.
- (d) Contractor shall not resume Work in connection with such Hazardous Environmental Condition or in any affected area until after PWC has delivered written notice to Contractor either (1) specifying that such condition and any affected area is or has been rendered safe for the resumption of Work, or (2) specifying any special conditions under which such Work may be resumed safely.

General Conditions (Rev 7/2023)

- (e) If PWC and Contractor cannot agree as to entitlement to or on the amount or extent, if any, of any adjustment in Contract Price or Contract Times, or both, as a result of such Work stoppage or such special conditions under which Work is agreed to be resumed by Contractor, then within thirty (30) calendar days of PWC's written notice regarding the resumption of Work, Contractor may submit a Change Proposal or PWC may impose a set-off.
- (f) If after receipt of such written notice Contractor does not agree to resume such Work based on reasonable evidence it is unsafe or does not agree to resume such Work under such special conditions, then PWC may order the portion of the Work that is in the area affected by such condition to be deleted from the Work.

Article VI. Bonds and Insurance

Section 6.01 Performance and Payment Bonds

- (a) Contractor shall obtain and furnish to PWC a performance bond in the amount of one hundred percent (100%) of the Contract Price, conditioned upon the faithful performance of the Project and all Work in accordance with the Contract Documents, which bond shall be solely for the protection of PWC.
- (b) Contractor shall obtain and furnish to PWC a payment bond in the amount of one hundred percent (100%) of the Contract Price, conditioned upon the prompt payment for all labor or materials for which the Contractor or one or more of its subcontractors is liable, which payment bond shall be solely for the protection of the persons furnishing materials or performing labor for which the Contractor is liable.
- (c) The performance bond and the payment bond shall be executed by one or more surety companies legally authorized to do business in the State of North Carolina, shall become effective upon the awarding of the construction contract by PWC to Contractor, and shall at all times comply with the requirements set forth in Article 3 of North Carolina General Statutes Chapter 44A.
- (d) In the event PWC deems the surety or sureties upon any bond necessary for the Agreement and the completion of the Project, or if for any reason, such bond ceases to be adequate to cover the performance and/or payment of the Work, Contractor shall, at its expense, and within ten (10) days after the receipt of notice from PWC, furnish such additional bond(s) in such form and amount, and with such surety or sureties, as shall be satisfactory to PWC. In such event no further payment to Contractor shall be deemed to be due under this Agreement until new or additional security for the performance and payment of the Project shall be furnished in manner and form satisfactory to PWC.
- (e) By executing the Agreement, Contractor understands and acknowledges that PWC, as a public authority, and the City, as a municipal corporation, are not subject to the provisions of Articles 1 and 2 of Chapter 44A of the General Statutes, in accordance with G.S. 44A-34 and applicable law.

Section 6.02 Insurance

- (a) Contractor shall maintain during the life of the Agreement and during the completion of any Work the following insurance coverages, which insurance shall be placed with insurance companies authorized to do business in the State of North Carolina and rate A minus VII or

General Conditions (Rev 7/2023)

better by the current edition of Best's Key Rating Guide or otherwise approved in writing by PWC:

- (i) Commercial general liability insurance with limits of \$1,000,000 per occurrence, \$2,000,000 aggregate other than products/completed operations; \$2,000,000 aggregate for products/completed. Commercial general liability coverage shall be written on an "occurrence" basis.
- (ii) Automobile liability insurance in an amount not less than \$1,000,000 combined single limit per accident for bodily injury and property damage from owned, non-owned, and hired automobiles.
- (iii) Workers' compensation insurance as required by the Laws and Regulations. In the event any employee(s), contractor(s), or subcontractor(s) engaged to perform any Work under the Agreement is not protected under the applicable workers' compensation laws, the Contractor shall provide adequate coverage for the protection of such employee(s), contractor(s), or subcontractor(s) not otherwise protected.
- (iv) In the event the Project concerns building construction or repair work, Contractor shall purchase and maintain "Builder's Risk" insurance. This insurance shall include the interests of the PWC, Contractor, and any Subcontractor(s) and shall be written on a one hundred percent (100%) completed value basis (full value as of the date that all construction is finished and includes the Contractor's Contract Price), and to remain in force until Completion of the Project.
- (v) Regardless of the nature of the work to be performed, coverage must also be provided for the theft or damage of building materials and supplies, which are not permanently attached or stored on Site for any period of time. This coverage shall be an "Installation Floater." If no building construction or repair is involved for the Project, the amount of the coverage shall equal the value of the materials stored on site.
- (b) Prior to initiating any Work on the Project, Contractor shall deliver certificates of insurance confirming each such coverage set forth above, and Contractor shall direct its insurers to provide annually to PWC certificates confirming each such coverage during the coverage period.
- (c) PWC shall be named as an additional insured in the comprehensive automobile and commercial liability insurance policies.
- (d) Contractor shall not reduce or allow the required insurance coverages to lapse without PWC's prior written approval. All policies for insurance must be endorsed to contain a provision giving PWC a thirty (30) calendar day prior written notice by certified mail of any cancellation of that policy or material reduction in coverage. Should a notice of cancellation be issued for non-payment of premiums or any part thereof, or should Contractor fail to provide and maintain certificates as set forth herein, PWC shall have the right, but shall not have the obligation, to pay such premium to the insurance company or to obtain such coverage and to deduct such payment from any sums that may be due or become due to Contractor, or to seek reimbursement for said payments from Contractor. Any such sums paid by PWC shall be due and payable immediately by Contractor upon notice from PWC.
- (e) The insurance coverage requirements shall not be construed as a limitation on

Contractor's responsibilities and liabilities pursuant to the terms and conditions of this Agreement. Contractor's obligation to maintain insurance for three (3) years after Completion of the Project shall survive the termination of this Agreement.

- (f) If Contractor fails to obtain and maintain any required insurance, PWC may exclude Contractor from the Site, impose an appropriate set-off against payment, and exercise PWC's termination rights pursuant to the Contract Documents.
- (g) PWC does not represent that insurance coverage and limits established in this Contract necessarily will be adequate to protect Contractor or Contractor's interests.

Article VII. Contractor's Responsibilities

Section 7.01 Supervision and Superintendence

- (a) Contractor shall supervise, inspect, and direct the Work competently and efficiently, devoting such attention and applying such skills and expertise as may be necessary to perform the Work in accordance with the Contract Documents. Contractor shall be solely responsible for the means, methods, techniques, sequences, and procedures of construction subject to the terms, provisions, and specifications set forth in the Contract Documents.
- (b) At all times during the progress of the Work, Contractor shall assign a competent superintendent, satisfactory to Project Engineer, to supervise the Work and to respond to Project Engineer concerning PWC's interests in the Work.
- (c) Contractor's superintendent shall have full authority to act on behalf of Contractor and all communications, instructions, directions, and notices given to the superintendent by the Project Engineer shall be binding to the Contractor.
- (d) Contractor's superintendent shall be responsible for coordination of the Work with other contractors or subcontractors. The superintendent shall not be replaced without written notice to PWC except under extraordinary circumstances.
- (e) Subcontractors
 - (i) Contractor shall submit the names and references all Subcontractors to the Project Engineer for approval before commencing any Work.
 - 1) In the event Contractor seeks to substitute any Subcontractor that was identified in Contractor's Bid, Contractor shall promptly provide PWC with: (1) the Subcontractor it seeks to substitute; (2) the identity of the Subcontractor to be substituted; and (3) the reason for the requested substitution.
 - 2) PWC will review the requested substitution within five (5) Business Days and provide written approval or denial of the substitution, with such approval not to be unreasonably withheld.
 - (ii) Contractor's superintendent shall be available to be present at the Site at any time that any Subcontractor(s) is performing any of the Work. Construction activity shall be

stopped if the Contractor's superintendent is not available to be at the Site.

Section 7.02 Labor; Working Hours

- (a) Contractor shall provide competent, suitably qualified personnel to survey and lay out the Work and perform construction as required by the Contract Documents. Contractor shall at all times maintain good discipline and order at the Site. Contractor shall remove from the Project any person who appears incompetent, disorderly, or otherwise unsatisfactory. Contractor shall also remove any person who appears in PWC's sole discretion to be incompetent, disorderly, or otherwise unsatisfactory
- (b) Except as otherwise required for the safety or protection of persons or the Work or property at the Site or adjacent thereto, and except as otherwise stated in the Contract Documents, all Work at the Site shall be performed on Business Days. Contractor will not perform Work on non-Business Days. Contractor may perform Work outside regular working hours or on Saturdays, Sundays, or legal holidays only with PWC's written consent, which will not be unreasonably withheld. In such circumstances, Contractor shall submit a written request to PWC at least two (2) Business Days prior to any Work that it requests to complete on a non-Business Day and PWC will, in its sole discretion, approve or deny such request. If such work outside of a Business Day is approved, PWC will set forth the specific parameters that Contractor must follow, including time of work, personnel, and any other issues.⁸

Section 7.03 Services, Materials, and Equipment

- (a) Unless otherwise specified in the Contract Documents, Contractor shall provide and assume full responsibility for all services, materials, equipment, labor, transportation, construction equipment and machinery, tools, appliances, fuel, power, light, heat, telephone, water, sanitary facilities, temporary facilities, and all other facilities and incidentals necessary for the performance, testing, start up, and Completion of the Project, whether or not such items are specifically called for in the Contract Documents.
- (b) All materials and equipment incorporated into the Work shall be of good quality and new, except as otherwise specified in the Contract Documents. All special warranties and guarantees required by the Specifications shall expressly run to the benefit of PWC. If required by PWC or its designee, Contractor shall furnish satisfactory evidence (including reports of required tests) as to the source, kind, and quality of materials and equipment.
- (c) All materials and equipment shall be stored, applied, installed, connected, erected, protected, used, cleaned, and conditioned in accordance with instructions of the applicable Supplier, except as otherwise may be specified in the Contract Documents.

Section 7.04 "Or Equals"

- (a) Whenever an item of material or equipment is specified or described in the Contract Documents by using the name of a proprietary item or the name of a particular Supplier, the specification or description of such an item is intended to establish the type, function, appearance, and quality required. Unless the specification or description contains or is followed by words reading that no like, equivalent, or "or equal" item is permitted, Contractor may request that Project Engineer authorize the use of other items of material or equipment under the circumstances described below.

General Conditions (Rev 7/2023)

- (i) If Project Engineer determines that an item of material or equipment proposed by Contractor is functionally equal to that named and sufficiently similar so that no change in related Work will be required, Project Engineer shall deem it an “or equal” item and confirm such in writing to Contractor. A proposed item of material or equipment will be considered functionally equal to an item so named if:
 - 1) in the exercise of reasonable judgment Project Engineer determines that:
 - a) it is at least equal in materials of construction, quality, durability, appearance, strength, and design characteristics;
 - b) it will reliably perform at least equally well the function and achieve the results imposed by the design concept of the completed Project as a functioning whole;
 - c) it has a proven record of performance and availability of responsive service; and
 - d) it is not objectionable to PWC.
 - 2) Contractor certifies that, if approved and incorporated into the Work:
 - a) there will be no increase in the Contract Price or Contract Times; and
 - b) it will conform substantially to the detailed requirements of the item specified in the Contract Documents.
- (b) Contractor shall provide all data in support of any proposed “or equal” item at Contractor’s expense.
- (c) Project Engineer will be allowed a reasonable time to evaluate each “or-equal” request. Project Engineer may require Contractor to furnish additional data about the proposed “or-equal” item. Project Engineer will be the sole judge of acceptability. Contractor shall not order, furnish, install, or utilize any “or-equal” it until Project Engineer has reviewed the request, determined that the proposed item is an “or-equal,” and provided written confirmation to Contractor.
- (d) Project Engineer’s denial of an “or-equal” request shall be final and binding and may not be reversed through an appeal under any provision of the Contract Documents.

Section 7.05 Concerning Subcontractors, Suppliers, and Others

- (a) Contractor may retain Subcontractors and Suppliers for the performance of parts of the Work. Such Subcontractors and Suppliers must be acceptable to PWC.
- (b) Contractor shall not subcontract more than forty-nine percent (49%) of the final Contract Price.
- (c) Contractor shall retain specific Subcontractors, Suppliers, or other individuals or entities for the performance of designated parts of the Work if required by the Contract Documents.
- (d) After the submittal of Contractor’s Bid or final negotiation of the terms of the Agreement, PWC may not require Contractor to retain any Subcontractor, Supplier, or other individual or entity to furnish or perform any of the Work.
- (e) Prior to entry into any binding subcontract or purchase order, Contractor shall submit to PWC the identity of the proposed Subcontractor or Supplier (unless PWC has already deemed such proposed Subcontractor or Supplier acceptable, during the bidding process

General Conditions (Rev 7/2023)

or otherwise). Such proposed Subcontractor or Supplier shall be deemed acceptable to PWC unless PWC raises a substantive, reasonable objection within five (5) Business Days.

- (f) No acceptance by PWC of any such Subcontractor, Supplier, or other individual or entity, whether initially or as a replacement, shall constitute a waiver of the right of PWC to the completion of the Work in accordance with the Contract Documents.
- (g) Contractor shall be fully responsible to PWC for all acts and omissions of the Subcontractors, Suppliers, and other individuals or entities performing or furnishing any of the Work just as Contractor is responsible for Contractor's own acts and omissions.
- (h) Contractor shall be solely responsible for scheduling and coordinating the Subcontractors, Suppliers, and all other individuals or entities performing or furnishing any of the Work.
- (i) Contractor shall restrict all Subcontractors, Suppliers, and such other individuals or entities performing or furnishing any of the Work from communicating with PWC, except through Contractor or in case of an emergency, or as otherwise expressly allowed herein.
- (j) All Work performed for Contractor by a Subcontractor or Supplier shall be pursuant to an appropriate contractual agreement that specifically binds the Subcontractor or Supplier to the applicable terms and conditions of the Contract Documents for the benefit of PWC.
- (k) PWC may furnish to any Subcontractor or Supplier, to the extent practicable, information about amounts paid to Contractor on account of Work performed for Contractor by the particular Subcontractor or Supplier.
- (l) Nothing in the Contract Documents:
 - (i) shall create for the benefit of any such Subcontractor, Supplier, or other individual or entity any contractual relationship between PWC or Design Engineer and any such Subcontractor, Supplier, or other individual or entity; nor
 - (ii) shall create any obligation on the part of PWC or Design Engineer to pay or to see to the payment of any money due any such Subcontractor, Supplier, or other individual or entity except as may otherwise be required by Laws and Regulations.

Section 7.06 Patent Fees and Royalties

- (a) Contractor shall pay all license fees and royalties and assume all costs incident to the use in the performance of the Work or the incorporation in the Work of any invention, design, process, product, or device that is the subject of patent rights or copyrights held by others. If a particular invention, design, process, product, or device is specified in the Contract Documents for use in the performance of the Work and if, to the actual knowledge of PWC, its use is subject to patent rights or copyrights calling for the payment of any license fee or royalty to others, the existence of such rights shall be disclosed by PWC in the Contract Documents.

Section 7.07 Permits

- (a) Unless otherwise specified in the Contract Documents, Contractor shall obtain and pay for all construction permits and licenses necessary to achieve Completion of the Project. Contractor shall timely seek assistance from PWC if necessary to obtain any permits or

General Conditions (Rev 7/2023)

licenses; provided that, the Contract Time shall not be extended if PWC determines, in its discretion, that Contractor delayed or otherwise did not act expeditiously in requesting such assistance. PWC shall assist Contractor, when necessary, in obtaining such permits and licenses. Contractor shall pay all governmental charges and inspection fees necessary for Completion of the Project that are applicable at the time of the submission of Contractor's Bid.

Section 7.08 Taxes

- (a) Contractor shall pay all sales, consumer, use, and other similar taxes required to be paid by Contractor in accordance with the applicable Laws and Regulations for the Project and which are applicable during the performance of the Work.

Section 7.09 Laws and Regulations

- (a) Contractor shall give all notices required by, and shall comply with, all Laws and Regulations applicable to the Project. Except as otherwise expressly required, PWC shall not be responsible for monitoring Contractor's compliance with any Laws or Regulations.
- (b) Contractor shall bear all resulting costs and losses for any of its actions or inactions that are contrary to Laws or Regulations.
- (c) PWC or Contractor may give notice to the other party of any changes after the submission of Contractor's Bid (or after the date when Contractor became bound under the Agreement) concerning any Laws or Regulations having an effect on the Contract Price or Contract Times, including but not limited to changes in Laws or Regulations having an effect on procuring permits and on sales, use, value-added, consumption, and other similar taxes. If PWC and Contractor are unable to agree on entitlement to or on the amount or extent, if any, of any adjustment in Contract Price or Contract Times resulting from such changes, then within 30 calendar days of such notice Contractor may submit a Change Proposal.

Section 7.10 Record Documents

- (a) Contractor shall maintain in good order one (1) printed record copy of all Drawings, Specifications, Addenda, Change Orders, Work Change Directives, Field Orders, written interpretations and clarifications, and approved Shop Drawings. These record documents, together with all approved Samples, will be available to Project Engineer for reference. Upon completion of the Work, Contractor shall deliver these record documents to PWC.

Section 7.11 Safety and Protection

- (a) Contractor shall be solely responsible for initiating, maintaining, and supervising all safety precautions and programs in connection with the Work. Such responsibility does not relieve Subcontractors of their responsibility for the safety of persons or property in the performance of their work, nor for compliance with applicable safety Laws and Regulations. Contractor shall take all necessary precautions for the safety of, and shall provide the necessary protection to prevent damage, injury, or loss to:
 - (i) all persons on the Site or who may be affected by the Work;
 - (ii) all the Work and materials and equipment to be incorporated therein, whether in storage on or off the Site; and

General Conditions (Rev 7/2023)

- (iii) other property at the Site or adjacent thereto, including trees, shrubs, lawns, walks, pavements, roadways, structures, other work in progress, utilities, and Underground Facilities not designated for removal, relocation, or replacement in the course of construction.
- (b) Contractor shall comply with all applicable Laws and Regulations relating to the safety of persons or property, or to the protection of persons or property from damage, injury, or loss, and shall erect and maintain all necessary safeguards for such safety and protection. Contractor shall notify PWC, the owners of adjacent property or Underground Facilities, and other contractors and owners performing work at or adjacent to the Site, when prosecution of the Work may affect them, and shall cooperate with them in the protection, removal, relocation, and replacement of their property or work in progress.
- (c) Contractor shall comply with the requirement of any of PWC's applicable health programs, which may be revised from time to time based on specific circumstances or applicable guidance from the Center for Disease Control or other applicable entity. Such health programs will be identified in the Special Conditions if applicable to the Project.
- (d) Contractor shall comply with the requirements of PWC's applicable safety programs. The Special Conditions identify any of PWC's safety programs that are applicable to the Project.
- (e) Contractor shall remedy, at its expense, all damage, injury, or loss to any property caused, directly or indirectly, in whole or in part, by Contractor, any Subcontractor, Supplier, or any other individual or entity directly or indirectly employed by any of them to perform any of the Work, or anyone for whose acts any of them may be liable.
- (f) Contractor's duties and responsibilities for safety and protection shall continue until such time as Completion of the Project is achieved.
- (g) Contractor's duties and responsibilities for safety and protection shall resume whenever Contractor or any Subcontractor or Supplier returns to the Site to fulfill warranty or correction obligations, or to conduct other tasks arising from the Contract Documents.
- (h) Contractor shall designate in writing to PWC a qualified and experienced safety representative at the Site whose duties and responsibilities shall be the prevention of accidents and the maintaining and supervising of safety precautions and programs.

Section 7.12 Emergencies

- (a) In emergencies affecting the safety or protection of persons or the Work or property at the Site or adjacent thereto, Contractor is obligated to, and shall, act to prevent threatened damage, injury, or loss. Contractor shall give PWC prompt written notice if Contractor believes that any significant changes in the Work or variations from the Contract Documents have been caused or are required as a result of any emergency. If PWC determines that a change in the Contract Documents is required because of the action taken by Contractor in response to such an emergency, a Work Change Directive or Change Order will be issued.

Section 7.13 Shop Drawings, Samples, and Other Submittals

- (a) Contractor shall timely submit Shop Drawings and Samples required by the Contract

General Conditions (Rev 7/2023)

Documents to Project Engineer for review and approval in accordance with applicable specifications.

- (b) Before submitting a Shop Drawing or Sample, Contractor shall have
 - (i) reviewed the Shop Drawing or Sample with other Shop Drawings and Samples and with the requirements of the Work and the Contract Documents;
 - (ii) verified all measurements, quantities, dimensions, performance and design criteria, installation requirements, materials, catalog numbers, and similar information;
 - (iii) verified the suitability of all materials and equipment offered with respect to the indicated application, fabrication, shipping, handling, storage, assembly, and installation pertaining to the performance of the Work; and
 - (iv) verified all information relative to Contractor's responsibilities for means, methods, techniques, sequences, and procedures of construction, and safety precautions and programs incident thereto.
- (c) With each submittal, Contractor shall give Project Engineer specific written notice of any variations that the Shop Drawing or Sample may have from the requirements of the Contract Documents. This notice shall be a written communication separate from the Shop Drawings or Sample submittal; and, in addition, in the case of Shop Drawings by a specific notation made on each Shop Drawing submitted to PWC for review and approval of each such variation.
- (d) Where a Shop Drawing or Sample is required by the Contract Documents, any related Work performed prior to Project Engineer's review and approval of the pertinent submittal will be at the sole expense and responsibility of Contractor.
- (e) Project Engineer will provide timely review of any required Shop Drawings and Samples. Such review, and subsequent determination of approval, will be only to determine if the items covered by the submittals will, after installation or incorporation in the Work, conform to the information given in the Contract Documents and be compatible with the design concept of the completed Project as a functioning whole as indicated by the Contract Documents.
- (f) Project Engineer's review and approval will not extend to means, methods, techniques, sequences, or procedures of construction or to safety precautions or programs incident thereto.
- (g) Project Engineer's review and approval of a Shop Drawing or Sample, or of a variation from the requirements of the Contract Documents, shall not change the Contract Times or Contract Price, unless such changes are included in a Change Order.
- (h) Project Engineer's receipt, review, acceptance or approval of a Shop Drawing, Sample, or other submittal shall not result in such item becoming a Contract Document.
- (i) Contractor shall perform the Work in compliance with the requirements and commitments set forth in approved Shop Drawings and Samples.
- (j) Resubmittal Procedures:
 - (i) Contractor shall make corrections required by Project Engineer and shall return the

General Conditions (Rev 7/2023)

required number of corrected copies of Shop Drawings and submit new Samples as required for review and approval. Contractor shall direct specific attention in writing to revisions other than the corrections called for by PWC or Project Engineer on previous submittals.

- (ii) Contractor shall furnish required submittals with sufficient information and accuracy to obtain required approval of an item with no more than three (3) submittals. If PWC has engaged a Design Engineer for the Project, Design Engineer will record Design Engineer's time for reviewing a fourth or subsequent submittal of a Shop Drawings, sample, or other item requiring approval, and Contractor shall be responsible for Design Engineer's charges to PWC for such time. PWC may impose a set-off against payments due to Contractor to secure reimbursement for such charges.
- (iii) If Contractor requests a change of a previously approved submittal item, Contractor shall be responsible for Design Engineer's charges to PWC for its review time, and PWC may impose a set-off against payments due to Contractor to secure reimbursement for such charges, unless the need for such change is beyond the control of Contractor.

Section 7.14 Contractor's General Warranty and Guarantee

- (a) In order to induce PWC to enter into an Agreement with Contractor for the Project, Contractor warrants and guarantees to PWC that:
 - (i) Contractor is duly licensed in the State of North Carolina to complete all Work necessary for the Project, is duly organized, validly existing and in good standing and has all requisite powers, rights, and authority to execute, enter into, and perform the Agreement in accordance with the terms and conditions of the Agreement, and the Agreement constitutes a legal, valid, and binding obligation of Contractor enforceable against it in accordance with its terms.
 - (ii) Contractor has read the Contract Documents, and acknowledges and understands all data, materials, specifications, and requirements identified in the Contract Documents.
 - (iii) Contractor has visited the site for the Project, conducted a thorough, visual examination of the site and adjacent areas, and become familiar with and is satisfied as to the general, local, and site conditions that may affect cost, progress, and performance in completing the Project.
 - (iv) Contractor is familiar with and is satisfied as to all laws and regulations that may affect cost, progress, and performance to complete the Project.
 - (v) Contractor has carefully studied all: (1) reports of explorations and tests of subsurface conditions at or adjacent to the site and all drawings of physical conditions relating to existing surface or subsurface structures at the site that have been identified in the Detail Specifications and any accompanying reports and drawings, and (2) reports and drawings relating to any Hazardous Environmental Condition at or adjacent to the site that have been identified in the Contract Documents and any accompanying reports and drawings.
 - (vi) Contractor has considered the information known to Contractor itself; information commonly known to contractors doing business in the locality of the Site; information and observations obtained from visits to the Site; the Contract Documents; and the Site-related reports and drawings identified in the Contract Documents, if any, with respect to the effect of such information, observations, and documents on (1) the cost, progress, and performance of the Work; (2) the means, methods, techniques, sequences, and procedures of construction to be employed by Contractor; and (3) Contractor's safety precautions and programs.

General Conditions (Rev 7/2023)

- (vii) Based on the information and observations referred to in subsection “(v)” of this Section, Contractor agrees that no further examinations, investigations, explorations, tests, studies, or data are necessary for the performance of the Work at the Contract Price and in accordance with the other terms and conditions of the Contract Documents.
 - (viii) Contractor is aware of the general nature of work to be performed by PWC and others at the Site that relates to the Work as indicated in the Contract Documents.
 - (ix) Contractor has given PWC written notice of all conflicts, errors, ambiguities, or discrepancies that Contractor has discovered in the Contract Documents, and the written resolution thereof by PWC is acceptable to Contractor.
 - (x) The Contract Documents are generally sufficient to indicate and convey understanding of all terms and conditions for performance and furnishing of the Work.
 - (xi) Contractor’s entry into this Agreement constitutes an incontrovertible representation by Contractor that, without exception, all prices in the Agreement are premised upon performing and furnishing the Work required by the Contract Documents.
 - (xii) Contractor has no business or personal relationship with any PWC Commissioner, officer, director, manager, or supervisor and Contractor covenants to disclose immediately to PWC any such relationship that develops during the performance of Work on the Project.
- (b) Contractor’s obligation to perform and complete the Work in accordance with the Contract Documents shall be absolute. None of the following will constitute an acceptance of Work that is not in accordance with the Contract Documents or a release of Contractor’s obligation to perform the Work in accordance with the Contract Documents:
- (i) observations by Project Engineer;
 - (ii) recommendation by Project Engineer or payment by PWC of any progress or final payment;
 - (iii) the issuance of a certificate of Substantial Completion by Project Engineer or any payment related thereto by PWC;
 - (iv) use or occupancy of the Work or any part thereof by PWC;
 - (v) any review and approval of a Shop Drawing or Sample submittal;
 - (vi) the issuance of a notice of acceptability by Project Engineer;
 - (vii) any inspection, test, or approval by others; or
 - (viii) any correction of defective Work by PWC.
- (c) If the Contract Documents requires the Contractor to accept the assignment of a contract entered into by PWC, then the specific warranties, guarantees, and correction obligations contained in the assigned contract shall govern with respect to Contractor’s performance obligations to PWC for the Work described in the assigned contract.

Section 7.15 Indemnification

- (a) Contractor shall indemnify, defend, and hold harmless PWC and its Commissioners, officers, employees, agents, and representatives and the City and its elected officials, managers, employees, agents, and representatives and Designer (collectively “Indemnitees”) from and against all claims, actions, liabilities, damages, losses, costs, and expenses (including, without limitation, injury to or death of any persons and damage to property, economic and consequential damages and attorneys’ fees) asserted by one or more third parties against one or more of the Indemnitees if the Fault of one or more Responsible Persons is a proximate cause of the loss, damage, or expense indemnified.
- (b) Contractor’s obligation to indemnify, defend, and hold harmless the Indemnitees shall survive the termination of the Agreement.

- (c) In any and all claims against the Indemnitees of Contractor, any Subcontractor, any Supplier, or any individual or entity directly or indirectly employed by any of them to perform any of the Work, or anyone for whose acts any of them may be liable, Contractor's indemnification obligation shall not be limited in any way by any limitation on the amount or type of damages, compensation, or benefits payable by or for Contractor or any such Subcontractor, Supplier, or other individual or entity under workers' compensation acts, disability benefit acts, or other employee benefit acts.

Section 7.16 Claims Procedure

- (a) PWC shall notify the Contractor of all potential claims related to the Work within seven (7) calendar days of receiving notification or having knowledge of such potential claim. Should the Contractor receive a potential claim related to the Work, the Contractor shall notify PWC within seven (7) calendar days of receiving notification. The Contractor shall provide the claimant and PWC with a written response acknowledging receipt of the claim within seven (7) calendar days.
- (b) If the Contractor meets with the Claimant about the claim, a representative designated by PWC shall be present at all times. PWC shall maintain a record of any claim received, and the steps taken to resolve. PWC shall also concurrently investigate each case. The Contractor agrees to furnish PWC any information regarding the claim, the actions which led to the claim and/or the investigation of the claim. Contractor shall provide their proposed response to PWC within thirty (30) calendar days of receiving the claim. Upon receipt of the response PWC and the Contractor will discuss and reach a mutual agreement of the response necessary to send to the Claimant within fifteen (15) calendar days. Once the agreement is made the Contractor shall make a formal written resolution to the claimant.
- (c) Failure to act in good faith or respond to a claim in the timelines established by the Contract Documents will constitute a lack of response by the Contractor, therefore validating the claim. PWC will deduct the total amount of the claim from the monthly pay application. Failure to comply with the above requirements for resolving claims may, at the sole discretion of PWC, result in breach of contract.
- (d) The Contractor is aware of these claims procedures and understands that it is the PWC's practice to pursue reimbursement/subrogation for any and all claims related expenses, which are incurred as a result of the Contractor's performance under this Contract Documents and allowed within the applicable statute of limitations.

Section 7.17 Delegation of Professional Design Services

- (a) Contractor will not be required to provide professional design services unless such services are specifically required by the Contract Documents for a portion of the Work or unless such services are required to carry out Contractor's responsibilities for construction means, methods, techniques, sequences and procedures. Contractor shall not be required to provide professional services in violation of applicable Laws and Regulations.
- (b) If professional design services or certifications by a design professional related to systems, materials, or equipment are specifically required of Contractor by the Contract Documents, PWC will specify all performance and design criteria that such services must satisfy.

General Conditions (Rev 7/2023)

Contractor shall cause such services or certifications to be provided by a properly licensed professional, whose signature and seal shall appear on all drawings, calculations, specifications, certifications, and other submittals prepared by such professional. Shop Drawings and other submittals related to the Work designed or certified by such professional, if prepared by others, shall bear such professional's written approval when submitted to PWC.

- (c) PWC shall be entitled to rely upon the adequacy, accuracy, and completeness of the services, certifications, or approvals performed by such design professionals, provided PWC has specified to Contractor all performance and design criteria that such services must satisfy.
- (d) Pursuant to this Section, PWC's, or its designee's, review and approval of design calculations and design drawings will be only for the limited purpose of checking for conformance with performance and design criteria given and the design concept expressed in the Contract Documents. PWC specifically retains final approval of such submittals.
- (e) Contractor shall not be responsible for the adequacy of the performance or design criteria specified by PWC.

Article VIII. PWC's Responsibilities

- (a) In awarding the bid to Contractor and executing the applicable Agreement, PWC acknowledges the following responsibilities:
 - (i) Except as otherwise provided in these General Conditions, PWC shall issue all communications directly to Contractor or its designee.
 - (ii) PWC may at its discretion replace Design Engineer and Project Engineer. The replacement Design Engineer or Project Engineer's status under the Contract Documents shall be that of the former Design Engineer or Project Engineer.
 - (iii) PWC shall promptly furnish the data required of PWC under the Contract Documents.
 - (iv) PWC shall make payments to Contractor when they are due as provided in the Contract Documents.
 - (v) PWC shall not supervise, direct, or have control or authority over, nor be responsible for, Contractor's means, methods, techniques, sequences, or procedures of construction, or the safety precautions and programs incident thereto, or for any failure of Contractor to comply with Laws and Regulations applicable to the performance of the Work. PWC will not be responsible for Contractor's failure to perform the Work in accordance with the Contract Documents.
 - (vi) Upon request of Contractor, PWC shall furnish to Contractor reasonable evidence that financial arrangements have been made to satisfy PWC's obligations under the Contract Documents (including obligations under proposed changes in the Work).
 - (vii) While at the Site, PWC's employees and representatives shall comply with the specific applicable requirements of Contractor's safety programs of which PWC has been informed.
 - (viii) PWC shall furnish copies of any applicable PWC safety program(s) to Contractor, which Contractor shall review and implement.

Article IX. Amending the Contract Documents; Changes in the Work

Section 9.01 Amending and Supplementing Contract Documents

- (a) The Contract Documents may be amended or supplemented by a Change Order, a Work Change Directive, or a Field Order.
 - (i) Change Orders: If an amendment or supplement to the Contract Documents includes a change in the Contract Price or the Contract Times, such amendment or supplement must be set forth in a Change Order. A Change Order also may be used to establish amendments and supplements of the Contract Documents that do not affect the Contract Price or Contract Times.
 - (ii) Work Change Directives: A Work Change Directive will not change the Contract Price or the Contract Times, but is evidence that the parties expect that the modification ordered or documented by a Work Change Directive will be incorporated in a subsequently issued Change Order, following negotiations by the parties as to the Work Change Directive's effect, if any, on the Contract Price and Contract Times; or, if negotiations are unsuccessful, by a determination under the terms of the Contract Documents governing adjustments, expressly including Paragraph 9.04 regarding change of Contract Price. Contractor must submit any Change Proposal seeking an adjustment of the Contract Price or the Contract Times, or both, no later than 30 days after the completion of the Work set out in the Work Change Directive. PWC must submit any dispute or request seeking an adjustment of the Contract Price or the Contract Times, or both, no later than 60 days after issuance of the Work Change Directive.
 - (iii) Field Orders: Project Engineer may authorize minor changes in the Work if the changes do not involve an adjustment in the Contract Price or the Contract Times and are compatible with the design concept of the completed Project as a functioning whole as indicated by the Contract Documents. Such changes will be accomplished by a Field Order and will be binding on PWC and on Contractor, which shall perform promptly the Work involved. If Contractor believes that a Field Order justifies an adjustment in the Contract Price or Contract Times, or both, then before proceeding with the Work at issue, Contractor shall submit a Change Proposal as provided herein.

Section 9.02 PWC-Authorized Changes in the Work

- (a) Without invalidating the Agreement and without notice to any surety, PWC may, at any time or from time to time, order additions, deletions, or revisions in the Work. Such changes shall be supported by Design Engineer's recommendation when applicable and to the extent the change involves the design (as set forth in the Drawings, Specifications, or otherwise), or other engineering or technical matters. Such changes may be accomplished by a Change Order or by a Work Change Directive. Upon receipt of any such document, Contractor shall promptly proceed with the Work as revised. Nothing in this paragraph shall obligate Contractor to undertake work that Contractor reasonably concludes cannot be performed in a manner consistent with Contractor's safety obligations under the Contract Documents or Laws and Regulations.

Section 9.03 Unauthorized Changes in the Work

- (a) Contractor shall not be entitled to an increase in the Contract Price or an extension of the Contract Times with respect to any work performed that is not required by the Contract Documents, as amended, modified, or supplemented.

Section 9.04 Change of Contract Price

- (a) The Contract Price may only be changed by a Change Order. Any Change Proposal for an adjustment in the Contract Price shall comply with the provisions of these General Conditions.
- (b) An adjustment in the Contract Price will be determined as follows:
 - (i) where the Work involved is covered by unit prices contained in the Contract Documents, then by application of such unit prices to the quantities of the items involved; or
 - (ii) where the Work involved is not covered by unit prices contained in the Contract Documents, then by a mutually agreed lump sum (which may include an allowance for overhead and profit as agreed to in writing by the Parties); or
 - (iii) where the Work involved is not covered by unit prices contained in the Contract Documents and the Parties do not reach mutual agreement to a lump sum, then on the basis of the Cost of the Work plus a reasonable Contractor's fee for overhead and profit.
- (c) Contractor's Fee: When applicable, the Contractor's fee for overhead and profit shall be determined as follows:
 - (i) a mutually acceptable fixed fee; or
 - (ii) if a fixed fee is not agreed upon, then a fee based on the following percentages of the various portions of the Cost of the Work:
 - 1) for unit prices, the Contractor's fee shall be fifteen percent (15%);
 - 2) for all other costs incurred, the Contractor's fee shall be five percent (5%);
 - 3) the amount of credit to be allowed by Contractor to PWC for any change that results in a net decrease in the Contract Price will be the amount of the actual net decrease in cost plus a deduction in Contractor's fee by an amount equal to five percent of such net decrease; and
 - 4) when both additions and credits are involved in any one change, the adjustment in Contractor's fee shall be computed on the basis of the net change.

Section 9.05 Change of Contract Times

- (a) The Contract Times may only be changed by a Change Order. Any Change Proposal for an adjustment in the Contract Times shall comply with the provisions of Paragraph 9.06.
- (b) An adjustment of the Contract Times shall be subject to the limitations set forth in these Contract Document as it concerns delays in Contractor's progress.

Section 9.06 Change Proposals

- (a) Contractor shall submit a Change Proposal to PWC to request an adjustment in the Contract Times and/or Contract Price. The Change Proposal shall specify any proposed change in Contract Times or Contract Price, or both, or other proposed relief, and explain the reason for the proposed change, with citations to any governing or applicable provisions of the Contract Documents.
- (i) Procedures: Contractor shall submit each Change Proposal to PWC promptly (but in no event later than 30 days) after the start of the event giving rise thereto, or after such initial decision. The Contractor shall submit supporting data, including the proposed change in

General Conditions (Rev 7/2023)

Contract Price or Contract Time (if any), to PWC within 15 calendar days after the submittal of the Change Proposal. The supporting data shall be accompanied by a written statement that the supporting data are accurate and complete, and that any requested time or price adjustment is the entire adjustment to which Contractor believes it is entitled as a result of said event.

- (ii) PWC Action: PWC will review each Change Proposal and, within 30 calendar days after receipt of the Contractor's supporting data, either deny the Change Proposal in whole, approve it in whole, or deny it in part and approve it in part. Such actions shall be in writing to Contractor. If PWC does not take action on the Change Proposal within 30 calendar days, then the Change Proposal is deemed denied, thereby commencing the time for appeal under these General Conditions.
- (iii) Binding Decision: PWC's decision will be final and binding unless Contractor appeals the decision.

Section 9.07 Execution of Change Orders

- (a) PWC and Contractor shall execute appropriate Change Orders covering:
 - (i) changes in the Contract Price or Contract Times that are agreed to by the parties, including any undisputed sum or amount of time for Work performed in accordance with a Work Change Directive;
 - (ii) changes in Contract Price resulting from a PWC set-off, unless Contractor has duly contested such set-off;
 - (iii) changes in the Work which are: (a) ordered by PWC, (b) required because of PWC's acceptance of defective Work or PWC's correction of defective Work, or (c) agreed to by the parties, subject to the need for Design Engineer's recommendation if the change in the Work involves the design (as set forth in the Contract Documents), or other engineering or technical matters; and
 - (iv) changes in the Contract Price or Contract Times, or other changes, which embody the substance of any final and binding results.
- (b) If PWC or Contractor refuses to execute a Change Order that is required to be executed under the terms of this Section, it shall be deemed to be of full force and effect as if fully executed.

Section 9.08 Notification to Surety

- (a) If the provisions of any bond require notice to be given to a surety of any change affecting the general scope of the Work or the provisions of the Contract Documents (including, but not limited to, Contract Price or Contract Times), the giving of any such notice will be Contractor's responsibility. The amount of each applicable bond will be adjusted to reflect the effect of any such change.

Article X. Tests, Inspections, and Approvals; Correction, Removal, or Acceptance of Defective Work

Section 10.01 Access to Work

- (a) PWC, Design Engineer, their consultants and other representatives and personnel of PWC, independent testing laboratories, and authorities having jurisdiction will have access to the Site and the Work at reasonable times for their observation, inspection, and testing.

General Conditions (Rev 7/2023)

Contractor shall provide them proper and safe conditions for such access and advise them of Contractor's safety procedures and programs so that they may comply therewith as applicable.

Section 10.02 Tests, Inspections, and Approvals

- (a) Contractor shall give Project Engineer timely notice of readiness of the Work (or specific parts thereof) for all required inspections and tests and shall cooperate with inspection and testing personnel to facilitate required inspections and tests.
- (b) PWC shall retain and pay for the initial services of an independent inspector, testing laboratory, or other qualified individual or entity to perform all inspections and tests expressly required by the Contract Documents to be furnished and paid for by PWC, except those costs incurred in connection with tests or inspections of covered Work shall be governed by the provisions of Paragraph 10.05.
- (c) If Laws or Regulations of any public body having jurisdiction require any Work (or part thereof) specifically to be inspected, tested, or approved by an employee or other representative of such public body, Contractor shall assume full responsibility for arranging and obtaining such inspections, tests, or approvals, pay all costs in connection therewith, and furnish the required certificates of inspection or approval to PWC.
- (d) Contractor shall be responsible for arranging, obtaining, and paying for all inspections and tests required:
 - (i) by the Contract Documents, unless the Contract Documents expressly allocate responsibility for a specific inspection or test to PWC;
 - (ii) to attain PWC's and Design Engineer's acceptance of materials or equipment to be incorporated in the Work;
 - (iii) by manufacturers of equipment furnished under the Contract Documents;
 - (iv) for testing, adjusting, and balancing of mechanical, electrical, and other equipment to be incorporated into the Work; and
 - (v) for acceptance of materials, mix designs, or equipment submitted for approval prior to Contractor's purchase thereof for incorporation in the Work.

Such inspections and tests shall be performed by independent inspectors, testing laboratories, or other qualified individuals or entities acceptable to PWC, as confirmed in writing by Project Engineer to Contractor.

- (e) If the Contract Documents require the Work (or part thereof) to be approved by PWC or its designee, then Contractor shall assume full responsibility for arranging and obtaining such approvals.
- (f) If any Work (or the work of others) that is to be inspected, tested, or approved is covered by Contractor without written concurrence of Project Engineer, Contractor shall, if requested by Project Engineer, uncover such Work for observation. Such uncovering shall be at Contractor's expense unless Contractor had given PWC timely notice of Contractor's intention to cover the same and PWC had not acted with reasonable promptness in response to such notice.

Section 10.03 Defective Work

General Conditions (Rev 7/2023)

- (a) It is Contractor's obligation to assure that the Work is not defective.
- (b) PWC or its designee has the authority to determine whether Work is defective, and to reject defective Work.
- (c) Prompt notice of all defective Work of which PWC has actual knowledge will be given to Contractor.
- (d) Promptly after receipt of written notice of defective Work, Contractor shall correct all such defective Work, whether or not fabricated, installed, or completed, or, if PWC has rejected the defective Work, remove it from the Project and replace it with Work that is not defective.
- (e) When correcting defective Work, Contractor shall take no action that would void or otherwise impair PWC's special warranty and guarantee, if any, on said Work.
- (f) In addition to its correction, removal, and replacement obligations with respect to defective Work, Contractor shall pay all claims, costs, losses, and damages arising out of or relating to defective Work, including but not limited to the cost of the inspection, testing, correction, removal, replacement, or reconstruction of such defective Work, fines levied against PWC by governmental authorities because the Work is defective, and the costs of repair or replacement of work of others resulting from defective Work. Prior to final payment, if PWC and Contractor are unable to agree as to the measure of such claims, costs, losses, and damages resulting from defective Work, then PWC may impose a reasonable set-off against payments due.

Section 10.04 Acceptance of Defective Work

- (a) If, instead of requiring correction or removal and replacement of defective Work, PWC prefers to accept it, PWC may do so (subject, if such acceptance occurs prior to final payment, to Design Engineer's confirmation that such acceptance is in general accord with the design intent and applicable engineering principles and will not endanger public safety).
- (b) Contractor shall pay all claims, costs, losses, and damages attributable to PWC's evaluation of and determination to accept such defective Work (such costs to be approved by PWC as to reasonableness), and for the diminished value of the Work to the extent not otherwise paid by Contractor. If any such acceptance occurs prior to final payment, the necessary revisions in the Contract Documents with respect to the Work shall be incorporated in a Change Order.
- (c) If the parties are unable to agree as to the decrease in the Contract Price, reflecting the diminished value of Work so accepted, then PWC may impose a reasonable set-off against payments due. If the acceptance of defective Work occurs after final payment, Contractor shall pay an appropriate amount to PWC.

Section 10.05 Uncovering Work

- (a) PWC has discretion to require, at its initial cost, additional inspection or testing of the Work, whether or not the Work is fabricated, installed, or completed.
- (b) If any Work is covered contrary to the written request of PWC, then Contractor shall, if requested by PWC or its designee, uncover such Work for observation, and then replace

the covering, all at Contractor's expense.

- (c) If PWC considers it necessary or advisable that covered Work be observed by PWC or inspected or tested by others, then Contractor, at PWC's request, shall uncover, expose, or otherwise make available for observation, inspection, or testing as PWC may require, that portion of the Work in question, and provide all necessary labor, material, and equipment.
 - (i) If it is found that the uncovered Work is defective, Contractor shall be responsible for all claims, costs, losses, and damages arising out of or relating to such uncovering, exposure, observation, inspection, and testing, and of satisfactory replacement or reconstruction (including but not limited to all costs of repair or replacement of work of others); and pending Contractor's full discharge of this responsibility PWC shall be entitled to impose a reasonable set-off against payments due.
 - (ii) If the uncovered Work is not found to be defective, Contractor shall be allowed an increase in the Contract Price or an extension of the Contract Times, or both, directly attributable to such uncovering, exposure, observation, inspection, testing, replacement, and reconstruction. If the parties are unable to agree as to the amount or extent thereof, then Contractor may submit a Change Proposal within 30 calendar days of the determination that the Work is not defective.

Section 10.06 PWC May Stop the Work

- (a) If the Work is defective, or Contractor fails to supply sufficiently skilled workers or suitable materials or equipment, or fails to perform the Work in such a way that the completed Work will conform to the Contract Documents, then PWC may order Contractor to stop the Work, or any portion thereof, until the cause for such order has been eliminated; however, this right of PWC to stop the Work shall not give rise to any duty on the part of PWC to exercise this right for the benefit of Contractor, any Subcontractor, any Supplier, any other individual or entity, or any surety for, or employee or agent of any of them.

Section 10.07 PWC May Correct Defective Work

- (a) If Contractor fails within the time specified by PWC in a written notice from PWC to correct defective Work, or to remove and replace rejected Work as required by PWC, or if Contractor fails to perform the Work in accordance with the Contract Documents, or if Contractor fails to comply with any other provision of the Contract Documents, then PWC may, after seven (7) calendar days written notice to Contractor, correct or remedy any such deficiency.
- (b) In exercising the rights and remedies under this Section, PWC shall proceed expeditiously. In connection with such corrective or remedial action, PWC may exclude Contractor from all or part of the Site, take possession of all or part of the Work and suspend Contractor's services related thereto, and incorporate in the Work all materials and equipment stored at the Site or for which PWC has paid Contractor but which are stored elsewhere. Contractor shall allow PWC and its officers, employees, representatives, agents and other contractors, and Design Engineer and its employees and agents access to the Site to enable PWC to exercise the rights and remedies under this Section.
- (c) All claims, costs, losses, and damages incurred or sustained by PWC in exercising the rights and remedies under this Section will be charged against Contractor as set-offs against payments due. Such claims, costs, losses and damages will include but not be limited to all costs of repair, or replacement of work of others destroyed or damaged by

correction, removal, or replacement of Contractor's defective Work.

- (d) Contractor shall not be allowed an extension of the Contract Times because of any delay in the performance of the Work attributable to the exercise by PWC of PWC's rights and remedies under this Section.

Article XI. Claims

Section 11.01 Claims Process

- (a) The following disputes between PWC and Contractor shall be submitted to the Claims process set forth in this Article:
 - (i) Appeals by PWC or Contractor of Design Engineer's decisions regarding Change Proposals;
 - (ii) PWC or Contractor's demands for adjustments in the Contract Price or Contract Times, or other relief under the Contract Documents; and
 - (iii) Disputes that Design Engineer has been unable to address because they do not involve the design (as set forth in the Contract Documents), the acceptability of the Work, or other engineering or technical matters.

Section 11.02 Submittal of Claim

- (a) The party submitting a claim shall deliver it directly to the other party to the Agreement promptly (but in no event later than 30 calendar days) after the start of the event giving rise thereto; in the case of appeals regarding Change Proposals within 30 calendar days of the decision under appeal. The responsibility to substantiate a claim shall rest with the party making the claim. In the case of a claim by Contractor seeking an increase in the Contract Times or Contract Price, or both, Contractor shall certify that the claim is made in good faith, that the supporting data are accurate and complete, and that to the best of Contractor's knowledge and belief the amount of time or money requested accurately reflects the full amount to which Contractor is entitled.

Section 11.03 Review and Resolution

- (a) The party receiving a Claim shall review it thoroughly, giving full consideration to its merits. The two parties shall seek to resolve the Claim through the exchange of information and direct negotiations. The parties may extend the time for resolving the Claim by mutual agreement. All actions taken on a Claim shall be stated in writing and submitted to the other party.

Section 11.04 Dispute Resolution

- (a) In the event of any dispute, controversy, or claim of any kind or nature arising under or in connection with this Agreement (a "Dispute") and involving any two or more of the following parties, PWC, Design Engineer, Contractor or any subcontractor of Contractor, the party initiating the Dispute shall serve written notice of a Dispute on the party(ies) to the dispute, and those parties shall endeavor to settle the dispute first through direct, informal discussions between the parties' selected representatives. Any such representative(s) shall have binding authority to settle the Dispute. In the event the parties do not settle the Dispute within ten (10) calendar days from the date of written notice of the Dispute, any

party to the Dispute may, by written notice to the other party(ies), engage a mediator certified under the laws of the State of North Carolina to mediate the Dispute within thirty (30) calendar days of such notice. The parties to the Dispute shall attend mediation in good faith. In the event mediation is unsuccessful, any party to the dispute may initiate arbitration proceedings. Any controversy or claim arising out of or relating to the Contract Documents, or the breach thereof, shall be settled by binding arbitration administered by the American Arbitration Association under its Construction Industry Arbitration Rules, and judgment on the award rendered by the arbitrator(s) may be entered in any court having jurisdiction thereof. All of the foregoing dispute resolution procedures shall be held in Cumberland County, North Carolina. The costs of the mediator and arbitrator in a dispute resolution process shall be divided equally among the parties to the process; provided, however, PWC shall bear at least one-third of the cost if PWC is a party to the dispute resolution and the remainder of the cost shall be divided equally among the other parties participating in the dispute resolution. PWC shall, in its contractual arrangements with Design Engineer, and Contractor shall, in its contracts with Subcontractors and they in their contracts with lower-tier subcontractors authorize and direct such parties to participate in the dispute resolution procedures set forth in this Section. Unless otherwise directed in writing by PWC, Contractor shall continue the Project and maintain compliance with the scheduling deadlines set forth in the Contract Documents during any dispute resolution proceedings. If Contractor continues to perform, PWC shall make payments due for the continued performance in accordance with this Agreement. The provisions of this Section shall not extend any applicable statutes of limitation or repose.

Article XII. Payments to Contractor; Set-Offs; Completion; Correction Period

Section 12.01 Progress Payments

- (a) The Schedule of Values will serve as the basis for progress payments and will be incorporated into a form of Application for Payment acceptable to the Project Engineer. Progress payments on account of Unit Price Work will be based on the number of units completed during the pay period. Progress payments for cost-based Work will be based on the Cost of the Work completed by the Contractor during the pay period.
- (b) Applications for Payments:
 - (i) Contractor shall submit to Project Engineer for review an Application for Payment filled out and signed by Contractor covering the Work completed as of the date of the Application and accompanied by such supporting documentation as is required by the Contract Documents. If payment is requested on the basis of materials and equipment not incorporated in the Work but delivered and suitably stored at the Site or another location agreed to in writing, the Application for Payment shall also be accompanied by a bill of sale, invoice, or other documentation warranting that PWC has received the materials and equipment free and clear, and evidence that the materials and equipment are covered by appropriate property insurance, a warehouse bond, or other arrangements to protect PWC's interest.
 - (ii) Beginning with the second Application for Payment, each Application shall include an affidavit of Contractor stating that all previous progress payments received on account of the Work have been applied on account to discharge Contractor's legitimate obligations associated with prior Applications for Payment.
 - (iii) The amount of retainage for progress payments will be as stipulated in the Contract

Documents.

(c) Review of Applications:

- (i) Project Engineer will, within ten (10) Business Days after receipt of each Application for Payment, including each resubmittal, either indicate in writing a recommendation of payment and present the Application to PWC, or return the Application to Contractor indicating in writing Project Engineer's reason(s) for refusing to recommend payment. In the latter case, the Contractor may make the necessary corrections and resubmit the Application.
- (ii) Project Engineer's recommendation of any payment requested in an Application for Payment will constitute a representation by Project Engineer to PWC, based on Project Engineer's observations of the executed Work, and on Project Engineer's review of the Application for Payment and the accompanying data and schedules, that to the best of Project Engineer's knowledge, information, and belief:
 - 1) the Work has progressed to the point indicated;
 - 2) the quality of the Work is generally in accordance with the Contract Documents (subject to an evaluation of the Work as a functioning whole prior to or upon Substantial Completion, the results of any subsequent tests called for in the Contract Documents, a final determination of quantities and classifications for Unit Price Work, and any other qualifications stated in the recommendation); and
 - 3) the conditions precedent to Contractor's being entitled to such payment appear to have been fulfilled in so far as it is Project Engineer's responsibility to observe the Work.
- (iii) By recommending any such payment Project Engineer will not thereby be deemed to have represented that:
 - 1) inspections made to check the quality or the quantity of the Work as it has been performed have been exhaustive, extended to every aspect of the Work in progress, or involved detailed inspections of the Work beyond the responsibilities specifically assigned to Project Engineer in the Contract Documents; or
 - 2) there may not be other matters or issues between the parties that might entitle Contractor to be paid additionally by PWC or entitle PWC to withhold payment to Contractor.
- (iv) Neither Project Engineer's review of Contractor's Work for the purposes of recommending payments nor Project Engineer's recommendation of any payment, including final payment, will impose responsibility on Project Engineer:
 - 1) to supervise, direct, or control the Work, or
 - 2) for the means, methods, techniques, sequences, or procedures of construction, or the safety precautions and programs incident thereto, or
 - 3) for Contractor's failure to comply with Laws and Regulations applicable to Contractor's performance of the Work, or
 - 4) to make any examination to ascertain how or for what purposes Contractor has used the money paid on account of the Contract Price.
- (v) Project Engineer may refuse to recommend the whole or any part of any payment if, in Project Engineer's opinion, it would be incorrect to make the representations to PWC outlined in this Section.

General Conditions (Rev 7/2023)

- (d) Project Engineer will recommend reductions in payment (set-offs) necessary in Project Engineer's opinion to protect PWC from loss because:
 - (i) the Work is defective, requiring correction or replacement;
 - (ii) the Contract Price has been reduced by Change Orders;
 - (iii) PWC has been required to correct defective Work or has accepted defective Work in accordance with these General Conditions;
 - (iv) PWC has been required to remove or remediate a Hazardous Environmental Condition for which Contractor is responsible; or
 - (v) Project Engineer has actual knowledge of the occurrence of any of the events that would constitute a default by Contractor and therefore justify termination for cause under the Contract Documents.

- (e) Payment Becomes Due:
 - (i) Twenty (20) Business Days after presentation of the Application for Payment to PWC with Project Engineer's recommendation, the amount recommended (subject to any PWC set offs) will become due, and when due will be paid by PWC to Contractor.

- (f) Reductions in Payment by PWC:
 - (i) In addition to any reductions in payment (set-offs) recommended by Project Engineer, PWC is entitled to impose a set-off against payment based on any of the following:
 - 1) PWC has incurred costs, losses, or damages on account of Contractor's conduct in the performance or furnishing of the Work, including but not limited to claims, costs, losses, or damages from workplace injuries, adjacent property damage, non-compliance with Laws and Regulations, and patent infringement;
 - 2) Contractor has failed to take reasonable and customary measures to avoid damage, delay, disruption, and interference with other work at or adjacent to the Site;
 - 3) Contractor has failed to provide and maintain required bonds or insurance;
 - 4) PWC has been required to remove or remediate a Hazardous Environmental Condition for which Contractor is responsible;
 - 5) PWC has incurred extra charges or engineering costs related to submittal reviews, evaluations of proposed substitutes, tests and inspections, or return visits to manufacturing or assembly facilities;
 - 6) the Work is defective, requiring correction or replacement;
 - 7) PWC has been required to correct defective Work or has accepted defective Work in accordance with the Contract Documents;
 - 8) the Contract Price has been reduced by Change Orders;
 - 9) an event that would constitute a default by Contractor and therefore justify a termination for cause has occurred;
 - 10) liquidated damages have accrued as a result of Contractor's failure to achieve Milestones, Substantial Completion, or Completion of the Project; or
 - 11) there are other items entitling PWC to a set off against the amount recommended.
 - (ii) If PWC imposes any set-off against payment, whether based on its own knowledge or on the written recommendations of Project Engineer, PWC will give Contractor immediate written notice stating the reasons for such action and the specific amount of the reduction, and promptly pay Contractor any amount remaining after deduction of the amount so withheld. PWC shall promptly pay Contractor the amount so withheld, or any adjustment agreed to by PWC and Contractor if Contractor remedies the reasons for

General Conditions (Rev 7/2023)

such action. The reduction imposed shall be binding on Contractor unless it duly submits a Change Proposal contesting the reduction.

- (iii) Upon a subsequent determination that PWC's refusal of payment was not justified, the amount wrongfully withheld shall be treated as an amount due and subject to interest as provided in the Contract Documents.

Section 12.02 Substantial Completion

- (a) When Contractor considers the entire Work ready for its intended use Contractor shall notify PWC and Design Engineer in writing that the entire Work is substantially complete and request that PWC acknowledge in writing that Contractor has met Substantial Completion.
- (b) Promptly after Contractor's notification, PWC, Contractor, and Design Engineer shall make an inspection of the Work to determine the status of completion. If PWC does not consider the Work substantially complete, PWC will notify Contractor in writing giving the reasons therefor. PWC shall thereafter submit to Contractor an initial draft of punch list items to be completed or corrected before final payment.
- (c) If Design Engineer considers the Work substantially complete, Design Engineer will deliver to PWC a preliminary certificate of Substantial Completion which shall fix the date of Substantial Completion. Design Engineer shall attach to the certificate a punch list of items to be completed or corrected before final payment. PWC shall have seven (7) Business Days after receipt of the preliminary certificate to make written objection to Design Engineer as to any provisions of the certificate or attached punch list. If, after considering the objections to the provisions of the preliminary certificate, PWC concludes that the Work is not substantially complete, PWC will, within fourteen (14) calendar days after submission of the preliminary certificate to PWC, notify Contractor in writing that the Work is not substantially complete, stating the reasons therefor.
- (d) At the time of receipt of the preliminary certificate of Substantial Completion, PWC and Contractor will confer regarding PWC's use or occupancy of the Work following Substantial Completion, review the builder's risk insurance policy with respect to the end of the builder's risk coverage, and confirm the transition to coverage of the Work under a permanent property insurance policy held by PWC. Unless PWC and Contractor agree otherwise in writing, PWC shall bear responsibility for security, operation, protection of the Work, property insurance, maintenance, heat, and utilities upon PWC use or occupancy of the Work.
- (e) After Substantial Completion the Contractor shall promptly begin work on the punch list of items to be completed or corrected prior to final payment and shall complete such items within the time specified by PWC. In appropriate cases Contractor may submit monthly Applications for Payment for completed punch list items, following the progress payment procedures set forth above.
- (f) PWC shall have the right to exclude Contractor from the Site after the date of Substantial Completion subject to allowing Contractor reasonable access to remove its property and complete or correct items on the punch list.

Section 12.03 Partial Use or Occupancy

- (a) Prior to Substantial Completion of all the Work, PWC may use or occupy any substantially completed part of the Work which has specifically been identified in the Contract Documents, or which PWC, Design Engineer, and Contractor agree constitutes a separately functioning and usable part of the Work that can be used by PWC for its intended purpose without significant interference with Contractor's performance of the remainder of the Work, subject to the following conditions:
 - (i) At any time PWC may request in writing that Contractor permit PWC to use or occupy any such part of the Work that PWC believes to be substantially complete.
 - (ii) At any time Contractor may notify PWC and Design Engineer in writing that Contractor considers any such part of the Work substantially complete and request Design Engineer to issue a certificate of Substantial Completion for that part of the Work.
 - (iii) Within a reasonable time after either such request, PWC, Contractor, and Design Engineer shall make an inspection of that part of the Work to determine its status of completion. If Design Engineer does not consider that part of the Work to be substantially complete, Design Engineer will notify PWC and Contractor in writing giving the reasons therefor.
 - (iv) No use or occupancy or separate operation of part of the Work may occur prior to compliance with the requirements regarding builder's risk or other property insurance.

Section 12.04 Final Inspection

- (a) Upon written notice from Contractor that Completion of the Project has been achieved or an agreed portion thereof is complete, PWC will promptly make a final inspection with Project Engineer, Design Engineer, and Contractor and will notify Contractor in writing of all particulars in which this inspection reveals that the Work, or agreed portion thereof, is incomplete or defective. Contractor shall immediately take such measures as are necessary to complete such Work or remedy such deficiencies.

Section 12.05 Final Payment

- (a) Application for Payment:
 - (i) After Contractor has, in the opinion of PWC, satisfactorily completed all corrections identified during the final inspection and has delivered, in accordance with the Contract Documents, all maintenance and operating instructions, schedules, guarantees, bonds, certificates or other evidence of insurance, certificates of inspection, annotated record documents, and other documents, Contractor may make application for final payment.
 - (ii) The final Application for Payment shall be accompanied (except as previously delivered) by:
 - 1) all documentation called for in the Contract Documents;
 - 2) consent of the surety, if any, to final payment;
 - 3) satisfactory evidence that all title issues have been resolved such that title to all Work, materials, and equipment has passed to PWC free and clear or will so pass upon final payment;
 - 4) a list of all disputes that Contractor believes are unsettled; and
 - 5) complete and legally effective releases or waivers (satisfactory to PWC) required by the Contract Documents.

General Conditions (Rev 7/2023)

- (iii) If Design Engineer is satisfied that the Work has been completed and Contractor's other obligations under the Contract have been fulfilled, Design Engineer will, within ten (10) Business Days after receipt of the final Application for Payment, indicate in writing Design Engineer's recommendation of final payment and present the Application for Payment to PWC for payment. Such recommendation shall account for any set-offs against payment that are necessary in Design Engineer's opinion to protect PWC from loss for the reasons stated above with respect to progress payments. At the same time Design Engineer will also give written notice to PWC and Contractor that the Work is acceptable and that Completion of the Project has been achieved. Otherwise, Design Engineer will return the Application for Payment to Contractor, indicating in writing the reasons for refusing to recommend final payment, in which case Contractor shall make the necessary corrections and resubmit the Application for Payment.
- (iv) Within thirty (30) calendar days after the presentation to PWC of the final Application for Payment and accompanying documentation, the amount recommended by Design Engineer (less any further sum PWC is entitled to set off against Design Engineer's recommendation, including but not limited to set-offs for liquidated damages and set-offs allowed under the provisions above with respect to progress payments) will become due and shall be paid by PWC to Contractor.

Section 12.06 Waiver of Claims

- (a) The making of final payment will not constitute a waiver by PWC of claims or rights against Contractor. PWC expressly reserves claims and rights arising from defective Work appearing after final inspection, from Contractor's failure to comply with the Contract Documents or the terms of any special guarantees specified therein, from Contractor's indemnification obligations, or from Contractor's continuing obligations under the Contract Documents.
- (b) The acceptance of final payment by Contractor will constitute a waiver by Contractor of all claims and rights against PWC other than those pending matters that have been duly submitted or appealed under the provisions of the Contract Documents.

Section 12.07 Correction Period

- (a) If within one (1) year after the date of Substantial Completion (or such longer period of time as may be prescribed by the terms of any applicable special guarantee required by the Contract Documents, or by any specific provision of the Contract Documents), any Work is found to be defective, or if the repair of any damages to the Site, adjacent areas that Contractor has arranged to use through construction easements or otherwise, and other adjacent areas used by Contractor as permitted by Laws and Regulations, is found to be defective, then Contractor shall promptly, without cost to PWC and in accordance with PWC's written instructions:
 - (i) correct the defective repairs to the Site or such other adjacent areas;
 - (ii) correct such defective Work;
 - (iii) if the defective Work has been rejected by PWC, remove it from the Project and replace it with Work that is not defective, and
 - (iv) satisfactorily correct or repair or remove and replace any damage to other Work, to the work of others, or to other land or areas resulting therefrom.
- (b) If Contractor does not promptly comply with the terms of PWC's written instructions, or in an emergency where delay would cause serious risk of loss or damage, PWC may have

General Conditions (Rev 7/2023)

the defective Work corrected or repaired or may have the rejected Work removed and replaced. Contractor shall pay all claims, costs, losses, and damages (including but not limited to all fees and charges of engineers, architects, attorneys, and other professionals and all court or arbitration or other dispute resolution costs) arising out of or relating to such correction or repair or such removal and replacement (including but not limited to all costs of repair or replacement of work of others).

- (c) In special circumstances where a particular item of equipment is placed in continuous service before Substantial Completion of all the Work, the correction period for that item may start to run from an earlier date only as provided in the Contract Documents.
- (d) Where defective Work (and damage to other Work resulting therefrom) has been corrected or removed and replaced under this Article XII, the correction period hereunder with respect to such Work will be extended for an additional period of one year after such correction or removal and replacement has been satisfactorily completed.
- (e) Contractor's obligations under this Article XII are in addition to all other obligations and warranties. The provisions of this Article XII shall not be construed as a substitute for, or a waiver of, the provisions of any applicable statute of limitation or repose.

Article XIII. Suspension of Work and Termination

Section 13.01 PWC May Suspend Work

- (a) At any time and without cause, PWC may suspend the Work or any portion thereof for a period of not more than 90 consecutive calendar days by written notice to Contractor and Design Engineer. Such notice will fix the date on which Work will be resumed. Contractor shall resume the Work on the date so fixed. Contractor shall be entitled to an adjustment in the Contract Price or an extension of the Contract Times, or both, directly attributable to any such suspension. Any Change Proposal seeking such adjustments shall be submitted no later than thirty (30) calendar days after the date fixed for resumption of Work.

Section 13.02 PWC May Terminate for Cause

- (a) The occurrence of any one or more of the following events will constitute a default by Contractor and justify termination for cause:
 - (i) Contractor's continued failure to perform the Work in accordance with the Contract Documents (including, but not limited to, failure to supply sufficient skilled workers or suitable materials or equipment or failure to adhere to the Progress Schedule);
 - (ii) Failure of Contractor to perform or otherwise to comply with a material term of the Contract Documents;
 - (iii) Contractor's disregard of Laws or Regulations of any public body having jurisdiction; or
 - (iv) Contractor's repeated disregard of the authority of PWC, Project Engineer, or Design Engineer.
- (b) If one or more of the events identified in Paragraph 13.02(a) occurs, then after giving Contractor (and any surety) ten (10) calendar days written notice that PWC is considering a declaration that Contractor is in default and termination of the Agreement, PWC may proceed to:
 - (i) declare Contractor to be in default, and give Contractor (and any surety) notice that the

General Conditions (Rev 7/2023)

- Contract is terminated; and
- (ii) enforce the rights available to PWC under any applicable performance bond.
 - (c) Subject to the terms and operation of any applicable performance bond, if PWC has terminated the Contract for cause, PWC may exclude Contractor from the Site, take possession of the Work, incorporate in the Work all materials and equipment stored at the Site or for which PWC has paid Contractor but which are stored elsewhere, and complete the Work as PWC may deem expedient.
 - (d) PWC may not proceed with termination of the Contract under Paragraph 13.02(b) if Contractor within seven (7) calendar days of receipt of notice of intent to terminate begins to correct its failure to perform and proceeds diligently to cure such failure and such efforts are agreed to by PWC.
 - (e) If PWC proceeds as provided in Paragraph 13.02(b), Contractor shall not be entitled to receive any further payment until the Work is completed. If the unpaid balance of the Contract Price exceeds the cost to complete the Work, including all related claims, costs, losses, and damages (including but not limited to all fees and charges of engineers, architects, attorneys, and other professionals) sustained by PWC, such excess will be paid to Contractor. If the cost to complete the Work including such related claims, costs, losses, and damages exceeds such unpaid balance, Contractor shall pay the difference to PWC. Such claims, costs, losses, and damages incurred by PWC will be reviewed by PWC as to their reasonableness and, when so approved by PWC, incorporated in a Change Order.
 - (f) Where Contractor's services have been so terminated by PWC, the termination will not affect any rights or remedies of PWC against Contractor then existing or which may thereafter accrue, or any rights or remedies of PWC against Contractor or any surety under any payment bond or performance bond. Any retention or payment of money due Contractor by PWC will not release Contractor from liability.
 - (g) The provisions of any applicable payment or performance bond shall govern over any inconsistent provisions of this Section.

Section 13.03 PWC May Terminate For Convenience

- (a) Upon seven (7) calendar days written notice to Contractor, PWC may, without cause and without prejudice to any other right or remedy of PWC, terminate the Contract. In such case, Contractor shall be paid for (without duplication of any items):
 - (i) completed and acceptable Work executed in accordance with the Contract Documents prior to the effective date of termination, including fair and reasonable sums for overhead and profit on such Work;
 - (ii) expenses sustained prior to the effective date of termination in performing services and furnishing labor, materials, or equipment as required by the Contract Documents in connection with uncompleted Work, plus fair and reasonable sums for overhead and profit on such expenses; and
 - (iii) other reasonable expenses directly attributable to termination, including costs incurred to prepare a termination for convenience cost proposal.
- (b) Contractor shall not be paid on account of loss of anticipated overhead, profits, or revenue, or other economic loss arising out of or resulting from such termination.

Section 13.04 Contractor May Stop Work or Terminate

- (a) If, through no act or fault of Contractor, (1) the Work is suspended for more than ninety (90) consecutive calendar days by PWC or under an order of court or other public authority or (2) PWC fails for sixty (60) calendar days to pay Contractor any sum finally determined to be due, then Contractor may, upon seven (7) calendar days written notice to PWC, and provided PWC does not remedy such suspension or failure within that time, terminate the Contract and recover from PWC payment on the same terms as provided in this Article.
- (b) In lieu of terminating the Contract and without prejudice to any other right or remedy, if PWC has failed for thirty (30) calendar days to pay Contractor any sum finally determined to be due, Contractor may, seven (7) calendar days after written notice to PWC, stop the Work until payment is made of all such amounts due Contractor, including interest thereon. The provisions of this paragraph are not intended to preclude Contractor from submitting a Change Proposal for an adjustment in Contract Price or Contract Times or otherwise for expenses or damage directly attributable to Contractor's stopping the Work as permitted by this paragraph.

Section 13.05 Morality

- (a) If, in the sole opinion of PWC, at any time Contractor or any of its owner(s) or employee(s) or agent(s) (each party, owner, employee, and agent is an "Actor") engages in any one or more actions that bring disrepute, contempt, scandal, or public ridicule to the Actor or subject the Actor to prosecution or offend the community or public morals or decency or denigrate individuals or groups in the community served by PWC or are scandalous or inconsistent with community standards or good citizenship or may adversely affect PWC's finances, public standing, image, or reputation or are embarrassing or offensive to PWC or may reflect unfavorably on PWC or are derogatory or offensive to one or more employee(s) or customer(s) of PWC, PWC may immediately upon written notice to Contractor terminate the Agreement, in addition to any other rights and remedies that PWC may have pursuant to the Contract Documents or at law or in equity.

Article XIV. Miscellaneous

Section 14.01 Additional General Terms and Conditions

- (a) Contractor shall be subject to any additional terms and conditions for this Project as set forth in the applicable Appendices as specific in the Agreement, which is incorporated by reference as if set forth word-for-word herein.

Section 14.02 Giving Notice

- (a) Whenever any provision of the Contract Documents requires the giving of written notice, it will be deemed to have been validly given if:
 - (i) delivered in person, by a commercial courier service or otherwise, to the individual or to a member of the firm or to an officer of the corporation for which it is intended;
 - (ii) delivered at or sent by registered or certified mail, postage prepaid, to the last business address known to the sender of the notice; or
 - (iii) sent to PWC or Contractor's designee(s) via email, with a confirmation of receipt.

Section 14.03 Computation of Times

- (a) When any period of time is referred to in the Contract by days, it will be computed to exclude the first and include the last day of such period. If the last day of any such period falls on a Saturday or Sunday or on a day made a legal holiday by the law of the applicable jurisdiction, such day will be omitted from the computation.

Section 14.04 Cumulative Remedies

- (a) The duties and obligations imposed by these General Conditions and the rights and remedies available hereunder to the parties are in addition to, and are not to be construed in any way as a limitation of, any rights and remedies available to any or all of them which are otherwise imposed or available by Laws or Regulations, by special warranty or guarantee, or by other provisions of the Contract Documents. The provisions of this paragraph will be as effective as if repeated specifically in the Contract Documents in connection with each particular duty, obligation, right, and remedy to which they apply.

Section 14.05 Limitation of Damages

- (a) With respect to any and all Change Proposals, Claims, disputes subject to final resolution, and other matters at issue, neither PWC nor Design Engineer, nor any of their officers, directors, members, partners, employees, agents, consultants, or subcontractors, shall be liable to Contractor for any claims, costs, losses, or damages sustained by Contractor on or in connection with any other project or anticipated project.

Section 14.06 No Waiver

- (a) A party's non-enforcement of any provision shall not constitute a waiver of that provision, nor shall it affect the enforceability of that provision or any other provision of the Contract Documents.

Section 14.07 Survival of Obligations

- (a) All representations, indemnifications, warranties, and guarantees made in, required by, or given in accordance with the Contract Documents, as well as all continuing obligations indicated in the Contract Documents, will survive final payment, completion, and acceptance of the Work or termination or completion of the Agreement or termination of the services of Contractor.

Section 14.08 Controlling Law

- (a) The Agreement shall be governed by the law of the State of North Carolina.

Section 14.09 Headings

- (a) Article and paragraph headings, numbers, and letters are inserted for convenience only and do not constitute parts of these General Conditions.

SECTION C - ADMINISTRATIVE PROVISIONS

***** THIS PAGE WAS INTENTIONALLY LEFT BLANK *****

**DIVISION I
01000 – SUPPLEMENTARY CONDITIONS**

DEFINITIONS & TERMINOLOGY

1. “Owner” - Fayetteville Public Works Commission
2. “PWC Project Coordinator” - PWC employee that is observing and inspecting the Contractor’s Work onsite.

GENERAL

These Supplementary Conditions are intended to supplement and amplify the Technical Specifications and other requirements of the Contract Documents. Where any article or item of the Contract Documents is modified or deleted by this document, the remaining unaltered provisions of that article, paragraph, subparagraph, or clause shall remain in effect. In the event of a conflict, these Supplementary Conditions shall take precedence.

Unless otherwise noted, all items in these Supplementary Conditions shall be considered incidental to the Work, and no additional payment will be made for costs associated with these items.

1. ORDER OF PRECEDENCE

Except as may be otherwise specifically stated in these Contract Documents, the following order of precedence shall be adhered to for resolving any conflict, error, ambiguity, or discrepancy between the provisions of these Contract Documents:

1. Any addendum issued prior to the opening of Bids
2. The Construction Agreement, including PWC’s General Conditions
3. Section 01000 – Supplementary Conditions
4. Section 01025 – Measurement and Payment
5. Fayetteville Public Works Commission Standard Details
6. Fayetteville Public Works Commission Technical Specifications
7. Fayetteville Public Works Commission Technical Specifications

2. METHOD OF REHABILITATION

The base bid will be based upon utilizing the specified lining system. The lining system shall be installed from the invert to the ring and cover, including the bench/shelf area, and that portion of the invert above the flow line. At such time when the sewer main is under bypass (typically by others), the invert of the manhole shall also be lined.

The Contractor is advised that the presence or absence of leakage through manhole walls and/or inverts as seen in the Contractor’s independent inspection of manholes prior to bidding is dependent upon the ground water levels and conditions at the time of the inspections. The Contractor shall reflect his/her assumptions and judgments on leakage through manhole walls based on this information in the unit prices bid for lining manholes. All leakage shall be stopped prior to lining manholes. No additional payment will be made to the Contractor for repairing leaks not visible prior to bidding or sewer rehabilitation.

Repair of benches and inverts shall be incidental to the work, and no additional payment will be made. Replacement of benches and inverts shall be paid at the unit price in the Bid Form.

The Contractor shall not replace benches and inverts without approval from the PWC. All work shall be in accordance with PWC standards and as directed by the Project Engineer.

3. EXISTING CONDITIONS

Fayetteville Public Works Commission cannot guarantee that all of the manholes scheduled for rehabilitation have been inspected prior to issuing a Task Order. If the manholes have been previously inspected by the Public Works Commission, copies of those inspection reports, pictures, and/or videos will be available for viewing prior to the Contractor commencing a specific task order. The Contractor shall schedule an appointment for viewing the information.

4. CUSTOMER SERVICE

The Contractor is expected to make every effort to reduce the impact of their operation to Fayetteville Public Works Commission's operation and maintenance of the water and sewer system, and the affected customers within the project area. Full cooperation and coordination with Fayetteville Public Works Commission personnel and customers is expected. It is expected that the Contractor will promptly respond to any concerns voiced by residents and/or Fayetteville Public Works Commission personnel, and make every effort to resolve them immediately. Should the Contractor be unable to resolve the issue, the Contractor shall promptly notify Fayetteville Public Works Commission. Such notification shall include the person's name, address, nature of complaint, and the Contractor's proposed remedy. Providing exemplary customer service shall be incidental to this Contract, and no additional payment will be made for this service.

The Contractor at all times shall conduct the work in such a manner as to ensure the least obstruction to traffic practicable. The convenience of the general public and of the residents and businesses along and adjacent to the Work shall be provided for in a satisfactory manner, consistent with the operation and local conditions. The Contractor shall construct and maintain any necessary ramps, boardwalks, or other means to maintain pedestrian traffic. Costs for such work shall be incidental to the unit prices bid. The Contractor shall at all times cooperate with the public and merchants as affected by the construction operations and shall endeavor to maintain good public relations at all times.

The Contractor shall make every effort to minimize the impacts of their operation on the businesses and/or residents. The Contractor shall contact the business owners to determine the optimum time for conducting their operations. The Contractor shall schedule their operations to minimize the likelihood of equipment operating throughout the night and/or on weekends in residential areas. The Contractor shall remove their equipment from the yards of residents at the end of each work day. Equipment shall not be left in yards, overnight, or during weekends, unless the Contractor has specific written permission from the property owner.

The Contractor shall fully coordinate their operations and schedule with Fayetteville Public Works Commission.

5. CUSTOMER NOTIFICATION

Whenever the customer's use of the sanitary sewer must be interrupted by the Work, the Contractor shall notify the customers a minimum of two (2) business days in advance of the interruption. This notification shall be accomplished with door hanger notification cards placed at the addresses of the affected customers. Customers shall be informed when service interruption takes place and the expected duration. The Contractor shall make every effort to minimize inconvenience to the public and customers.

Service interruptions to customers shall be limited to no more than eight (8) hours at any given time.

The notifications shall describe the work to be undertaken and approximate dates of the work. The notifications shall clearly indicate the dates and times of the work. The text of the notifications shall be approved by Fayetteville Public Works Commission in advance. The Contractor shall notify Fayetteville Public Works Commission Project Coordinator each time such notification is issued to the customers.

6. RESIDENT NOTIFICATION OF WORK

The Contractor shall not enter back yards, fenced areas, or areas that may be deemed private or personal – regardless of easements or rights of way held by Fayetteville Public Works Commission – without consent from the property owner and Fayetteville Public Works Commission Project Coordinator. The Contractor shall coordinate with Fayetteville Public Works Commission Project Coordinator to notify residents a minimum of one (1) week in advance of the need to work in these areas.

If there are assigned areas that will require the Contractor to access areas that are deemed private or personal (regardless of easements or rights-of-way held by PWC), the Contractor shall coordinate with the PWC Design Engineer to issue letters to the affected property owners. Those notification letters will be prepared and issued by PWC. The Contractor shall coordinate with PWC so that the letters may be sent a minimum of 30 days before beginning any work in the area. The Contractor shall coordinate their schedule with PWC so that the information provided in the notification letters is as accurate as possible. Once the schedule has been established, the Contractor shall continually update PWC and the affected property owners of any changes to that schedule.

Communication and coordination with PWC and the property owners is an expectation of this Contract and will be used as a basis for determining if the Contract should be renewed. PWC prides itself on being customer oriented and it is the expectation that the Contractor will keep the customers (property owners) fully informed of their schedule.

7. WORKING TIMES

The Contractor shall limit their operations to Monday through Friday, between the times of 8:00 am and 6:00 pm, unless otherwise approved by Fayetteville Public Works Commission. The Contractor shall plan their daily activities in order to ensure that all work is completed by 6:00 pm. This provision will be strictly enforced by Fayetteville Public Works Commission.

8. CLEANLINESS DURING CONSTRUCTION

Failure of the Contractor to maintain a clean site will be basis for Fayetteville Public Works Commission to issue a written notice of non-compliance with the Contract. Should that notice to correct not be complied with within twenty-four (24) hours, Fayetteville Public Works Commission may authorize the cleanup to be performed by others and the costs shall be deducted from monies due the Contractor. The Contractor shall legally dispose off-site all waste materials and other excess materials resulting from the Work. No separate payment shall be made for maintaining a clean project site.

9. SPILL RESPONSE

The Contractor shall not discharge or pump any sewage, solids, or debris on the ground, streets, storm water system, ditches, or streams. Any sewage spills shall be immediately reported to the PWC Water Resources Construction Department, (910) 223-4716. After normal business hours, the Contractor shall contact the PWC Dispatch Center, (910) 678-7400.

In the event that raw sewage is spilled, discharged, leaked or otherwise deposited in the open environment, due to the Contractor's work, the Contractor is responsible for any cleanup of solids and disinfection of the area affected. This work will be performed at the Contractor's expense with no additional cost to the Public Works Commission. The Contractor is also responsible for complying with any and all regulatory requirements in regards to the size spill with no additional cost to the Public Works Commission. The Contractor shall cooperate fully with Fayetteville Public Works Commission and the applicable State agencies in responding to and cleaning up the spill. Any work completed by Fayetteville Public Works Commission responding to a spill caused by the Contractor's operations shall be billed to the Contractor.

Where sewage has backed up into a property due to the Contractor's failure to reopen a lateral properly or expeditiously or other aspect of the Contractor's operation, the Contractor shall immediately notify the Public Works Commission, inspect the property with Fayetteville Public Works Commission and agree on remedial measures. The Contractor shall be responsible for all cleaning, repair and / or replacement of damaged property, temporary relocation of all occupants of the affected properties, if required, all to the satisfaction of the property owner. These actions shall be undertaken immediately upon learning of the backup. Cleaning shall be performed by firms specializing in this type of work. All costs associated with the cleaning, repair, replacement of damages, occupant accommodations, insurance and spill remediation shall be borne by the Contractor. All remediation measures required as part of a spill response are part of acceptance of the project, and final payment shall not be made until such time all required measures are addressed and approved by the appropriate regulatory agency.

10. OFFICE FACILITIES

The Contractor shall provide at his expense telecommunications via cellular phone at all times on the job site. The Project Superintendent must be onsite and accessible by telephone at all times while work is progressing. The Project Superintendent shall have access to plans, contract documents, permits, and encroachment agreements at all times whether an office facility is provided by the Contractor or not.

11. PROJECT SCHEDULE

Each week, the Contractor shall provide (via email) Fayetteville Public Works Commission with their schedule for the upcoming week. The Contractor shall contact Fayetteville Public Works Commission Project Coordinator on a daily basis, to confirm their schedule for that day. The Contractor shall immediately notify Fayetteville Public Works Commission of any deviations to their schedule. Failure to notify Fayetteville Public Works Commission of any deviations may result in payment being withheld.

The schedule shall outline the work planned for each day of the week, and shall include the following information (at a minimum):

- Date
- Time (day or night)
- Manhole ID numbers
- Street name
- Map Name
- Any applicable comments

The weekly schedule can be in spreadsheet format or done in a scheduling software, such as Microsoft Project.

12. CONTRACTOR'S DUTY AND OBLIGATION TO THE PUBLIC

The Contractor at all times shall conduct the work in such a manner as to ensure the least obstruction to traffic practicable. The convenience of the general public and of the residents and businesses along and adjacent to the street(s) shall be provided for in a satisfactory manner, consistent with the operation and local conditions. The Contractor shall construct and maintain any necessary ramps, boardwalks, or other means to maintain pedestrian traffic. Costs for such work shall be incidental to the unit prices bid. The Contractor shall at all times cooperate with the public and merchants affected by the construction operations and shall maintain good public relations at all times.

The Contractor shall schedule and stage construction in a sequence to minimize disruption to the largest number of residents/businesses for the shortest period of time. Special considerations shall be given to the neighborhood solid waste and trash collection schedule, mail delivery, and bus routes, if applicable.

13. PUBLIC SAFETY

The Contractor shall barricade all work, roads, etc. to keep the public away from the construction. The Contractor shall provide protection to all portions of the Work when the work is not in progress. The Contractor shall provide and install all measures necessary to protect the public. Damage due to the lack of proper protection shall be the Contractor's sole responsibility.

The Contractor and subcontractors shall be responsible for any damage to any owner's property, private property, or property owned by other utilities. The Contractor shall repair all damage to as good as or better than existing conditions. The Contractor and subcontractors shall be responsible for and pay any claims.

14. JOBSITE REQUIREMENTS

In addition to requirements outlined in these Contract Documents, the following are mandatory requirements that will be strictly enforced:

- Posted speed limits shall be strictly adhered to. No speeding.
- Driveways shall not be blocked without prior notification and coordination with the resident.
- To the maximum extent possible, one lane of traffic shall be maintained at all times.
- Excess soil, stone, equipment, materials, etc. in the road or along the right-of-way shall be removed at the end of each workday. Soil, stone, millings, pipe, etc., shall not be stored or stockpiled in the road right-of-way.
- All trenches, excavations, or other hazards in the vicinity of the work shall be well barricaded and properly lighted at night.
- Mailboxes and traffic signs shall be only removed as necessary to facilitate the installation of the Work and shall be reinstalled during the same day of removal. Any damages to mailboxes, signs or posts shall be repaired by the Contractor at no cost to the Owner.
- Portable toilets shall be provided for workers. These facilities shall be placed discretely out of public view, kept clean, and orderly.
- Contractor(s) shall not enter onto private property for the purpose of using water or electricity without the written permission of the property owner.
- The use of profane or abusive language or obscene gesturing by workmen will not be tolerated and will be just cause for immediate dismissal from the project site as directed by the Owner or its authorized representative.
- OSHA safety measures are to be maintained at all times.
- An English-speaking Contractor's representative is required for each separate work crew.
- Do not litter at any time.
- Respond to all complaints within 24 hours.

- Wear proper protective clothing (hard hats, shoes, shirts, etc.). Personnel must wear an approved safety vest at all times while working on the Owner's project.
- During the installation of the utilities, the excavated material may be temporarily stockpiled adjacent to the work area. In no case shall stockpiled material be allowed to remain for a period of time exceeding the workday.
- The trench shall be completely backfilled at the end of each workday.
- If construction is temporarily halted during the workday, the open trench shall be manned continuously.
- Damage to sod and/or grass along the street right-of-way due to (but not limited to) temporarily stockpiled material, construction travel and other construction related activities shall be replaced with sod at the Contractor's sole expense.

15. SUBCONTRACTORS

The proposed lining method shall be completed by the prime contractor utilizing its own equipment and labor forces. The lining superintendent shall be an employee of the prime contractor.

Second tier subcontractors shall not be allowed. Violation of this provision of the Contract may be deemed a breach of the Contract.

16. STORED MATERIALS

There will be no payment for stored materials on this project.

17. GUARANTEE

All work completed under these Contract Documents shall be guaranteed by the Contractor for a period of five (5) years from the date of final acceptance. During that period, all serious defects discovered in the work, as determined by Fayetteville Public Works Commission, shall be removed and replaced in a satisfactory manner by the Contractor at no cost to Fayetteville Public Works Commission. Fayetteville Public Works Commission may conduct an independent television inspection, at their sole expense, of the lining work prior to the completion of the five (5) year guarantee period.

Should Fayetteville Public Works Commission's inspection determine that the liner is not in accordance with these Contract Documents; the Contractor shall mobilize and make all necessary repairs (including bypass, access, etc.) at no expense to Fayetteville Public Works Commission. The Contractor will receive written notification from Fayetteville Public Works Commission and be allowed the chance to review the inspection documentation. The Contractor shall respond to Fayetteville Public Works Commission with a plan of action within 30 calendar days of receiving notification. Alternatively, Fayetteville Public Works Commission reserves the right to contract with another party to complete the warranty work, at the sole expense of the Contractor.

18. INSPECTION

Inspection of the liner may be made by Fayetteville Public Works Commission, or their authorized representative, at any time after delivery. The liner shall be subject to rejection at any time on account of failure to meet any of the requirements specified, even though the sample liner may have been accepted as satisfactory at the place of manufacture. Liner rejected after delivery shall be marked for identification and promptly removed from the jobsite.

19. PRE-CONSTRUCTION VIDEO

The Contractor shall complete a pre-construction video inspection of the project area, to document pre-existing conditions. The video shall be submitted to Fayetteville Public

Works Commission on a standard portable digital media as outlined in these Contract Documents. The intent of this video is to document the roadside and/or easement conditions, easement

areas, the driveways, the condition of the curb and gutter, the condition of the mailboxes, retaining walls, fences and gates, any other resident installed improvements, and the condition of the sod. The Contractor shall include any easement areas, especially those passing through yards, driveways, etc. The video must identify the house number and the street name in the audio track and visually. The Contractor may also include any pre-existing conditions they want brought to the attention of Fayetteville Public Works Commission Project Engineer by including notes and time position on the index sheet. The Contractor can also include still pictures of the areas, for additional documentation. The video and any other accompanying data shall be submitted to Fayetteville Public Works Commission Project Engineer before any work can commence. The Contractor shall furnish copies of the video inspection in a standard digital video file format (mp4 or avi) and on a standard portable digital media (USB Flash Drive or USB Hard Disk Drive) Fayetteville Public Works Commission

20. LIMITS OF CONSTRUCTION

The Contractor shall confine their rehabilitation operations (bypass, access, etc.) to the existing permanent easement (typically 20 feet, centered on the sewer main) or the existing street rights-of-way. The Contractor shall coordinate with Fayetteville Public Works Commission to confirm the size and location of the existing permanent easement(s).

The Contractor may use additional area for staging, storage or other operations, provided that written permission is obtained from the property owner and all disturbed areas are restored to conditions equal to or better than existing.

21. STAGING AREAS

The Contractor shall be required to secure staging areas for storing materials, equipment, etc. All costs, such as rent, restoration, erosion control measures, and permit fees shall be the responsibility of the Contractor. The location and operation of the staging yard shall comply with all applicable Federal, State, and local regulations.

All staging areas will be subject to inspection by Fayetteville Public Works Commission, or agents thereof, for compliance with this section without prior notice. Any deficiencies will be documented by Fayetteville Public Works Commission and written notice will be given to the Contractor in accordance with these Contract Documents. The Contractor shall rectify any deficiencies in a reasonable time frame. Failure to do so will result in breach of contract.

The Contractor will submit a Staging Area Operation Plan for each site consisting at a minimum of the following:

- The layout of each staging area clearly identifying use areas and sufficient in detail and scale to indicate the proximity of activity to adjacent residences and businesses;
- Transportation plan including routes for both ingress and egress;
- Dust control measures both on site and along transportation routes necessary to minimize the transmission of material onto streets used for ingress and egress;
- Fuel and hazardous material storage and management. Total secondary containment, shall be used for fuel and liquid hazardous materials storage and to prevent spillage.
- Hours of operation and noise mitigation measures.
- Application and Fee for the Temporary Use Permit.
- Application and Fee for Truck Route Permit.

The Contractor shall obtain a signed agreement for the staging area in accordance with the PWC General Conditions of these Contract Documents. Upon the completion of the project the Contractor shall obtain a signed release from the property owner for the satisfactory completion and restoration prior to issuance of final payment.

22. AGREEMENTS WITH PROPERTY OWNERS

Any and all agreements between the Contractor and individual property owners for work (to included access for bypass pumping and/or piping), services, rent of staging areas, etc. located outside of any easements or public rights-of way shall not obligate the City of Fayetteville or Fayetteville Public Works Commission in any manner. Prior to performing any work on private property, which could remotely infer the Contractor acting on behalf of Fayetteville Public Works Commission, the Contractor shall furnish to Fayetteville Public Works Commission a signed and witnessed statement executed by the property owner acknowledging that the City of Fayetteville and Fayetteville Public Works Commission are not liable for any agreements between the property owner and the Contractor, and that the Contractor shall hold harmless and defend the City of Fayetteville and Fayetteville Public Works Commission from all claims, damages, etc. Additionally, all agreements/actions by Subcontractors shall be the Contractor's responsibility to secure the property owner's agreement as described herein.

Prior to release of final payment, the Contractor shall obtain written releases from the property owners for satisfaction, completion, and restoration. Copies of those written releases shall be submitted to Fayetteville Public Works Commission with the final pay application.

The Contractor bears complete responsibility for any damage to private properties outside of the permanent easements and/or rights-of-way.

23. ACCESS

Fayetteville Public Works Commission's sewer system spans a wide variety of terrain and soil conditions. Groundwater and soil conditions can vary from manhole to manhole (within streets and/or neighborhoods), area to area, and can vary depending on the season, and the amount of rainfall. Many sewer manholes that are in need of rehabilitation are located in easement areas, where it may not be possible to drive a vehicle to the manhole. Some manholes may be located more than 500 feet from vehicle access. Additionally, many of the easement areas are in low-lying areas, with high groundwater tables and/or standing water. Contractors may need to cross streams, railroad tracks, and other obstacles (both natural and man-made) to access the assigned manholes.

The Contractor shall be responsible for constructing the necessary access needed to complete the project as outlined in these Contract Documents. The Contractor shall confine their access requirements to public rights-of-way or permanent easements, wherever possible. Fayetteville Public Works Commission will provide assistance in attempting to gain permission to cross private property, in the event it is necessary. The Contractor shall coordinate with Fayetteville Public Works Commission a minimum of two (2) weeks in advance, in order to gain such access.

Prior to completing any work on private property that is outside of a permanent easement, the Contractor shall obtain an agreement with that property owner. Further, the Contractor shall complete a pre-construction video inspection of the property. It is recommended that the pre-construction video document existing conditions of the areas adjacent to the proposed work area.

All access that is constructed on private property shall be removed and the property restored to existing or better condition than before construction commenced. The Contractor shall be responsible for obtaining a signed release from the affected property owner(s), stating that the property has been satisfactorily restored. Final payment shall not be released until all signed releases are obtained and submitted to Fayetteville Public Works Commission.

Access constructed in permanent easements shall remain, unless otherwise instructed by Fayetteville Public Works Commission.

Fayetteville Public Works Commission shall be responsible for clearing the existing permanent easement right-of-way, should it be necessary. The Contractor shall provide Fayetteville Public Works Commission with a minimum of two (2) weeks notice for any easement clearing.

24. GATE ACCESS

Fayetteville Public Works Commission has several locations where gates and fences have been installed across permanent utility easements. The Contractor may utilize the gate(s) for access to the proposed sanitary sewer manholes to be rehabilitated. The Contractor shall furnish their lock to facilitate access. The Contractor shall inter-lock their lock with Fayetteville Public Works Commission lock, to ensure that either can gain access to the easement without the other being present. The gate shall be locked at the end of each workday, or whenever there is no activity in that area. The Contractor shall coordinate with the PWC Project Coordinator for inter-locking any gate(s). The Contractor shall remove their lock upon completion of the work.

25. MANHOLE COVERS

For all manholes in streets, the Contractor shall secure the covers to the rings to reduce rattling. The Contractor shall apply four (4) dollops of roofing tar to the frame, to eliminate the cover from rattling. The dollops shall be equally spaced around the frame to the ring utilizing four dollops approximately the size of a quarter, each spaced 90 degrees around the ring. The roofing tar shall be applied upon completion of the pre-rehabilitation cleaning and video inspection, as well as upon completion of the post-rehabilitation inspection. Fayetteville Public Works Commission Project Coordinator shall verify that the manholes are properly sealed and do not rattle. The cost for this work is considered incidental, and no separate payment will be made.

For manholes located in easement areas, the Contractor shall secure the covers at all times. For those manholes that are water-tight with a locking ring and cover (cam-lock), those manholes shall be locked whenever the Contractor leaves that particular manhole. **In no circumstance shall a manhole cover be left uncovered and/or unlocked when the Contractor leaves the site.**

Contractors shall ensure that their subcontractors are aware of and in compliance with these requirements.

This provision will be strictly enforced by Fayetteville Public Works Commission.

In the event that a manhole cover does not seat and/or lock properly, the Contractor shall immediately notify Fayetteville Public Works Commission Project Coordinator.

26. COORDINATION WITH OTHER REHABILITATION CONTRACTOR(S)

Occasionally, Fayetteville Public Works Commission will assign sewer mains and/or sewer laterals to be rehabilitated that are on the same section of sewer mains that are being rehabilitated by the manhole rehabilitation contractor. In most cases, these are larger diameter

mains, and are typically placed on a temporary bypass system in order to rehabilitate the mains. The Contractor shall coordinate their operations and schedule with PWC and the sewer main and/or sewer lateral rehabilitation contractor(s), in order to minimize the amount of time the temporary bypass system is running, and not delay the sewer main and/or sewer lateral rehabilitation contractor(s) from completing their work (e.g., constructing access, cleaning, inspection, etc.) in a timely manner.

The Contractor shall complete all preparation of the manholes prior to the sewer mains being cleaned and rehabilitated. The Contractor shall be responsible for stopping any infiltration entering the manhole from the area between the host sewer main and the sewer main liner. It is noted that the sewer main rehabilitation contractor will be required to install end seals prior to rehabilitating the sewer main, in order to minimize the amount of infiltration.

The Contractor shall be responsible for repairing any damage to the manhole resulting from the sewer main rehabilitation work. Any manhole rehabilitation work that is completed prior to the sewer main rehabilitation will not be tested. PWC will test and accept the manholes upon completion of the sewer main rehabilitation, and after any necessary repairs have been made.

27. PROTECTION OF SANITARY SEWER SYSTEM

The Contractor shall take all necessary precaution to guard against any or all damage to existing structures, pipe lines, and equipment of Fayetteville Public Works Commission. Any damage to existing structures, pipe lines, or equipment resulting from the Contractor's operations shall be the Contractor's responsibility to repair/replace prior to proceeding with the rehabilitation work. All repairs shall be in accordance with Fayetteville Public Works Commission standards.

The Contractor shall prevent debris and other items from their rehabilitation efforts from entering the sewer system. Damage to Fayetteville Public Works Commission facilities resulting from the Contractor's failure to control debris and/or other items related to their operation shall be the sole responsibility of the Contractor.

In the event any debris or other item from their operation enters the sewer system, the Contractor shall ***immediately*** contact Fayetteville Public Works Commission. The Contractor shall then commence efforts to capture that debris at the downstream manholes. The Contractor shall continue to search for and recover any debris until either all debris is captured or instructed otherwise by Fayetteville Public Works Commission. Any costs incurred by Fayetteville Public Works Commission to help search for and/or retrieve the debris shall be the responsibility of the Contractor.

28. DAMAGE TO EXISTING UTILITIES

The Contractor shall take every precaution to guard against any damage to existing structures, pipelines, and/or equipment of the utility owner. Any damage to existing structures and/or pipelines shall be the direct responsibility of the Contractor. Damage shall be replaced and/or repaired by the Contractor as directed by the utility owner, or the value of such deducted from any monies due the Contractor under this Contract.

The utility owner shall supervise the Contractor's operation of all valves, gates, and other equipment. Except in case of emergency, the Contractor shall notify the utility owner a minimum of two (2) business days in advance of the need for operation of valves, gates, and other equipment necessary to allow the work to progress.

The Contractor shall notify the utility owner and the PWC Project Coordinator a minimum of 48 hours in advance to coordinate any proposed service interruption. If an unscheduled service interruption occurs, the Contractor shall immediately notify the utility owner and the

PWC Project Coordinator. The Contractor shall immediately commence repairs in accordance with the utility owner's standards.

29. SANITARY SEWER FLOW MONITORS

Fayetteville Public Works Commission maintains a network of 44 permanent flow monitors within the sanitary sewer system. In addition to the permanent flow monitors, Fayetteville Public Works Commission may have several temporary flow monitors installed in various areas of the sanitary sewer system. In the event the Contractor encounters this equipment, they shall immediately contact Fayetteville Public Works Commission Project Coordinator. Fayetteville Public Works Commission will be responsible for the removal and reinstallation of the flow monitor equipment. Any damage to the flow monitor equipment resulting from the Contractor's operation shall be the responsibility of the Contractor.

30. LIFT STATION OPERATIONS

There may be several sewer manholes included in this Contract that receive force main discharges. The Contractor shall visit those manholes to verify the need for any coordination regarding operation of the lift station. Any concerns regarding lift station operations and the ability to complete the work as described in these Contract Documents shall be discussed with Fayetteville Public Works Commission a minimum of two (2) weeks prior to commencing work on those manholes. Fayetteville Public Works Commission and Contractor shall coordinate as necessary to operate the lift stations so that the Contractor can complete the rehabilitation work.

31. REPLACEMENT OF FENCING

The Contractor is to replace any fencing disturbed as part of their operations for the work described within these Contract Documents. Fence re-setting is considered incidental to the operation, and no additional payment will be made for this work. In addition, if temporary fencing is requested by a property owner, the Contractor shall provide such fencing as necessary, at no additional cost to Fayetteville Public Works Commission. Fences shall be removed, properly stored and replaced, using new items as required, to restore the item to the original condition or better.

It is noted that private fences may be located across or on the utility easement. It is expected that the Contractor will fully scope the proposed project area(s) prior to commencing work, in order to conduct the work with minimal disruption and fence removal. The Contractor shall have the primary responsibility to coordinate access across private property.

32. EROSION AND SEDIMENTATION CONTROL

The provisions of Chapter 139, North Carolina General Statutes, as amended, shall be applicable to this project. The Contractor shall progressively adjust and/or add erosion control measures to complement their type of construction to prevent erosion and the transmittal of silt. All necessary erosion control measures shall be installed prior to any work. The installed erosion control measures shall remain serviceable until the site is restored and stabilized. Upon such time (which may be after completion of the project), the Contractor shall remove all temporary measures.

All fees, penalties, fines for non-compliance and all civil actions resulting there from shall be the Contractor's responsibility and shall in no way involve Fayetteville Public Works Commission. The Contractor shall immediately notify Fayetteville Public Works Commission of any fine, penalty, or notice of non-compliance by the North Carolina Department of Environmental Quality (NCDEQ). The Contractor may be required to modify or supplement the measures at no additional cost to Fayetteville Public Works Commission.

In addition to installing and maintaining the appropriate erosion control devices, the Contractor shall maintain a neat and clean jobsite. The Contractor shall take the necessary measures to minimize dust, ensure the streets are clean and free of debris, and other measures as required. The Contractor shall maintain the proper erosion control devices to ensure against erosion. The Contractor shall ensure that the catch basin and inlet protection devices are free of dirt and debris.

Permanent and temporary erosion control measures proposed by the Contractor for staging areas, haul roads, bypass lines, etc. shall be at the Contractor's expense and shall not constitute additional compensation.

33. RAILROAD ENCROACHMENT

Future work for this project may be within the rights-of-way of the various railroad companies in Cumberland County. The railroad companies in Cumberland County are as follows: CSX Transportation, Inc., Norfolk Southern Railway, and Aberdeen & Rockfish Railroad Company. No work shall be undertaken within the railroad rights-of-way until an encroachment agreement has been approved. Fayetteville Public Works Commission will make the submission to the necessary Railroad Company for any encroachments. It is anticipated that a provision of the encroachment will be for the Contractor to furnish proof of Railroad Protective Liability (RPL) insurance.

Fayetteville Public Works Commission will be responsible for submitting any encroachments to the Railroad Companies. The encroachment package cannot be submitted until the Contractor submits their certificate of RPL insurance coverage. The Contractor shall submit the entire original policy or binder with endorsement as proof of RPL to Fayetteville Public Works Commission. Failure to submit the required insurance in a timely manner shall not be the basis for any extensions of Contract Time. Fayetteville Public Works Commission will reimburse the Contractor for the cost of the RPL insurance, based on the actual invoice from the Contractor's insurance provider. Fayetteville Public Works Commission will not pay for any mark-up to the cost of the insurance.

The following are the anticipated insurance requirements for CSX Transportation:

- RPL - \$5,000,000 per occurrence and \$10,000,000 aggregate
- Statutory Worker's Compensation – not less than \$1,000,000
- Commercial General Liability – not less than \$5,000,000 and name CSX Transportation as an additional insured
- Business Automotive Liability – not less than \$1,000,000 combined single limit.

The following are the anticipated insurance requirements for Norfolk Southern Railway:

- RPL - \$2,000,000 per occurrence and \$6,000,000 aggregate
- Commercial General Liability – not less than \$1,000,000 and name Norfolk Southern Railway as an additional insured

The following are the anticipated insurance requirements for Aberdeen & Rockfish Railroad:

- RPL - \$2,000,000 per occurrence and \$6,000,000 aggregate
- Commercial General Liability – not less than \$2,000,000 and name Aberdeen & Rockfish Railroad Company as an additional insured.

It is anticipated that the Railroad Company will require a flagger to be present during **all** operations within the railroad rights-of-way, to include cleaning and preparation, application of the lining system, replacement of rings and covers, etc. The Contractor shall be responsible

for coordinating with Fayetteville Public Works Commission and Railroad Company to ensure that a flagger is present for all operations within the railroad rights-of-way.

The Contractor shall coordinate their proposed work with Fayetteville Public Works Commission, in order to get a flagger scheduled. Bidders are hereby notified that scheduling a flagger could take 30 calendar days or more, depending on the Railroad Company's schedule. Therefore, the Contractor shall notify Fayetteville Public Works Commission in a timely manner to schedule a flagger, so as not to delay the project. Failure of the Contractor to properly coordinate their schedule with Fayetteville Public Works Commission shall not be the basis for any extensions of Contract Time or additional compensation. Once the flagger has been scheduled by Fayetteville Public Works Commission, the Contractor shall adjust their operations as necessary to minimize the amount of time working within the railroad rights-of-way. Further, the Contractor shall adjust their operations to accommodate the schedule of the flagger, at no additional cost to Fayetteville Public Works Commission.

Fayetteville Public Works Commission shall be responsible for payment to Railroad Company for the flagging operation.

34. EQUIPMENT

The Contractor shall be equipped with equipment perfectly adaptable for the type of construction required; spray equipment shall be of sufficient capacity to handle the work in an expeditious and safe manner. Fayetteville Public Works Commission reserves the right to deny the use of inadequate equipment or of equipment not capable of performing the work in an acceptable manner.

With respect to the foregoing, it is the intent of Fayetteville Public Works Commission to require that the Contractor be equipped to perform the work shown and specified, expeditiously and in accordance with the best modern practice.

35. SITE RESTORATION AND CLEANUP

Upon completion of a section of work, the project location shall be cleaned up and grounds restored to the conditions that existed prior to commencing work. All restoration work shall be completed prior to commencing another section of work. Restoration includes, but is not limited to, seeding, mulching, placement of sod, replacement of fences, and patch paving.

In those areas where an established stand of grass is disturbed due to the construction activities, the Contractor shall restore that area with sod. All other non-paved areas shall be seeded and mulched.

Surplus material, tools, and temporary structures shall be removed by the Contractor. All dirt, rubbish, and other debris from the operation shall be removed and legally disposed of by the Contractor, at no additional cost to the PWC.

The Contractor is to replace any fencing disturbed as part of their operations. Replacement of fencing is considered incidental to the operation, and no additional payment will be made for this work. In addition, if temporary fencing is required, the Contractor shall provide such fencing as necessary, at no additional cost to the PWC. Fences shall be removed and replaced, using new materials as required, to restore the item to the original condition or better.

36. EXISTING CONDITIONS

Fayetteville Public Works Commission cannot guarantee that all of the sewer manholes scheduled for rehabilitation have been cleaned and/or inspected prior to assigning them to the Contractor.

37. TRAFFIC CONTROL

Traffic control measures shall be in accordance with Specification Section 02500 – Traffic Control, and the following requirements. The Contractor shall provide any and all traffic safety measures as required to satisfy local, state, and federal highway requirements. The Contractor working in public rights-of-way on streets open to vehicular traffic shall be required to temporarily maintain traffic control devices to reduce unnecessary congestion and unsafe traffic conditions.

The Contractor shall be liable for any damages resulting from his negligence in using adequate work zone traffic control. Furthermore, Fayetteville Public Works Commission reserves the right to stop any work for non-compliance.

The Contractor shall coordinate his activities so as to minimize disruption of traffic and inconvenience to residents and the general public. All such traffic control devices, traffic patterns and road closures shall be approved by the Town of Hope Mills, the City of Fayetteville and/or NCDOT.

The point of contact for the City of Fayetteville, NCDOT, and the Town of Hope Mills are:

Ramon Melendez (City): (910) 433-1090

Troy Baker (NCDOT): (910) 364-0601

Ira Petersen (Hope Mills): (910) 429-3383

Failure to provide and maintain adequate traffic control devices may result in Fayetteville Public Works Commission's refusal to make payment until corrective measures are in place.

Improper signage and traffic control devices will not be allowed. The City of Fayetteville, NCDOT, the Town of Hope Mills, and/or Fayetteville Public Works Commission reserves the right relocate and/or remove such non-conforming signs and devices, setup proper signage to ensure public safety and deduct all costs for these items which may be incurred by Fayetteville Public Works Commission. The Contractor shall make no claim for such work performed.

No work on the individual streets shall start until all the traffic control devices required for the particular work activity have been installed in accordance with the approved traffic control plan.

38. CONFINED SPACE

Prior to entering manholes or other areas that are defined as confined spaces, the Contractor shall follow all requirements and procedures as outlined by the Occupational Safety and Health Administration's (OSHA) Confined Space Entry requirements. A confined space entry program shall be included as part of the Contractor's Safety Plan.

39. CHEMICAL USES

All constituents of concern used during project construction or furnished for project operation, whether herbicides, pesticides, disinfectant, polymer, reactant or of other classification, must show approval of either the Environmental Protection Agency or the USDA. Use of all such chemical and disposal of residues shall be in strict conformance with manufacturer's instructions.

40. HAZARDOUS COMMUNICATION PROGRAMS

Refer to Article 5, Paragraph 5.05 in PWC General Conditions.

The Contractor shall be responsible to provide and maintain SDS sheets at the job site at all times. The sheets shall be located in an easily accessible and prominently located area. If

the Contractor encounters any materials considered or suspected of being hazardous, the Contractor shall immediately secure the area and contact the Project Engineer for further instructions.

41. DISPOSAL OF DEBRIS

Debris collected by the Contractor's cleaning efforts can be disposed of at Fayetteville Public Works Commission's Rockfish Creek Water Reclamation Facility (WRF). Fayetteville Public Works Commission will be responsible for the debris once it is received at the Rockfish Creek WRF. The Rockfish Creek WRF is located at the end of Tracy Hall Road, near the intersection of Old Wilmington Road and NC Highway 87. The Contractor shall bear all costs for transporting the debris to the disposal site.

The Contractor shall take all necessary precautions to prevent debris and other items related to their rehabilitation efforts from entering the sewer system.

42. EXCAVATION

The Contractor shall be responsible for utilizing all measures necessary to comply with the applicable OSHA regulations.

Prior to excavation, the Contractor shall sawcut and remove asphalt or concrete pavement within the limits of allowable trench width. Where the excavation is within grassed easement areas, the Contractor shall take care to minimize disturbance and/or removal of trees, shrubs, bushes, etc.

43. PROTECTION OF PROPERTY

Upon request from the property owner, the Contractor shall remove and set aside those plantings identified by the property owner. All plantings to be salvaged shall be placed at the edge of the existing easement. It will be the property owner's responsibility to re-plant those items saved.

Tree branches and ornamental shrubbery shall be temporarily tied back to avoid damage. Damage to trees shall be trimmed and treated with a tree dressing.

44. MONTHLY PROGRESS MEETINGS

The Contractor and Fayetteville Public Works Commission Project Engineer shall mutually establish a regular time to meet on a monthly basis, for the duration of the project. The meetings shall be held at Fayetteville Public Works Commission complex at 955 Old Wilmington Road, and will generally last about an hour. The Contractor's superintendent or designated representative shall attend these meetings. The Contractor's representative shall be knowledgeable of the project, issues that need to be addressed, and be able to make binding decisions for the Contractor.

The purpose of the meeting is to discuss various project related items, including, but not limited to: safety concerns, overall project status and schedule, the Contractor's schedule for the upcoming month, issues that the Contractor and/or Fayetteville Public Works Commission Project Engineer need to address, viewing of pre and/or post lining videos, and any proposed or potential change orders.

The cost for the Contractor's representative to attend the monthly meetings shall be included in the unit prices bid.

45. BULK WATER USAGE

Fayetteville Public Works Commission will allow the Contractor to use water from its existing water system. The Contractor shall utilize proper backflow prevention devices when obtaining

water from Fayetteville Public Works Commission's system. The Contractor shall contact Fayetteville Public Works Commission's Environmental System Protection Department at 910-223-4699 to determine the required backflow prevention devices, and to obtain a bulk water permit. The bulk water permit is an annual permit, and must be kept current throughout the duration of this Contract. The Contractor shall be responsible for the annual permit fee. The Contractor shall provide documentation on the amount of water used for their operations, and provide a monthly statement to Fayetteville Public Works Commission.

46. DOCUMENTATION

Upon completion of each manhole, the Contractor shall test and visually inspect the completed manhole. Any and all defects noted shall be corrected prior to scheduling a final inspection and test with the Public Works Commission. Upon completion of the Public Works Commission's inspection and testing, an inspection report for each manhole shall be completed by the Public Works Commission. The report shall note the date and time, the manhole facility identification number, and the test results. Any failures or defects will be noted. The Contractor shall initial each report, to indicate concurrence with the results. Copies of the inspection report can be provided to the Contractor, upon request.

Additionally, the Contractor shall furnish Fayetteville Public Works Commission digital photographs of the completed manhole. The photographs shall include the date, and the facility identification number. The photographs shall depict the following, for each manhole:

- The ring and cover, showing the lining at the ring and cover
- The completed shelf and invert
- The manhole walls
- The immediate area around the manhole, indicating that the area is properly restored

At least one of the above pictures shall include a note card or other method of documenting the facility identification number of the manhole. Photographs of only the note card indicating the facility identification number will not be acceptable.

Photographs shall be stored on a USB Flash Drive or USB Hard Disk Drive and submitted to Fayetteville Public Works Commission with the final pay request.

47. EMERGENCY RESPONSE

In the event an emergency occurs, the Contractor shall immediately notify Fayetteville Public Works Commission's Project Coordinator and Project Engineer, and immediately commence repairs. If the Contractor is unable to contact Fayetteville Public Works Commission's Project Coordinator and Project Engineer, the Contractor shall immediately contact Fayetteville Public Works Commission Dispatcher (910-678-7400).

The Contractor shall have personnel available to respond and perform emergency work immediately. It is the Contractor's responsibility to immediately respond to any emergency. The Contractor shall immediately notify Fayetteville Public Works Commission if their crews are unable to perform the emergency work or if assistance will be required from Fayetteville Public Works Commission. Any work completed by Fayetteville Public Works Commission may be billed to the Contractor.

The Contractor shall maintain a crew capable of performing emergency maintenance work 24 hours a day, seven (7) days a week, including all holidays. The Contractor shall provide phone numbers for at least three (3) individuals in responsible charge (capable of making company binding decisions) to be available 24 hours a day, seven (7) days a week, including holidays. The emergency phone numbers and responsible individual's names shall be furnished to Fayetteville Public Works Commission.

48. SUBMITTALS

The Contractor shall not perform any portion of the Work requiring submittal and review until the respective submittal has been approved by Fayetteville Public Works Commission. Work performed prior to review and acceptance shall be at the Contractor's risk.

The Contractor shall submit the following information to Fayetteville Public Works Commission prior to commencing the first section of work. Unless the Contractor proposes to install a different type of lining system, changes the installation process or deviates in any way from the initial submission, submittals are not required prior to starting work on each task order.

The Contractor shall provide submittals, in accordance with the PWC General Conditions, on but not limited to the following:

- A sample door hanger, notifying the residents of the project and those times that the resident may not have sewer service
- Details (specifications, SDS, lining materials, etc.) on the proposed lining materials to be used (including patching material, cement basecoat material, and lining material)
- Specific installation procedures
- Proposed supplier and list of materials to be used
- Certified test reports that the proposed materials for this Contract were manufactured and tested in accordance with the specified American Society for Testing Materials (ASTM)
- Contractor's safety plan, including confined space program
- Certification of the lining operator and project supervisor
- Certification that the proposed lining equipment has been approved by the lining manufacturer
- Certification that the contractor have been trained for use on the proposed lining equipment
- Proposed project schedule
- Labor and equipment rates
- Contractor personnel emergency contact information

The Contractor shall provide submittals on all lining materials and shall furnish the manufacturers' certifications that all of the lining materials are in compliance with the specifications, codes, and standards referenced in these Contract Documents. The submittals shall include installation instructions and details of all component materials and construction methods.

All information contained within the submittals shall be in accordance with these Contract Documents. Facsimile (fax) copies of the submittals or re-submittals will not be acceptable.

49. RESIDENTIAL/COMMERCIAL COMPLAINTS

Fayetteville Public Works Commission' Complaint Resolution Procedure shall be followed throughout the duration of the Contract. The Contractor is required to maintain good public relations and to provide timely notifications to residents so as to minimize inconvenience and complaints.

Fayetteville Public Works Commission has an established protocol for addressing residents' complaints. The Contractor shall be responsible for familiarizing himself and his subcontractors with this protocol. During the course of the Work, the Contractor shall immediately respond to requests from Fayetteville Public Works Commission to address resident complaints. The Contractor shall inform his personnel and subcontractor personnel that all complaint issues be directed to Fayetteville Public Works Commission Project

Coordinator and the Contractor's Superintendent. Fayetteville Public Works Commission Project Coordinator shall be present in all meetings with residents. Should Fayetteville Public Works Commission determine the Contractor(s) non-responsive in addressing complaints, Fayetteville Public Works Commission reserves the right to withhold progress payments until the complaint has been satisfied. The Contractor shall immediately notify Fayetteville Public Works Commission Project Coordinator of any complaint received.

50. CONTRACTOR CLAIMS FOR EXTRA COST

Should the Contractor consider that as a result of any instructions given in writing by Fayetteville Public Works Commission Project Engineer, he is entitled to extra costs above that stated in the Contract; the Contractor shall give written notice to Fayetteville Public Works Commission Project Engineer. The written notice shall be sent to Fayetteville Public Works Commission Project Engineer within seven (7) calendar days after the occurrence of the event and the Contractor shall not proceed with the work affected until further advised, except in an emergency involving the safety of life or property. No claims for extra compensation will be considered unless the claim is made. Extra Work performed by the Contractor, not approved by Fayetteville Public Works Commission Project Engineer in writing shall not be considered for payment.

The Contractor shall not act on instructions received by him from persons other than Fayetteville Public Works Commission's Project Engineer and/or Project Coordinator. Any claims for extra compensation or extension of time on account of unauthorized instruction will not be honored. Fayetteville Public Works Commission Project Engineer will not be responsible for misunderstandings claimed by the Contractor of verbal instructions which have not been confirmed in writing, and in no such case shall instructions be interpreted as permitting a departure from the Contract Documents unless such instruction is confirmed in writing by Fayetteville Public Works Commission Project Engineer.

51. TESTING

All testing shall be in accordance with PWC standards and upon completion of each manhole, the Contractor shall test and visually inspect the completed manhole. Any and all defects noted shall be corrected prior to scheduling a final inspection and test with PWC. An inspection report for each manhole shall be completed by the PWC Project Coordinator. The report shall note the date and time, the manhole facility identification number, and the test results. The Contractor shall initial each report, to indicate concurrence with the results. Copies of the inspection report will be provided to the Contractor.

52. FINAL INSPECTION/ACCEPTANCE OF WORK

When Fayetteville Public Works Commission Project Coordinator deems the project completed and ready for final inspection, Fayetteville Public Works Commission Project Coordinator shall notify Fayetteville Public Works Commission Project Engineer. During the final inspection any items documented shall be compiled in a final punch list and provided to the Contractor within five (5) business days. The Contractor shall be required to complete each item in the final inspection punch list within 30 calendar days of receipt. The project will not be considered complete until all punch list items are completed and accepted, unless otherwise determined by Fayetteville Public Works Commission Project Engineer. All punch list items shall be completed prior to release of final payment.

Prior to the final inspection, the Contractor shall complete the following:

- All manholes having camlock ring and covers shall be locked.

- Place a Fayetteville Public Works Commission issued marker at all valves, manholes, and air release valve manholes outside of pavement as directed by Fayetteville Public Works Commission Project Coordinator.
- Verify all plugs have been removed.
- Complete all restoration.
- Complete all required testing.

No separate payment shall be made for this work.

Final Completion Documentation

Prior to receiving final payment, the Contractor shall complete and/or provide the following:

- Complete all punch list items to the satisfaction of Fayetteville Public Works Commission Project Engineer.
- Satisfactorily resolve all customer complaints and obtain the required releases.
- Project record drawings, in accordance with Submittals Section 01300; and
- Project close-out submittals in accordance with Submittals Section 01300.

*** END OF SECTION ***

**DIVISION 1
01025 – MEASUREMENT AND PAYMENT**

GENERAL

This section defines the methods of measurement and payment for each of the prices listed in the Bid, which are required to complete the work. The bid price shall be full compensation for the work required under each bid item, which shall include all incidental costs relative thereto. Certain items of work are specified and/or shown as a detail in the Contract Documents. Bid prices shall include all items of work required to furnish and/or install each in accordance with the Project requirements, whether specifically stated or itemized in the Measurement and Payment description.

Each unit price for the specific line item shall include coordination with PWC personnel, all materials, labor, and incidentals associated with the specific item of work, and proper disposal of any waste items.

No payment will be made for stored materials.

LUMP SUM PAYMENT ITEMS

L-1 MOBILIZATION

A mobilization pay item is included for all initial costs incurred prior to beginning work on this Contract, including permits, licenses, fees, material and/or equipment storage, etc., as well as to mobilize personnel and equipment. Payment will be made on a lump sum basis and one time only for the duration of a Contract period.

The cost for bonds and insurance shall be included in the unit prices bid for the manhole rehabilitation work and will not be paid for separately.

For each contract renewal, the Contractor shall submit documentation from the surety and insurance companies, verifying continued bonding and insurance coverage.

The Contractor will be paid only for mobilizing to the first project of the Contract or renewed Contract at the unit price bid. The Contractor will not be paid to mobilize from project to project.

UNIT PRICE ITEMS

U-1 BENCH AND INVERT REPLACEMENT

Measurement shall be based on the actual number of manhole bench and/or inverts that are replaced. Payment shall be made at the contract unit price per each, regardless of whether the entire bench and invert are replaced, for either the bench or invert. The unit price shall include removal of the existing bench and/or invert, bench and/or invert cleaning and preparation, removal of all unsuitable material, plugging or blocking active sewer mains and/or laterals (if necessary), bypass pumping (if required), rebuilding the

bench and/or invert in accordance with PWC standards, clean-up, and proper disposal of all debris and excess material, as well as all labor, materials and equipment necessary to complete bench and invert replacement prior to the installation of the manhole lining system.

Replacement of the bench and/or invert shall be at the direction of the Public Works Commission. In no case shall this line item be used without consent from the Public Works Commission. The Contractor shall provide evidence that this line item is necessary and submit it to the Public Works Commission for approval. Upon approval from the Public Works Commission, the Contractor shall proceed with utilizing this line item. All other items related to manhole cleaning and preparation, and/or repairs shall be paid for in accordance with the appropriate contract bid item.

U-2 COVER AND FRAME RESETTING

Measurement shall be based on the actual number of frames and covers re-set.

Payment shall be made at the contract unit price per each. The unit price shall include cutting and removal of surface materials as necessary (including asphalt and concrete), removal of existing cover and frame materials, cleaning of cover and frame assembly, safe handling and storage of the cover and frame, repair and preparation of manhole corbel or concrete surface as required, removal and replacement of concrete grade rings, re-installing the frame and cover in accordance with PWC requirements, reinstatement of surface, to include pavement patch, clean-up and proper disposal of all debris and excess material, as well as all labor, materials, and equipment necessary to complete the resetting of manhole cover and frame assemblies. Should PWC deem that the existing frame and cover need replacement, PWC shall provide a new cover and frame to the Contractor. The Contractor shall return the existing ring and cover to the Public Works Commission, in exchange for a new ring and cover. The Contractor should anticipate having to pick up the cover and frame at PWC's warehouse facility. No extra compensation shall be given for the contractor to travel to/from the PWC warehouse.

U-3 INSTALL LOCKING RING AND COVER

Measurement shall be based on the actual number of locking ring and covers installed. Payment shall be made at the contract unit price per each. The unit price shall include removal of the existing ring and cover, any necessary excavation to remove and/or install the ring and cover, preparation of the concrete surface as required, installing the ring and cover in accordance with PWC requirements, clean-up and proper disposal of all debris and excess materials, removal of existing concrete grade rings, and all labor, materials, and equipment necessary to complete the installation of a locking ring and cover. PWC shall furnish the locking ring and cover. The Contractor shall return the existing ring and cover to the Public Works Commission, in exchange for the new locking ring and cover. The Contractor should anticipate having to pick up the cover and frame at PWC's warehouse facility. No extra compensation shall be given for the contractor to travel to/from the PWC warehouse.

U-4 CHIMNEY SEALS

Measurement shall be based on the actual number of chimney seals installed. Payment shall be made at the contract unit price per each. The unit price shall include cleaning and preparing the manhole walls, corbelling, and manhole cover frame, furnishing and installing each chimney seal, clean-up, and all labor, materials, and equipment to install a chimney seal in accordance with the manufacturer's instructions and these Contract Documents.

In no case shall this line item be used without consent from the Owner. The Contractor shall provide evidence that this line item is necessary and submit it to the Owner for approval. Upon approval from the Owner, the Contractor may proceed with utilizing this line item.

U-5 REHABILITATE MANHOLES UTILIZING A CIP – FIBERGLASS REINFORCED EPOXY LINING (VF BASIS)

Measurement shall be based on the number of vertical feet the lining system is installed, in a four (4) foot diameter manhole. Measurement shall be from the manhole invert to the bottom of the manhole frame. Payment will be made at the contract unit price per vertical foot. The unit price shall include cleaning the manhole wall, bench, and invert, furnishing and installing all materials comprising the protective cured in place lining system from the invert to the bottom of the manhole frame, manufacturer's representative's presence or assistance if required, traffic control, necessary erosion control measures, restoration, testing, hand application of hydraulic cement or other approved material to stop leaks, plugging or blocking of active sewer lines and/or laterals, bypass pumping if required, and all other labor, materials, equipment, and incidentals necessary to obtain a watertight, sealed manhole. Lining shall include the walls, bench, and invert.

U-6 REHABILITATE MANHOLES UTILIZING A CIP – FIBERGLASS REINFORCED EPOXY LINING (SF BASIS)

Measurement shall be based on the number of square feet the lining system is installed, for manholes with a diameter greater than four (4) feet. Measurement shall be from the manhole invert to the bottom of the manhole frame, times the actual manhole inside diameter. Payment will be made at the contract unit price per square foot. The unit price shall include cleaning the manhole wall, bench, and invert, furnishing and installing all materials comprising the protective cured in place lining system from the invert to the bottom of the manhole frame, manufacturer's representative's presence or assistance if required, traffic control, necessary erosion control measures, restoration, testing, hand application of hydraulic cement or other approved material to stop leaks, plugging or blocking of active sewer lines and/or laterals, bypass pumping if required, and all other labor, materials, equipment, and incidentals necessary to obtain a watertight, sealed manhole. Lining shall include the walls, bench, and invert.

U-7 ABRASIVE BLAST CLEANING

Measurement shall be based upon the number of manholes necessary to utilize an abrasive blast cleaning to remove an existing liner material. Payment will be made at the contract unit price per each. The unit price shall include necessary cleaning to

remove existing manhole lining systems necessary to prepare the manhole to be rehabilitated under this contract. Abrasive blast cleaning shall only be applied to those areas of the manhole where normal cleaning is insufficient to remove the existing liner system. Typically, the existing lining system is a coal tar epoxy. Payment shall include all necessary labor, materials, and equipment to perform the abrasive blast cleaning prior to installation of the manhole lining system.

In no case shall this line item be used without consent from the Owner. The Contractor shall provide evidence that this line item is necessary and submit it to the Owner for approval. Upon approval from the Owner, the Contractor may proceed with utilizing this line item. All other items related to manhole cleaning and preparation shall be paid for in the unit price for "Rehabilitate Manholes Utilizing a Cured in Place Liner."

U-8 REMOVE AND REPLACE INSIDE DROP STRUCTURE

Payment for removal and replacement of existing inside drop connections in manholes will be measured by actual count, complete, in place, at the unit price bid as listed on the Bid Form. Payment shall be full compensation for all labor, equipment and materials required, including manhole connections, flexible boots, pipe and fittings, couplings, stainless steel straps and bolts, wedges and all incidental work necessary to provide a complete new inside drop connection in accordance with PWC standards.

*** END OF SECTION ***

**DIVISION 1
01300 – SUBMITTALS**

GENERAL

1.01 THE REQUIREMENT

- A. This section specifies the means of all submittals. All submittals shall be submitted to Fayetteville Public Works Commission. A general summary of the types of submittals and the number of copies required is as follows:

<u>Copies to Owner</u>	<u>Type of Submittal</u>
1	Shop drawings
1	Product samples
1	Certificates of compliance
1	Warranties

- B. All submittals shall be provided in accordance with this Section, and as outlined in Section 01000 – Supplementary Conditions. The Contractor shall refer to other Specification Sections within these Contract Documents, to ensure that all submittal requirements are adhered to. No construction shall proceed until all required submittals have been reviewed and approved by Fayetteville Public Works Commission. Any and all work performed prior to review and acceptance of the submittals by Fayetteville Public Works Commission shall be at the Contractor's sole risk. Further, failure to comply with the requirements of this Section may be considered Breach of Contract, and grounds for termination.

1.02 SUBMITTAL PROCEDURES

- A. The Contractor shall transmit each submittal with a transmittal letter/memo/form acceptable to Fayetteville Public Works Commission, clearly identifying the project and the Contractor, the enclosed material and other pertinent information specified in other parts of this section. The submittal shall identify variations from the Contract Documents and Product or system limitations which may be detrimental to successful performance of the completed Work.
- B. The Contractor shall revise and resubmit submittals as required, identifying all changes made since previous submittals. Resubmittals shall be noted as such.
- C. The Contractor shall distribute copies of reviewed submittals to concerned parties, with instructions to those parties to promptly report any inability to comply with provisions.

1.03 SHOP DRAWINGS

- A. General: The Contractor shall submit for review shop drawings for concrete reinforcement, structural details, materials fabricated especially for this Contract, and materials for which such Drawings are specified (as outlined in these Contract Documents) or as specifically requested by Fayetteville Public Works Commission.

- B. Shop drawings shall show the principal dimensions, weight, structural and operating features, type and/or brand of finish or shop coat, grease fittings, etc., depending on the subject of the Drawings.
- C. When so specified, or if considered by Fayetteville Public Works Commission to be acceptable, the manufacturer's specifications, catalog data, descriptive matter, illustrations, etc. may be submitted for review in place of shop drawings. In such case, the requirements shall be as specified for shop drawings, insofar as applicable.
- D. The Contractor shall be responsible for the prompt submittal of all shop drawings so that there shall be no delay to the Work due to the absence of such Drawings. Fayetteville Public Works Commission will review the shop drawings within 10 business days of receipt of such Drawings. Reviewed shop drawings will be returned to the Contractor by regular mail.
- E. Time delays caused by rejection of submittals are not cause for extra charges to Fayetteville Public Works Commission or time extensions.
- F. Requirements: All shop drawings shall be submitted to Fayetteville Public Works Commission through the Contractor. The Contractor is responsible for obtaining shop drawings from his subcontractors and returning reviewed Drawings to them. All shop drawings shall be prepared on standard size, 24-inch by 36-inch sheets, or smaller, as approved by Fayetteville Public Works Commission. All Drawings shall be clearly marked with the name of the project, Fayetteville Public Works Commission, Contractor, and pay item to which the drawing applies. Drawings shall be suitably numbered and stamped by the Contractor. Each shipment of Drawings shall be accompanied by a letter of transmittal giving a list of the drawing numbers and the names mentioned above.
- G. Product Data: Where manufacturer's publications in the form of catalogs, brochures, illustrations, or other data sheets are submitted in lieu of prepared shop drawings, such submission shall specifically indicate the particular item offered. Identification of such items and relative pertinent information shall be made with indelible ink. Submissions showing only general information will not be accepted.
- H. Product data shall include materials of construction, dimensions, performance characteristics and capacities, etc.
- I. Sample Warranties: When warranties are called for, a sample of the warranty shall be submitted with the shop drawings. The sample warranty shall be the same form that will be used for the actual warranty.
- J. Work Prior to Review: No material or equipment shall be purchased, fabricated especially for this Contract, or delivered to the project site until the required shop drawings have been submitted, processed and marked either "APPROVED" or "APPROVED AS NOTED". All materials and Work involved in the construction shall be as represented by said Drawings.
- K. The Contractor shall not proceed with any portion of the Work for which the design and details are dependent upon the design and details of equipment for which submittal review has not been completed.

- L. Contractor's Review: Only submittals which have been checked and corrected should be submitted to the Contractor by his subcontractors and vendors. Prior to submitting shop drawings to Fayetteville Public Works Commission, the Contractor shall check thoroughly all such Drawings to satisfy himself that the subject matter thereof conforms to the Drawings and Specifications in all respects. Drawings which are correct shall be marked with the date, checker's name and indications of the Contractor's approval, and then shall be submitted to Fayetteville Public Works Commission; other Drawings submitted to Fayetteville Public Works Commission will be returned to the Contractor unreviewed.
- M. Contractor's Responsibility: The review of shop drawings will be general and shall not relieve the Contractor of the responsibility for details of design, dimensions, etc., necessary for proper fitting and construction of the Work required by the Contract and for achieving the specified performance.
- N. Contractor's Modifications: For submissions containing departures from the Contract Documents, the Contractor shall include proper explanation in his letter of transmittal. Should the Contractor submit for review equipment that requires modifications to the structures, piping, layout, etc. detailed on the Drawings, he shall also submit for review details of the proposed modifications. If such equipment and modifications are accepted, the Contractor, at no additional cost to Fayetteville Public Works Commission, shall do all Work necessary to make such modifications.
- O. Substitutions: Whenever a particular brand or make of material, equipment, or other item is specified, or is indicated in these Contract Documents, it is for the purpose of establishing a standard of quality, design, and type desired and to supplement the detailed specifications. Any other brand or make which, in the opinion of Fayetteville Public Works Commission, is equivalent to that specified or indicated may be offered as a substitute subject to the following provisions:
 - a. Contractor shall submit for each proposed substitution sufficient details, complete descriptive literature, and performance data together with samples of the materials, where feasible, to enable Fayetteville Public Works Commission to determine if the proposed substitution is equal.
 - b. Contractor shall submit certified tests, where applicable, by an independent laboratory attesting that the proposed substitution is equal.
 - c. A list of installations (including contact information) where the proposed substitution is equal.
 - d. Where the acceptance of a substitution requires revision or redesign of any part of the Work, all such revision and redesign, and all new Drawings and details required therefore, shall be provided by the Contractor at his own cost and expense, and shall be subject to review of Fayetteville Public Works Commission.
 - e. In all cases Fayetteville Public Works Commission shall be the sole judge as to whether a proposed substitution is to be accepted. The Contractor shall abide by Fayetteville Public Works Commission 's decision when proposed substitute items are judged to be unacceptable and shall in such instances furnish the item, or substitute, as specified. No substitute items shall be used in the Work without written acceptance of Fayetteville Public Works Commission. Fayetteville Public Works Commission

reserves the right to reject any such proposed changes or substitutions at their sole discretion, and is under no obligation to justify their decision.

- f. Acceptance of any proposed substitution shall in no way release the Contractor from any of the provisions of the Contract Documents.
- P. Complete Submittals: Each submittal shall be complete in all aspects incorporating all information and data required to evaluate the products' compliance with the Contract Documents. Partial or incomplete submissions shall be returned to the Contractor without review.
 - a. Shop Drawing Distribution: The Contractor shall submit a minimum of five (5) copies of all shop drawings to Fayetteville Public Works Commission for review. Shop drawings will be reviewed, stamped and distributed with the appropriate box checked either "APPROVED", "APPROVED AS NOTED", "NOT APPROVED" or "REVISE AND RESUBMIT". Fayetteville Public Works Commission shall return three (3) copies to the Contractor and retain two (2) copies

If the Contractor requires additional copies of returned shop drawings, he shall include extra Drawings in his original submittal. Fayetteville Public Works Commission will process the Drawings and return them to the Contractor.

1.04 PRODUCT SAMPLES

- A. Contractor shall furnish for review all product samples as required by the Contract Documents or requested by Fayetteville Public Works Commission to determine compliance with the specifications.
- B. Samples shall be of sufficient size or quantity to clearly illustrate the quality, type, range of color, finish or texture and shall be properly labeled to show complete project identification, the nature of the material, trade name of manufacturer and location of the Work where the material represented by the sample will be used.
- C. Samples shall be checked by the Contractor for conformance to the Contract Documents before being submitted to Fayetteville Public Works Commission and shall bear the Contractor's stamp certifying that they have been so checked. Transportation charges on samples submitted to Fayetteville Public Works Commission shall be prepaid by the Contractor.
- D. Fayetteville Public Works Commission's review will be for compliance with the Contract Documents, and his comments will be transmitted to the Contractor within 15 business days of receipt.
- E. Acceptable samples will establish the standards by which the completed Work will be judged.

1.05 CERTIFICATES OF COMPLIANCE

- A. Copies of certificates of compliance and test reports shall be submitted for requested items to Fayetteville Public Works Commission prior to request for payment.

1.06 WARRANTIES

- A. Original warranties, called for in the Contract Documents, shall be submitted to Fayetteville Public Works Commission. When warranties are required for an item, the warranty shall be submitted prior to request for payment of that item.
- B. When warranties are requested, a sample of the warranty to be provided shall be submitted with, and considered part of, the shop drawings.
- C. The Contractor shall warrant to Fayetteville Public Works Commission that all material and labor used in the construction are covered by his warrantee for a minimum of a one (1) year period upon approval and acceptance by Fayetteville Public Works Commission. The Contractor shall replace or repair defects at no cost to Fayetteville Public Works Commission during the warrantee period.

*** END OF SECTION ***

DIVISION 1
01400 - QUALITY CONTROL

QUALITY ASSURANCE

Quality: All materials shall be new and correctly designed, and shall conform to the requirements outlined in these Contract Documents. They shall be standard first-grade quality produced by expert workmen and be intended for the use for which they are offered. Materials which, in the opinion of Fayetteville Public Works Commission, are inferior or of a lower grade than indicated, specified, or required will not be acceptable.

Source Limitations: To the greatest extent possible for each unit of Work, the Contractor shall provide products, materials, or equipment from a single manufacturer.

Compatibility of Options: If the Contractor cannot obtain all necessary products, materials, and/or equipment from a single manufacturer, the Contractor shall submit compatible products, materials, and/or equipment to Fayetteville Public Works Commission for review and approval. Once Fayetteville Public Works Commission has issued approval of the proposed products, materials, and/or equipment, the Contractor shall only utilize that manufacturer's products, materials, and/or equipment, unless otherwise approved in writing by Fayetteville Public Works Commission.

QUALITY CONTROL

Quality control is the sole responsibility of the Contractor and shall include the activities of his Subcontractors and all suppliers as required.

PRODUCT EVALUATION

Testing shall be accomplished as deemed necessary by Fayetteville Public Works Commission to ensure that the products conform to the requirements of the Contract Documents.

The work or actions of the testing laboratory shall in no way relieve the Contractor of his obligations under the Contract. The laboratory testing work will include such inspections and testing required by the Contract Documents, existing laws, codes, ordinances, etc. The testing laboratory will have no authority to change the requirements of the Contract Documents, nor perform, accept or approve any of the Contractor's Work.

The Contractor shall allow Fayetteville Public Works Commission ample time and opportunity for evaluation and testing materials to be used in the Work. The Contractor shall advise Fayetteville Public Works Commission promptly upon placing orders for materials so that arrangements may be made, if desired, for evaluation before shipment from the place of manufacture. The Contractor shall at all times furnish Fayetteville Public Works Commission and his representatives, facilities including labor, and allow proper time for evaluation and testing materials, and workmanship. The Contractor must anticipate that possible delays may occur due to the necessity of materials being inspected and accepted for use. The Contractor shall furnish, at his own expense, all samples of materials required by Fayetteville Public Works Commission for testing, and shall make his own arrangements for providing water, electric power, or fuel for the various evaluation and tests of structures and materials.

Fayetteville Public Works Commission will bear the cost of all tests, evaluation, or investigations undertaken by the order of the PWC Project Engineer for the purpose of determining conformance with the Contract Documents if such tests, evaluation, or investigations are not specifically required by the Contract Documents, and if conformance is ascertained thereby. Whenever nonconformance is determined by Fayetteville Public Works Commission as a result of such tests, evaluation, or investigations, the Contractor shall bear the full cost of any additional tests, evaluations and investigations, which are ordered by Fayetteville Public Works Commission to ascertain subsequent conformance with the Contract Documents.

EVALUATION AT PLACE OF MANUFACTURE

Unless otherwise specified, all products and materials shall be subject to evaluation by Fayetteville Public Works Commission at the place of manufacture.

The presence of Fayetteville Public Works Commission at the place of manufacture however, shall not relieve the Contractor of the responsibility for furnishing products, materials, and equipment which comply with all requirements of the Contract Documents. Compliance is a duty of the Contractor, and said duty shall not be avoided by any act or omission on the part of Fayetteville Public Works Commission.

SAMPLING AND TESTING

Unless otherwise specified, all sampling and testing shall be in accordance with the methods prescribed in the current standards of the ASTM, as applicable to the class and nature of the article or materials considered. However, Fayetteville Public Works Commission reserves the right to use any generally accepted system of sampling and testing which will ensure that the quality of the workmanship is in full accord with the Contract Documents.

Any waiver by Fayetteville Public Works Commission of any specific testing or other quality assurance measures shall not be construed as a waiver of any requirements of the Contract Documents. Fayetteville Public Works Commission may require a guarantee of substantial performance and/or a performance bond to ensure any necessary corrective or remedial Work, should a waiver be granted.

Fayetteville Public Works Commission reserves the right to make independent investigations and tests. Failure of any portion of the Work to meet any of the requirements of the Contract Documents shall be reasonable cause for Fayetteville Public Works Commission to require the removal or correction and reconstruction of any such work in accordance with the Contract Documents. In addition to any other evaluation, observation or quality assurance provisions that may be specified, Fayetteville Public Works Commission shall have the right to independently select, test, and analyze, at their expense, additional test specimens or any or all of the materials to be used. Results of such tests and analyses shall be considered along with the tests or analyses made by the Contractor to determine compliance with the applicable specifications for the materials so tested or analyzed. The Contractor shall be responsible for all costs of removal, correction, and reconstruction or repair of any such Work that fails to meet the requirements of the Contract Documents.

SITE INVESTIGATION AND CONTROL

The Contractor shall verify all dimensions in the field and shall check field conditions continuously during construction. The Contractor shall be solely responsible for any inaccuracies built into the Work due to their failure to comply with this requirement.

The Contractor shall inspect related and appurtenant Work and shall report in writing to Fayetteville Public Works Commission any conditions which will prevent proper completion of the Work. Failure to report any such conditions shall constitute acceptance of all site conditions, and any required removal, repair, or replacement caused by unsuitable conditions shall be performed by the Contractor at their sole cost and expense.

RIGHT OF REJECTION

Fayetteville Public Works Commission shall have the right, at all times, to reject any articles or materials to be furnished hereunder which, in any respect, fail to meet the requirements of the Contract Documents, regardless of whether the defects in such articles or materials are detected at the point of manufacture or after completion of the Work. If Fayetteville Public Works Commission, through an oversight or otherwise, has accepted materials or Work which is defective or which is contrary to the Contract Documents, such materials, no matter in what stage or condition of manufacture, delivery, or erection, may be subsequently rejected by Fayetteville Public Works Commission.

The Contractor shall promptly remove rejected articles or materials from the Work after notification of rejection. All costs of removal and replacement of rejected articles or materials as specified herein shall be borne by the Contractor.

WATERTIGHTNESS OF STRUCTURES

It is the intent of these Contract Documents that all Work shall be performed as required by quality construction to ensure proper sealing so that groundwater and/or rainwater will not leak into any collection line, service lateral, or manhole.

The Contractor shall provide at its own expense all labor, material, temporary bulkheads, pumps, water, measuring devices, etc., necessary to perform the required tests.

HYDRAULIC UPLIFT ON STRUCTURES

The Contractor shall be completely responsible for any pipelines or manholes that may become buoyant before the Work is completed and accepted. The Contractor shall take all necessary steps to prevent any structures from becoming buoyant. Damage to any structures due to floating or flooding shall be repaired or replaced at the Contractor's expense.

TIME OF OBSERVATION AND TESTS

Samples and test specimens required under these Contract Documents shall be furnished and prepared for testing in ample time for the completion of the necessary tests and analyses before said articles or materials are to be used. The Contractor shall furnish and prepare all required test specimens within the scope of the Contract. Except as otherwise provided in the Contract Documents, the performance and cost of the required tests will be the responsibility of Fayetteville Public Works Commission. However, the costs of any test which shows unsatisfactory results shall be borne by the Contractor. Whenever the Contractor is ready to backfill, bury, cast in

concrete, or otherwise cover any Work under the Contract, Fayetteville Public Works Commission shall be notified not less than twenty-four hours in advance to request inspection before beginning any such Work of covering. Failure of the Contractor to notify Fayetteville Public Works Commission a minimum of twenty-four hours in advance of any such inspections shall be cause for Fayetteville Public Works Commission to order a delay in the Contractor's schedule to allow time for inspections. Any remedial or corrective Work required, and all costs of such delays, including its effect upon other portions of the Work, shall be borne by the Contractor.

- END OF SECTION -

**DIVISION 1
01700 PROJECT CLOSEOUT**

FINAL CLEANUP

The Contractor shall promptly remove from the vicinity of the completed Work, all rubbish, unused materials, concrete forms, construction equipment, temporary structures and facilities, construction signs, tools, scaffolding, materials, supplies and equipment which may have been used in the performance of the work. The Contractor shall broom clean paved surfaces and rake clean other surfaces of grounds. Final acceptance of the Work by Fayetteville Public Works Commission will be withheld until the Contractor has satisfactorily complied with the foregoing requirements for final cleanup of the project site.

The Contractor shall thoroughly clean all materials, equipment and structures; all marred surfaces shall be touched up to match adjacent surfaces.

The Contractor shall remove spatter, grease, stains, fingerprints, dirt, dust, labels, tags, packing materials and other foreign items or substances from interior and exterior surfaces, equipment, signs and lettering.

The Contractor shall remove paint, clean and restore all equipment and material nameplates, labels and other identification markings.

The Contractor shall maintain cleaning until project is accepted by Fayetteville Public Works Commission.

The Contractor shall:

- A. Use only cleaning materials recommended by manufacturer of surface to be cleaned.
- B. Use each type of cleaning material on only those surfaces recommended by the cleaning material manufacturer.
- C. Use only materials which will not create hazards to health or property.

CLOSEOUT TIMETABLE

The Contractor shall establish dates for testing, acceptance periods, and on-site instructional periods (as required under this Contract). The dates shall be established a minimum of seven (7) calendar days prior to beginning any of the foregoing items, to allow Fayetteville Public Works Commission sufficient time to schedule attendance at the activities.

FINAL SUBMITTALS

Before the final acceptance of the project, the Contractor shall submit to Fayetteville Public Works Commission certain records, certifications, etc., which are specified elsewhere in these Contract Documents. Missing, incomplete or unacceptable items, as determined by Fayetteville Public Works Commission, shall constitute grounds for withholding final payment to the Contractor. A partial list of such items appears below, but it shall be the Contractor's responsibility to submit any other items which are required in these Contract Documents:

- A. Written Test results of project components.

B. Written guarantees, where required.

C. Certificates of inspection and acceptance by local governing agencies having jurisdiction.

D. Releases from all parties who are entitled to claims against the subject project, property, or improvement pursuant to the provisions of law.

PUNCH LISTS

Final cleaning shall be scheduled upon completion of the project.

Fayetteville Public Works Commission will make his final inspection whenever the Contractor has notified Fayetteville Public Works Commission that the work is ready for the inspection. Any work not found acceptable and requiring cleaning, repair and/or replacement will be noted on the punch list. Work that has been inspected and accepted by Fayetteville Public Works Commission shall be maintained by the Contractor, until final acceptance of the entire project.

Whenever the Contractor has completed the items on the punch list, the Contractor shall notify Fayetteville Public Works Commission that it is ready for final inspection. This procedure will continue until the entire project is accepted by Fayetteville Public Works Commission. The final payment will not be processed until the entire project has been accepted by Fayetteville Public Works Commission and all of the requirements in these Contract Documents have been satisfied.

TOUCH-UP AND REPAIR

The Contractor shall repair any and all damage to existing facilities and surfaces. If in the opinion of Fayetteville Public Works Commission the repair work is not satisfactory, the Contractor shall make repairs until Fayetteville Public Works Commission accepts it.

MAINTENANCE AND GUARANTEE

The Contractor shall comply with all maintenance and guarantee requirements of these Contract Documents.

Replacement of earth fill, backfill, or asphalt where it has settled below the required finish elevations, shall be considered as a part of such required repair work, and any repair or resurfacing constructed by the Contractor which becomes necessary by reason of such settlement shall likewise be considered as a part of such required repair work unless the Contractor obtained a statement in writing from the affected private owner or public agency releasing Fayetteville Public Works Commission from further responsibility in connection with such repair or resurfacing.

*** END OF SECTION ***

SECTION D – TECHNICAL SPECIFICATIONS

**DIVISION 2
SITE WORK
02222 - EXCAVATION AND BACKFILLING FOR UTILITY SYSTEMS**

GENERAL

Work described in this section consists of the excavation, backfill, compaction, and finish grading required to install the utility systems. The intent and purpose of these specifications is to require a complete and satisfactory installation in every respect and any defect in material or workmanship shall be cause for the replacement and correction of such defect as directed by Fayetteville Public Works Commission.

RELATED SECTIONS

- A. 02305 – Pipe Bursting
- B. 02660 – Water Distribution
- C. 02730 – Sanitary Sewer Systems
- D. 02732 – Sewage Force Mains
- E. Chapter 24 of the City of Fayetteville Ordinance (most recent version)

MATERIALS

Suitable soil materials are defined as those in accordance with AASHTO Soil Classification Groups A-1, A-2-4, A-2-5 and A-3 (or in accordance with ASTM D2487 soil classification groups GW, GP, GM, SM, SW, SP, SC) as determined by Fayetteville Public Works Commission. Suitable material shall be free from roots, organic matter, trash, debris, frozen material or stones larger than three (3) inches in any dimension.

Unsuitable soil materials are defined as those in accordance with AASHTO Soil Classification Groups A-2-6, A-2-7, A-4, A-5, A-6, A-7 (or in accordance with ASTM D2487 soil classification groups GC, ML, MH, CL, CH, OL, OH, and PT) as determined by Fayetteville Public Works Commission. Unsuitable material as defined above shall be replaced with select material as determined by Fayetteville Public Works Commission.

Suitable materials determined by Fayetteville Public Works Commission as too wet or too soft to provide a stable subgrade, foundation, or fill will be deemed as unsuitable regardless of soil classification. Materials deemed unsuitable shall be conditioned or replaced, as directed by Fayetteville Public Works Commission. The Contractor shall recondition and stockpile the materials at no additional cost to Fayetteville Public Works Commission.

EXCAVATION

All excavation shall be to the lines and grades indicated. The work shall consist of the excavation, placement, and compaction of suitable material as outlined in this Specification and proper disposal of all unsuitable materials. During excavation, suitable material for backfilling shall be stockpiled. The stockpiles shall be protected from contamination by unsuitable excavated material or other material. If any material becomes unsuitable, such material, if directed, shall be removed and replaced with suitable on-site or imported material from approved sources at no additional cost to Fayetteville Public Works Commission.

Where the line parallels a creek and/or ditch the excavated material shall be stockpiled opposite the creek, with the trench separating the two. Adequate drainage shall be provided for the stockpiles and surrounding areas by means of ditches, dikes, or other approved methods. Grading shall be done to prevent surface water from entering the excavation. Any water within the trench shall be removed.

Suitable excavated material shall be stockpiled or placed in the excavation's backfill. Excavation and filling shall be performed in a manner and sequence that will provide drainage at all times. Unauthorized over excavation shall be backfilled with select bedding material at no additional cost to Fayetteville Public Works Commission. The Contractor, at their expense, shall properly dispose of all excess excavated material unless directed to place it in another area of the project by Fayetteville Public Works Commission. The Contractor's obligation to remove and dispose of excess materials shall in no manner convey to him any rights of property in any material taken from any excavation.

It shall be the Contractor's responsibility to investigate the site and existing conditions. No compensation will be allowed due to excavation and/or grading being different than anticipated.

TRENCH EXCAVATION

The trench width shall be in accordance with the PWC standard details. All work shall be in accordance with the applicable OSHA regulations.

The subgrade beneath the centerline of the pipe shall provide uniform support for each section of the pipe. Stones three (3) inches or greater in any dimension, or as recommended by the pipe manufacturer, whichever is smaller, shall be removed.

Where unsuitable material is encountered at the elevation established for installation of pipe or structures, additional undercut excavation shall be done as directed by Fayetteville Public Works Commission. The additional undercut excavated area shall be backfilled with stone bedding material. Unauthorized undercut excavation shall be backfilled with stone bedding material and compacted as directed by Fayetteville Public Works Commission. The Contractor shall conduct undercut operations in such a way that Fayetteville Public Works Commission can take the necessary measurements before any backfill is placed. Any material removed and backfilled without the approval of Fayetteville Public Works Commission, and/or all necessary measurements taken, and/or to a depth, length or width exceeding the dimensions shall not be considered undercut excavation and will not be paid for such.

Where unsuitable material is encountered at the elevation established for installation of roads, parking lots, or other paved areas, additional undercut excavation shall be done as directed by the responsible agency (i.e., City of Fayetteville, Town of Hope Mills, NCDOT, etc.). The additional undercut excavated area shall be backfilled with stone bedding material. Unauthorized undercut excavation shall be backfilled with stone bedding material and compacted as directed by the responsible agency. The Contractor shall conduct undercut operations in such a way that the responsible agency can take the necessary measurements before any backfill is placed. Any material removed and backfilled without the approval of the responsible agency, and/or all necessary measurements taken, and/or to a depth, length or width exceeding the dimensions shall not be considered undercut excavation. All undercut excavation shall be in accordance with the NCDOT Standard Specification for Roads and Structures (most recent edition), or the responsible agency's specifications.

Excavation for manholes, meter vaults, or similar structures shall leave a minimum of 12-inches clear space around the structure. Removal of unsuitable material shall be as specified above. Preparation of the subgrade shall be in accordance with the applicable detail and as directed by Fayetteville Public Works Commission.

PIPE LAYING

All pipe shall be installed in accordance with PWC Specification Section 02660 – Water Distribution, Specification Section 02730 – Sanitary Sewer Systems, and/or PWC Specification Section 02732 – Sewage Force Mains.

TRENCH SAFETY

All excavations shall comply with all Federal, State, and local rules and regulations. The Contractor shall have a trenching and shoring "competent" person on the job at all times when there is an open excavation. Under no circumstance shall an employee of Fayetteville Public Works Commission be considered the "competent" person for the operation.

TRENCH STABILIZATION (SHORING)

The Contractor shall furnish, install, and maintain all necessary shoring to ensure a safe excavation. The method of shoring and excavation shall be in strict accordance with OSHA Regulations. The Contractor shall be responsible for installation, maintenance, and removal of all trench stabilization measures. The Contractor shall be responsible for any damage to adjacent structures resulting from the installation, maintenance, removal, or absence of trench stabilization measures.

DEWATERING

Excavations shall be kept dry at all times. Any required dewatering shall be the Contractor's responsibility. The Contractor shall be responsible for any damage to the adjacent property resulting from the installation, maintenance, discharge, and removal of the dewatering system. All discharge from the dewatering system shall be in accordance with the applicable erosion control rules and regulations.

BACKFILL

Backfill shall consist of suitable material free from debris, stone, etc. The backfill shall be brought up evenly on both sides of the pipe for the full length of the pipe. The backfill operation shall be conducted to prevent damage and/or movement of the pipe.

Backfill material in trenches shall be placed in layers not exceeding six (6) inches loose thickness to a point at least 12-inches above the pipe compacted to 90 percent maximum density. The remainder of the trench shall be backfilled in layers not exceeding six (6) inches in loose thickness compacted as specified in subparagraph COMPACTION. Each layer shall be thoroughly compacted by an approved mechanical tamping device.

Backfill material around structures shall be placed in a manner that the structure will not be damaged. No backfill shall be placed around manholes, thrust blocks, or similar structures until the concrete has been allowed to cure for three (3) days. The backfill material shall be compacted as specified in subparagraph COMPACTION.

No backfilling will be allowed when weather conditions prevent compliance with these Specifications.

BORROW EXCAVATION (Select Backfill)

Borrow excavation material shall be supplied by the Contractor when sufficient quantities of suitable materials are not available within the project limits. The borrow material shall be approved by Fayetteville Public Works Commission and shall not contain roots, root mats, stumps, highly plastic clay or other unsatisfactory materials. All borrow material shall be in accordance with the NCDOT Standard Specification for Roads and Structures, most recent edition.

COMPACTION

Backfill shall be compacted in accordance with the following table as a percentage of the maximum density at optimum moisture content as determined by the Standard Proctor Test, ASTM D-698.

<u>Area</u>	<u>Percent ASTM D-698 Maximum Dry Density</u>
Around and 1' above top of pipe	95
Remaining trench (within 4' of subgrade)	95
Pavement subgrade and shoulders	
Last 1' of fill (below subgrade)	100
Last 3' of fill to 12" below subgrade	98
Base material	100
Adjacent to structures (Areas not paved)	95
Under structures	98
Utility Outfalls (Cross Country)	95

Compaction testing may be performed at the option of the PWC Project Coordinator, or as required by the responsible agency (i.e., City of Fayetteville, NCDOT, etc.). Compaction testing shall be done in accordance with the responsible agency's requirements. Deficiencies shall be corrected by the Contractor without additional cost to PWC.

FINISHED EXCAVATION

All areas covered by the project shall be uniformly graded to the established elevations and approved cross sections. Ditches shall be graded to permit proper drainage. Newly graded areas shall be protected from traffic and/or from erosion, and any settlement or washing prior to acceptance shall be repaired and the required grades re-established. Ditches and drains along the subgrade shall be maintained to drain at all times. The finished subgrade shall be protected and maintained by the Contractor. The storage or stockpiling of materials on the finished subgrade shall not be permitted. No base course or pavement shall be laid until the subgrade has been checked and approved. All work shall be conducted in accordance with the environmental protection requirements of the Contract.

**DIVISION 2
SITE WORK
02272 - EROSION CONTROL - GENERAL PROVISIONS**

GENERAL

The Contractor shall be responsible for conducting his site grading and drainage operations in such manner as to prevent or lessen excessive soil erosion of the construction site work areas. He shall at all times provide satisfactory means to prevent or minimize the movement and washing of large quantities of soil. The Contractor is expected to review his site grading and drainage operations periodically to determine the areas most susceptible to erosion by excessive rainfall and periodically maintain all installed measures for the project duration. The Contractor shall correct any deficiencies or problem areas as directed by the Owner or the North Carolina Department of Environment and Natural Resources (NCDENR) inspector within 48 hours.

EXECUTION

The Contractor's attention is directed to the fact that unless exposed earth areas are properly cared for during construction, they may result in substantial sedimentation damage downstream from the construction area. He shall at all times provide satisfactory means to prevent or minimize the movement and washing of quantities of soil onto pavements or into adjacent ditches, swales, inlets, and drainage pipes, to avoid the possibility of these structures becoming clogged with soil. Should this happen as a result of erosion at the site of this construction, the Contractor will be required to immediately provide means for removal of the soil and/or debris from the structures to restore the proper functioning of these structures. The Contractor shall assume all responsibilities to the affected property owners for correction of all damages. The Contractor is expected to review his site grading and drainage operations periodically with the Owner with the view in mind of determining the areas most susceptible to erosion by excessive rainfall and shall take necessary temporary measures in sufficient time to minimize the washing away of the site soils that would likely occur before the areas are finished graded, topsoiled and planted. The temporary measures to be provided by the Contractor at the critical areas may consist of, but not limited to, any one or a combination of the following, or by other approved means selected by the Contractor:

Silt Fence
Gravel Construction Entrance/Exit
Inlet Protection

If any earthwork is to be suspended for any reason whatsoever for longer than 15 days, the disturbed areas shall be seeded with temporary vegetative cover or otherwise protected against excessive erosion during the suspended period. Suspension of work in any area of operation does not relieve the Contractor of the responsibility for the erosion control and temporary measures will not be considered cause for a change in the price bid.

MAINTENANCE

The Contractor shall inspect and maintain each erosion control measure until the project is stabilized and accepted. After each significant rainfall, the Contractor shall remove and dispose of silt accumulation from each individual measure. The following maintenance may be required for each specific erosion and sediment control measure:

Silt Fence: Fabric shall be removed and replaced whenever deteriorated to such an extent the effectiveness is reduced. The toe of the fabric shall be buried a minimum of 6 inches.

Gravel Construction

Entrance/Exit: Periodic top dressing with two inches (2") of graded stone. Remove all objectionable Materials spilled, washed or tracked onto public roadways.

Sediment

Trap: Remove sediment and restore trap to original dimensions when accumulated silt volume equals $\frac{1}{2}$ the design depth. Replace the contaminated gravel facing.

Gravel Inlet

Protection: Remove sediment as necessary to provide adequate volume. Replace contaminated gravel facing if required.

Rip-Rap: Make repairs to dislodged stone and/or supplement as required if erosion occurs during heavy rainfalls.

REMOVAL

After the area has been stabilized and the project accepted, the Contractor shall remove all temporary erosion and sediment control measures. Silt fences shall be removed, sediment traps/pits and/or basins filled with suitable soil, compacted and seeded. The materials removed shall remain the property of the Contractor and shall be disposed of off-site, or may be reused in other locations if approved by the Owner.

**DIVISION 2
SITE WORK
02273 - TEMPORARY SILT FENCE**

GENERAL

The work covered by this section consists of furnishing, installing, maintaining and removing a water permeable filter type silt fence for the purpose of removing suspended particles from the water passing through it.

The quantity of temporary silt fence to be installed will be affected by the actual conditions which occur during the construction of the project. The quantity of temporary silt fence may be increased, decreased, or eliminated entirely at the direction of the Owner. Such variations in quantity will not be considered as alterations in the details of construction or a change in the character of the work.

MATERIALS

Either wood posts or steel posts may be used. Wood posts shall be a minimum of 6 feet long, at least 3 inches in diameter, and straight enough to provide a fence without noticeable misalignment. Steel posts shall be 5 feet long, 1 3/4 inches wide and have projections for fastening the wire to the fence.

Wire fence fabric shall be at least 32 inches high, and shall have at least 6 horizontal wires. Vertical wires shall be spaced 12 inches apart. The top and bottom wires shall be at least 10 gage. All other wires shall be at least 12½ gage.

Burlap shall be at least 36 inches wide and shall weigh at least 6.7 ounces per square yard. Other materials may be used in lieu of burlap, provided those materials have been approved by the North Carolina Department of Environment and Natural Resources (NCDENR).

Wire staples shall be No. 9 staple and shall be at least 1½ inches long.

INSTALLATION

The Contractor shall install temporary silt fence as shown on the plans and details. The silt fence shall be constructed at the locations shown on the plans and at other locations directed by the Owner. Posts shall be installed so that no more than 3 feet of the post shall protrude above the ground and at least 18 inches are driven into the ground. Filter fabric shall be attached to the wire fence fabric by wire or other acceptable means. The fabric shall be continual in length. The fabric shall extend into a 6"x 6" trench along the uphill side of the fence. The trench shall be backfilled and compacted. Place 6 inches of No. 57 stone along the toe of the fence to secure the fabric in place. The single stripe located approximately 6 inches from the silt fence outer edge should not be visible if the fabric and fencing are installed properly.

**DIVISION 2
SITE WORK
02274 - GRAVEL CONSTRUCTION ENTRANCE/EXIT**

GENERAL

The work covered by this section consists of furnishing, installing, maintaining and removing temporary gravel construction entrance/exits. The entrance/exit shall be located at points where vehicles enter and exit the project and as indicated on the plans to limit sediment "tracked" off the site.

Where there are differences or conflict between this specification and those requirements outlined in an approved Erosion Control Plan, the specifications in the erosion control plan shall take precedence

MATERIALS

The stone shall be two inch (2") to three inch (3") washed stone.

INSTALLATION

The Contractor shall install the gravel construction entrance as shown on the plans and details. The construction entrance shall be constructed at the locations shown on the plans and at other locations directed by the Engineer.

The area to receive the stone shall be cleared of all vegetation, roots and other objectionable materials. The subgrade shall be graded and properly compacted. Areas yielding shall be covered with engineering fabric or undercut as directed by the Engineer. The stone shall be placed, graded and compacted to a minimum depth of eight inches (8") and as shown on the plans. The minimum construction entrance dimensions shall be 50 feet in length and 12 feet in width. The construction entrance/exit shall be maintained and the stone supplemented throughout the life of the project and shall be removed upon stabilization and disposed of off-site at the Contractor's expense.

**DIVISION 2
SITE WORK
02275 - BLOCK AND GRAVEL INLET PROTECTION**

GENERAL

The Contractor shall install block and gravel inlet protection when storm drain inlets are to be made operational before permanent stabilization of the disturbed drainage area. The inlet protection applies to areas of heavy runoff and provides for overflow capacity to prevent excessive ponding; however, shallow temporary flooding should be anticipated.

INSTALLATION

The Contractor shall install the block and gravel inlet protection as shown on the detail drawing and at the locations indicated. As an option, the concrete blocks may be omitted and the entire structure made of gravel and stone. A structure made entirely of stone is commonly called a "gravel doughnut". In this case, keep the stone slope toward the inlet at 3:1 or flatter. Stone shall be washed stone with minimum 3 inch size on the basin side for stability and 1 inch or smaller (No. 57) on the flow side.

**DIVISION 2
SITE WORK
02500 – TRAFFIC CONTROL**

GENERAL

The purpose of these specifications is to outline the Contractor's requirements for furnishing, erecting, maintaining, relocating, and removing traffic control devices for the maintenance of traffic during the Contractor's construction operations. The Contractor shall furnish all labor, materials, accessories, equipment and tools for performing all required traffic control operations.

REFERENCES

All work shall be in accordance with:

- A. The North Carolina Department of Transportation Standards and Specifications for Roads and Structures (most recent edition)
- B. The North Carolina Department of Transportation Roadway Standard Drawings (most recent edition)
- C. The Manual on Uniform Traffic Control Devices (MUTCD) – most recent edition
- D. The North Carolina Supplement to the MUTCD
- E. Section 01000 – Supplementary Conditions, of these Contract Documents

REQUIREMENTS

TRAFFIC CONTROL PLAN

The Contractor shall submit a traffic control and phasing plan for the overall project to be reviewed and approved by the PWC Project Engineer, prior to starting construction. The Contractor shall obtain an approved copy of the traffic control plan for the overall project area prior to any excavation within roadways. The plan must indicate how traffic will be managed, signage to be used, and potential traffic patterns resulting from plan implementation. The plan shall be submitted to the PWC Project Engineer in accordance with Section 01000 "Supplementary Conditions" and Section 01300 "Submittals" of these Contract Documents. Failure of the Contractor to submit the required traffic control plan sufficiently in advance shall not entitle the Contractor to any extension of Contract Time.

TRAFFIC CONTROL DEVICES

The Contractor working in public rights-of-way on streets open to vehicular traffic, shall be required to provide, erect, and maintain all necessary traffic control devices throughout the project area to include any connecting streets affected by construction activities. The Contractor shall provide a sufficient number of personnel, and take all precautions for the protection of the work and safety of the public. All traffic control devices in place shall be in accordance with the approved traffic control plan. All traffic control devices and device installation shall be placed and maintained in strict accordance with the resources listed above.

The Contractor shall be liable for any damages resulting from using unapproved and/or inadequate work zone traffic control. Fayetteville Public Works Commission reserves the

right to stop any work for non-compliance. The Contractor shall have no claim for delay due to stoppage of work as a result of non-compliance.

TRAFFIC CONTROL PLAN AND ROAD CLOSURE NOTIFICATION

1. TRAFFIC CONTROL PLAN – The Contractor shall notify the PWC Project Engineer, in writing, by 5:00 p.m. Wednesday, indicating which roadways will be affected by the work the following week. The Contractor shall notify NCDOT of work to be done per the terms of the approved encroachment agreement. The PWC Project Engineer shall receive copies of all correspondence via fax or email (PWC fax 910-829-0203; email addresses will be provided at the pre-construction meeting).

Traffic cannot be altered without notification and approval from the appropriate agency as outlined in the above paragraph. Failure to do so will result in the Contractor not being able to work within the street the next week.

No work on the individual streets shall start until all the traffic control devices required for the particular work activity have been installed in accordance with the approved traffic control plan.

2. ROAD CLOSURE NOTIFICATION - When deemed to be in the best interest of the public, Fayetteville Public Works Commission and the Contractor, a street may be closed for a duration mutually agreed upon. The Contractor shall submit a request in writing to the PWC Project Engineer for approval to have a street closed. The PWC Project Engineer will forward the request to the appropriate agency (i.e., City, Hope Mills, NCDOT) for approval of the closure. The PWC Project Engineer will include their recommendation regarding approval or disapproval of the request. The PWC Project Engineer will respond in writing with any recommendation for approval or disapproval of the request.

The request shall be submitted a minimum of five (5) business days prior to the desired closure date. The request shall include the street name and the limits of the closure based on the points of intersection. The request shall also state the proposed duration the street is to be closed and shall include a traffic control plan showing the detour route, traffic control devices, etc. The traffic control plan submitted shall be in accordance with the requirements listed in this Specification.

Once the street closure has been approved, in writing, by the PWC Project Engineer, the Contractor accepts full responsibility for the closure, to include the installation, maintenance, and removal of all traffic control devices and all implied liability.

TRAFFIC CONTROL LOOPS

The Town of Hope Mills, City of Fayetteville, and NCDOT maintain traffic detection loops at various intersections throughout the project limits. Due to the location of the proposed utility improvements, it may be necessary for these detection loops to be damaged. The Contractor shall coordinate with the appropriate agency a minimum of three (3) days prior to excavating, in order for the agency to locate these loops, or make any necessary revisions to the traffic signal facilities.

The Town of Hope Mills will hire a third-party contractor to repair the damaged traffic detection loops. The invoice for this work shall be submitted to the Contractor for payment. The cost for this shall be incidental to the Contract.

STEEL PLATING ROADWAYS

Steel plating shall not be used without the prior written approval of the Project Engineer. The Contractor shall submit their proposed plan to utilize steel plates a minimum of five (5) working days prior to the proposed activity. Plating shall only be considered if the trench depths are 14 feet or greater. Should plating be approved the Contractor shall adhere to the following:

1. The trench shall be adequately shored to support bridging and traffic loads.
2. The trench box shall be sealed so there are no open voids.
3. Steel plates shall rest on trench box.
4. Steel plates shall extend beyond the outer edges of the trench box on all four sides.
5. There must be a minimum of two (2) feet of compacted backfill above steel plates.
6. Compacted backfill shall match existing street grade.
7. Provide documentation that the plates are capable of supporting potential loads.

Steel plating shall not exceed two (2) consecutive calendar days in any given week. However, provided that work is progressing in that particular section of sewer the Contractor may be allowed to utilize plating for a longer duration as approved in writing by the Project Engineer.

STEEL PLATING ROADWAYS (NCDOT STREETS)

Steel plating shall not be used without the prior written approval of Fayetteville Public Works Commission Project Engineer. The Contractor shall submit their proposed plan to utilize steel plates a minimum of five (5) business days prior to the proposed activity. Should plating be approved, the Contractor shall adhere to the following:

1. The plates shall be secured against any movement from traffic. Options include “countersinking” the plates to be flush with the existing pavement, or bolting the plates to the pavement.
2. The plates shall overlap the excavation a minimum of two (2) feet on all sides.
3. The plates shall be sufficient to withstand the expected traffic loads.
4. Provide documentation that the plates are capable of supporting potential loads.

Steel plating shall not exceed two (2) consecutive calendar days in any given week. However, provided that work is progressing in that particular section of the project, the Contractor may be allowed to utilize plating for a longer duration as approved in writing by Fayetteville Public Works Commission Project Engineer.

MATERIALS

- A. The Contractor shall utilize interim pavement marking paint as specified in the North Carolina Department of Transportation Standards and Specifications for Roads and Structures (most recent edition)

- B. Traffic cones may be utilized when approved by Fayetteville Public Works Commission Project Engineer. If approved, traffic cones shall either be double stacked or weighted to prevent movement by traffic.
- C. All traffic control devices furnished by the Contractor shall remain the property of the Contractor, unless otherwise specified in these Contract Documents.

INSTALLATION

The furnishing, erecting, maintaining, relocating, and removal of traffic control devices shall be in accordance with the MUTCD (most recent edition), the requirements outlined in the approved traffic control plan, and these Contract Documents.

All traffic control devices shall be in place prior to the Contractor beginning work, removed during intervals when work is not on-going, and removed at the end of each business day (unless otherwise approved, as outlined in this specification).

The Contractor shall not obstruct or impede any traffic on adjacent streets, during the installation or removal of the traffic control devices, or during construction.

The Contractor shall not close a lane to through traffic after normal working hours and during periods of construction inactivity, unless otherwise approved in writing by Fayetteville Public Works Commission Project Engineer.

Fayetteville Public Works Commission Project Engineer may restrict the Contractor from placing lane closures during certain hours, holidays, or as deemed necessary for the convenience of the public. All lane closure types, hours of installation, and durations shall be as approved in writing by Fayetteville Public Works Commission Project Engineer.

The use of police and/or trained flaggers to control traffic through the work site shall be provided by the Contractor as required. The Contractor shall be responsible for obtaining trained personnel to direct traffic and contacting local authorities for use of police for traffic control where applicable.

INTERIM PAVEMENT MARKINGS

The Contractor shall be required to place interim pavement markings (centerlines, lane lines, edge lines, railroad, and school symbols) daily on any street with existing pavement markings that have been obliterated.

THERMOPLASTIC PAVEMENT MARKINGS

The Contractor shall be required to place thermoplastic pavement marking centerlines, lane lines, and edge lines within three (3) calendar days after the completion of the resurfacing operation.

The Contractor shall be required to place all thermoplastic pavement marking symbols (arrows, crosswalks, stop lines, school symbols, railroad symbols, raised pavement markers, etc.) within seven (7) calendar days of the completion of the project.

NCDOT STREETS

All traffic control measures for work within NCDOT road rights-of-way shall be in accordance with the approved NCDOT encroachment agreement, and as specified herein. Where there is a

conflict between the requirements of this specification and the approved encroachment, the requirements of the approved encroachment shall govern.

END OF SECTION

**DIVISION 2
SITE WORK
02730 - SANITARY SEWER SYSTEMS**

GENERAL

Sanitary sewer lines and all appurtenant items shall be constructed of materials specified or indicated on the drawings. The intent and purpose of these specifications is to require a complete and satisfactory installation in every respect and any defect in material or workmanship shall be cause for the replacement and correction of such defect as directed by the Public Works Commission.

RELATED SECTIONS

- A. 02211 – Grading, Utilities
- B. 02222 – Excavation and Backfilling for Utility Systems
- C. 02732 – Sewage Force Mains

MATERIALS

SEWER MAINS

Prior to shipment each joint of pipe shall be stamped by an independent testing laboratory, certifying compliance with the specifications stated therein. Pipe sizes indicated shall be understood to be nominal inside diameter of the pipe. All sewer pipe materials shall be either PVC (as specified herein) or ductile iron (as specified herein), unless otherwise approved in writing by the Public Works Commission. Written approval shall be obtained prior to installation.

DUCTILE IRON PIPE

All ductile iron pipe and fittings shall be in strict accordance with ANSI A21.51 and AWWA C151, Class 50 or Class 51, as applicable, in every respect. The working pressure shall be a minimum of 200 psi. Pipe shall be furnished in 18 or 20-foot lengths. All pipe joints used in open trench construction shall be furnished with "push-on" joints, unless otherwise indicated on the drawings or specified. All joints and fittings shall be in accordance with ANSI A21.11 and AWWA C111. All ductile iron interior surfaces shall be lined with two (2) coats of ceramic epoxy to produce a total minimum dry film thickness of 40 mils (Protecto401 or approved equal). The exterior pipe surfaces shall be protected with asphaltic coating as specified in AWWA C151 and C110. Specifications for the ceramic epoxy can be found in Specification Section 09802.

For aerial crossings which are 4 inches through 12 inches in diameter, manufactured restrained joint ductile iron pipe Class 53, or Class 53 flanged ductile iron pipe shall be utilized in accordance with the standard Public Works Commission detail for aerial crossings. Mega-lugs, field-lok, and gripper rings are not an allowable means of restraint for aerial crossings. For aerial crossings larger than 12 inches, or as noted specifically on the plans, flange joint ductile iron pipe, Class 53, shall be utilized in accordance with the standard Public Works Commission details. The location of flanges shall be specifically designed for each application. The flange pipe shall be in accordance with ANSI/AWWA C-115/A21.15. Threads for threaded flange pipe shall be in accordance with ANSI B2.1, shop fabricated as outlined by AWWA 115 with serrated faces furnished on the pipe, completely factory installed. Welding of flanges to the body of the pipe will not be acceptable. Ductile iron fittings and flanges shall be in accordance with

ANSI/AWWA C-110/A21.10 with a minimum working pressure of 250 psi. Gaskets shall be full faced SBR rubber per ANSI/AWWA C-111/A21.11 with a minimum 1/8" thickness. Linings and coatings shall be as outlined for ductile iron pipe.

If the Public Works Commission determines that an expansion coupling is required, it shall be installed as indicated on the drawings. The expansion coupling shall not be buried.

For subsurface water crossings (i.e., streams, wetlands), restrained joint ductile iron pipe shall be utilized. No mechanical restraint systems (e.g., mega-lugs, field-lok gaskets, etc.) shall be utilized. The pipe shall be installed in a casing, in accordance with the approved Public Works Commission detail, unless otherwise specifically approved by the Public Works Commission.

PVC PIPE

PVC sewer pipe and fittings 4 inches thru 15 inches shall be in accordance with ASTM D-3034 with a standard dimension ratio (SDR) of 26 for sewer mains and laterals. Larger diameter pipe (18 inches through 27 inches) shall be in accordance with ASTM F-679, with a SDR of 26. Both pipe and fittings shall be made of PVC plastic having a cell classification of 12454 as specified in ASTM D-1784.

Pipe joining shall be push on elastomeric gasket joints only and the joints shall be manufactured and assembled in accordance with ASTM D-3212. Elastomeric seals shall meet the requirements of ASTM F-477. The pipe shall be furnished with integral bells and with gaskets that are permanently installed at the factory and in accordance with ASTM D-3212 and contain a steel reinforcing ring. PVC sewer pipe shall be made by continuous extrusion of prime green unplasticized PVC and contain identification markings as required by the applicable ASTM standard.

SEWER FITTINGS

Ductile Iron Push-on Fittings:

Ductile iron sewer fittings on PVC mains shall be deep bell, gasketed joint, and air test rated. Gasket grooves shall be machined in the factory. Material shall be ductile iron, in accordance with ASTM A536, Grade 65-45-12 and ASTM F1336. Wall thickness shall meet the requirements of AWWA C153. Gaskets shall have a minimum cross sectional area of 0.20 square inches, and conform to ASTM F477. All ductile iron fittings shall have an interior coating of Protecto 401, or approved equal. All ductile iron fittings on PVC pipe shall provide a flow line that provides a smooth transition between the materials. Ductile iron fittings shall be as manufactured by the Harrington Corporation (Harco), or approved equal.

Mechanical Joint Fittings:

Joints shall be installed in accordance with AWWA C-600 and shall conform to AWWA Standard C-111. Mechanical joints shall be of the stuffing box type and shall conform to ANSI A21.11 for four inch (4") pipe and larger. Fittings and specials shall be ductile iron and shall be manufactured in accordance with AWWA Standard C-110 (ANSI A21.11). Compact fittings shall be ductile iron in accordance with ANSI A 21.53 (AWWA C-153) for 4" thru 24" sizes only. Note: mechanical joint wyes are not included in the AWWA C-153 specification. Pressure rating shall be not less than 200 psi unless otherwise specified. All ductile iron fittings shall have an interior coating of Protecto 401, or approved equal. Mechanical joint fittings shall be utilized on

ductile iron mains and ductile iron laterals. Mechanical joint fittings shall not be utilized on PVC mains, unless otherwise approved by the Public Works Commission.

PVC Fittings:

PVC fittings shall be manufactured in accordance with ASTM D-3034, F-1336, and F-679. Molded fittings shall be utilized in sizes from 4" to 8" (or larger, if available). Fabricated fittings shall only be utilized with prior approval from the Public Works Commission. Fabricated fittings are defined as those fittings that are made from pipe or a combination of pipe and molded components. All PVC fittings shall contain identification markings as required by the applicable ASTM standard. All PVC fittings shall be gasketed joint, except as indicated for interior drop structures. Plastic fittings shall be as manufactured by GPK Products, Inc., Plasti-Trends, the Harrington Corporation (Harco), or approved equal.

Ductile Iron Pipe Size x SDR26 Transition Adapter:

All ductile iron x PVC transition adapters shall be one (1) piece, bell x bell (gasket x gasket). Transition adapters shall range in size from four (4) inches through 12 inches. Transition adapters for pipe larger than 12-inches shall be as specified by the Public Works Commission. All transition adapters shall have a flow way tapered to allow a smooth transition between the ductile iron and PVC. Transition adapters shall be either PVC or ductile iron, in accordance with the following:

PVC – All PVC transition fittings shall be made from DR 18 C900 pipe stock. The C900 pipe stock shall meet the requirements of AWWA C900/C905, and have a minimum cell classification of 12454 as defined in ASTM D1784. The wall thickness shall meet or exceed DR 18. PVC transition fittings shall have SBR gaskets in accordance with ASTM F477. All six (6) inch and eight (8) inch adapters shall be molded. Molded fitting joints shall be 235 psi rated, in accordance with ASTM D3139, and shall have SBR rubber gaskets. Four (4) inch, ten (10) inch and 12 inch transition adapters shall have SBR Rieber style gaskets meeting ASTM F477. Joints shall be 235 psi rated, in accordance with ASTM D3139 for the C900 (ductile iron) bell, and in accordance with ASTM D3212 for the sewer (SRD26) bell. Molded C900 bell depths shall comply with AWWA C907. Fabricated (4-inch, 10-inch and 12-inch) bell depths and molded sewer (SDR26) bell depths shall be in accordance with ASTM F1336. PVC transition adapters shall be manufactured by the Harrington Corporation (Harco), GPK Products, or approved equal.

Ductile iron – Ductile iron transition fittings shall be deep bell, push-on joint, and air test rated. The ductile iron material shall comply with ASTM A536, Grade 65-45-12 or 80-55-06. The bell depth shall be in accordance with ASTM F1336. Gaskets shall be of SBR rubber, in accordance with ASTM F477. Transition gaskets are not allowed. All ductile iron transition fittings shall have an interior coating of Protecto401 or approved equal. Ductile iron transition fittings shall be manufactured by the Harrington Corporation (Harco) or approved equal.

Saddles:

Sewer service saddles may be utilized for sewer lateral installations. All sewer service saddles shall be ductile iron with stainless steel straps, bolts, nuts, and washers. The nuts shall be coated to prevent galling. The saddle body shall be ductile iron, in accordance with ASTM A536, Grade 65-45-12. The gasket material shall be SBR, in accordance with ASTM D2000. Saddles for PVC or DI laterals shall have an alignment flange. Sewer service saddles shall be as manufactured by Geneco, or approved equal. All stainless steel straps shall be pre-formed at the factory, to the specified outside diameters of the pipe.

SEWER LATERALS

Ductile iron laterals – For ductile iron mains, utilize mechanical joint fittings or an approved saddle with an alignment flange (Geneco or approved equal). For PVC mains, utilize an approved saddle with an alignment flange (Geneco or approved equal) or ductile iron fittings as specified above.

PVC laterals – utilize a saddle with an alignment flange (Geneco or approved equal) on PVC or ductile iron mains; utilize a mechanical joint tee with SDR 35 transition gaskets on ductile iron mains; or utilize PVC fittings as specified above on PVC mains.

The following table summarizes the materials to be utilized for sewer main to lateral connections:

	PVC Main	DI Main
DI Lateral	DI fitting or approved saddle	MJ fitting or approved saddle
PVC Lateral	PVC fitting or approved saddle	MJ fitting with transition gasket or approved saddle

Sewer laterals shall be in accordance with these Specifications and PWC standard details S.10, S.11, and S.12.

PRECAST CONCRETE MANHOLES

Pre-cast circular reinforced concrete manhole units shall be in accordance with ASTM C-478. The tongue and groove ends of the manhole sections shall be manufactured for jointing with rubber gaskets (i.e., con-seal). An eccentric cone shall be utilized on all manholes, unless otherwise approved by the Public Works Commission.

Manhole steps shall be placed in all manholes and shall be steel reinforced (½" grade 60) copolymer polypropylene plastic steps in accordance with ASTM C-478 for material and design. The steps shall be spaced 16" on center with serrated treads and wide enough to stand on with both feet.

Manhole frames and covers shall be made of gray cast-iron, and the iron shall possess a tensile strength of not less than 18,000 psi. Cast iron shall conform to ASTM Specification A 48-83 Class 35. The frame and cover shall be manufactured by the same manufacturer. All castings shall be in accordance with Public Works Commission standard details. Any defective castings shall be removed and replaced.

Any special linings and coatings that are specified for a manhole and installed at the production facility, in the field, or during repairs, shall be applied in accordance with the applicable special coatings specification and the manufacturer's specifications for that material.

Camlock ring and covers shall be in accordance with Public Works Commission standard details. Camlock bolt head shall be compatible with PWC standard tool for turning camlock mechanism. Camlock ring and covers shall be installed as indicated on the drawings, in accordance with PWC standard details.

SELECT BEDDING MATERIAL

Select bedding material shall be crushed stone (No. 57 or No. 5), in accordance with Public Works Commission standard details. Bedding material shall be provided for all pipe materials.

INSTALLATION

Pipe installation shall be in strict accordance with Specification Section 02222 – Excavation and Backfilling for Utility Systems and as outlined herein.

PIPE LAYING

Pipe installation shall be in accordance with the manufacturer's instructions. Proper equipment shall be utilized to perform the work in a manner satisfactory to PWC. All pipes and fittings shall be carefully lowered into the trench in such a manner to prevent damage to the protective coatings and linings. Under no circumstances shall pipe materials be dropped or dumped into the trench. Pipe shall be carried into position and not dragged.

All dust, dirt, oil, tar (other than standard coating), or other foreign matter shall be cleaned from the jointing surfaces, and the gasket, bell, and spigot shall be lubricated with lubricant recommended by the manufacturer.

The pipe shall be laid upgrade, beginning at the lower end with the tongue or spigot ends pointing in the direction of the flow to the correct line and grade, unless otherwise approved by PWC. The pipe section to be installed shall be aligned by batter board or laser beam with the last installed pipe section. Mechanical equipment should not be used to assemble the pipe. Pipe shall be assembled in accordance with the pipe manufacturer's instructions. Any damage resulting from the use of mechanical equipment shall be replaced as directed by PWC.

Adjustments in grade by exerting force on the barrel of the pipe with excavating equipment shall not be allowed. The Contractor shall verify line and grade after assembling each joint.

At any time when pipe laying is not in progress, the open ends of the pipe shall be closed by a water tight plug or other means approved by the PWC Project Coordinator. If water is in the trench, the plug shall remain in place until the trench is pumped completely dry. No pipe shall be laid in water or where in the PWC Project Engineer's and/or PWC Project Coordinator's opinion trench conditions are unsuitable. Every precaution shall be taken to prevent material from entering the pipe while it is being installed.

ALIGNMENT AND GRADE

All pipe shall be installed to the required lines and grades. Structures shall be installed at the required locations. The lines and grades of the pipe will generally be indicated by stakes parallel to the line of the pipe. The Contractor shall be responsible for installing the pipe to proper line and grade.

Pipe shall be visually inspected by shining a light between structures and /or by closed circuit television inspection. Any defects discovered, including poor alignment, shall be corrected as directed by the Public Works Commission.

The bottom of the trench shall be excavated to a minimum of four inches (4") below the outside bottom of the pipe being installed to allow adequate placement and compaction of bedding material prior to installation.

Select bedding material shall be placed a minimum of four inches (4") and a maximum of six inches (6") under the pipe for full width of the trench and halfway up the pipe on the sides. Bedding material shall be placed in layers not exceeding six inches (6") loose thickness for compacting by vibratory mechanical tamps under the haunches and concurrently on each side of the pipe for the full width of the trench. The final result shall be "Class B" bedding for rigid pipe. If the existing material under the pipe bedding material is unsuitable, the unsuitable material shall be removed and replaced with select bedding material (No. 57 or No. 5 stone), as authorized and approved by the Public Works Commission Project Coordinator.

The same material pipe shall be utilized from manhole to manhole, unless otherwise approved by PWC. If the section of pipe between manholes is 250 feet or less, no transitions will be allowed (either all PVC or all ductile iron). Should the length between manholes exceed 250 feet, only one transition will be allowed. Use of a C900 x SDR 26 adaptor shall be used to accomplish the transition. A transition is defined as the use of one C900 x SDR26 adaptor. No more than one (1) adaptor shall be utilized in any given manhole to manhole segment.

All manholes shall be constructed to Public Works Commission's standards. Installation shall be in accordance with ASTM C-891 and PWC standards.

Manholes shall be constructed of precast reinforced concrete circular sections installed on a base riser section with integral floor and shall be cored to accommodate the various pipe connections, as indicated on the drawings. Pipe connections to a manhole shall be by gasketed flexible watertight connections (boot for small diameter and A Loc for larger diameter pipe) or as approved by the Public Works Commission. The manhole size shall be in accordance with the following table, unless otherwise specified:

<u>Pipe Size</u>	<u>Manhole Diameter</u> **
24" and less	48" *
27" - 36"	60"
42"	72"

* Where interior drop structures are required, use 60" diameter as required in the Public Works Commission standard details.

** Where multiple connections or acute angles are required, larger diameter manhole may be required as indicated on the plans.

The invert channel shall be constructed of brick and mortar, in accordance with Public Works Commission standard details. **Precast inverts are not allowed.** The invert channel shall be smooth and semicircular in shape conforming to the inside of the connecting sewer section. Changes in direction of flow shall be made with a smooth curve as large as a radius as the size of the manhole will permit without a decrease in flow velocity. Changes in size and grade of the channel shall be made gradually and evenly. The invert channel walls shall be constructed to three quarters (3/4) of the height of the crown of the outlet sewer and in such a manner not to obstruct maintenance, inspection or flow in the sewers. The inverts shall have a minimum slope of one (1) percent across the bottom of the manhole. A shelf shall be provided on each side of any manhole invert channel. Inverts in manholes with standing water will not be acceptable. The shelf shall be sloped not less than 1:12 (min) and no more than 2:12 (max). The bottom of the boot for the new sewer main or lateral shall be set one inch above existing shelf unless otherwise indicated.

When used in a paved street, the ring and cover shall be set in suitable mortar surrounded by a concrete collar in accordance with Public Works Commission standard details. When used in places other than in a paved street, the ring and cover shall be set to the grade shown on the plans or directed by the Public Works Commission. In unpaved areas cam-lock ring and cover shall be used. Camlock ring and cover shall be installed in accordance with Public Works Commission standard details.

The interior manhole riser joints, lift holes and grade adjustment rings shall be sealed with non-shrinking mortar to provide a watertight manhole. Lift holes sealed by the manufacturer with plastic caps do not require mortar seal. The hardened mortar shall be smooth to rub with no sharp edges. Use of grade rings with cam-lock ring and cover are not allowed, unless approved by the PWC Project Coordinator. **Use of grade rings is not allowed for above grade adjustments.**

All exterior manhole riser joints, including the joint at the cone, shall be sealed with an external rubber sleeve. The sleeve shall be made of stretchable, self-shrinking rubber, with a minimum thickness of 30 mils. The back side of each wrap shall be coated with a cross-linked reinforced butyl adhesive. The butyl adhesive shall be a non-hardening sealant, with a minimum thickness of 30 mils. The seal shall be designed to stretch around the manhole joint and then overlap to create a fused bond between the rubber and butyl adhesive. The application shall form a continuous rubber seal for the life of the application. The sealing system shall be as manufactured by Concrete Sealants, Inc. (Con-Seal), Sealing Systems, Inc., or approved equal. The wrap shall be a minimum of six (6) inches in width, and shall be centered on the joint. All manhole joints (including the cone section to the last riser) shall be wrapped and sealed. Care shall be taken to prevent damage to the wrap during backfill operations. The manhole surface shall be prepared in accordance with manufacturer's specifications, prior to installing the joint wrap.

Materials shall not enter the sewer line during construction of the manhole. The manhole shall be kept clean of any and all debris or materials. Any debris or material that entered the manhole shall be immediately removed. This condition shall be maintained until final acceptance of the work.

CONNECTION TO EXISTING MANHOLES OR LIFT STATIONS

All connections to existing manholes and/or lift stations shall be approved by the Public Works Commission. Where new mains are to be connected to existing active sanitary sewers, the active sewers shall remain in service. Unless otherwise indicated, where new lines are connected into existing manholes, all or such portion of the manhole invert as is necessary shall be removed and a new invert shall be constructed to accommodate both new and existing flows. All work shall conform to the requirements specified for new manholes. The existing structure connection shall be cored and a flexible watertight connection (i.e., boot) installed. The boot shall be installed in accordance with Public Works Commission standard details and requirements. The Contractor shall coordinate and cooperate with the Public Works Commission's Project Coordinator.

PIPE TO MANHOLE CONNECTOR (BOOT)

A watertight, flexible pipe-to-manhole connector shall be utilized on all pipe to manhole connections, for both new and existing manholes and pipes, unless otherwise specifically authorized in writing by the Public Works Commission.

The connector assembly shall be the sole element to provide a watertight seal of the pipe to the manhole or other structure. The connector shall consist of a rubber gasket, an internal compression sleeve, and one or more external take-up clamps. The connector shall consist of natural or synthetic rubber and Series 300 non-magnetic stainless steel. No plastic components shall be allowed.

The rubber gasket shall be constructed of synthetic or natural rubber, and shall meet or exceed the requirements of ASTM C-923. The connector shall have a minimum tensile strength of 1,600 psi. The minimum cross-sectional thickness shall be 0.275 inches.

The internal expansion sleeve shall be comprised of Series 300 non-magnetic stainless steel. No welds shall be utilized in its construction.

Installation of the connector shall be performed utilizing a calibrated installation tool furnished by the connector manufacturer. Installation shall require no re-tightening after the initial installation. Installation shall be done in accordance with the manufacturer's instructions.

The external compression take-up clamps shall be Series 300 non-magnetic stainless steel. No welds shall be utilized in its construction. The clamps shall be installed utilizing a torque-setting wrench furnished by the connector manufacturer. Installation shall be done in accordance with the manufacturer's instructions.

The Contractor shall utilize the proper size connector in accordance with the connector manufacturer's recommendations. All dead-end pipe stubs shall be restrained in accordance with ASTM C-923.

The finished connection shall provide a sealing to a minimum of 13 psi, and shall accommodate a minimum pipe deflection of seven (7) degrees without the loss of seal.

The pipe to manhole connector shall be PSX: Direct Drive as manufactured by Press-Seal, or approved equal.

INSIDE DROP MANHOLE STRUCTURE

Inside manhole drop structures shall be constructed and installed in accordance with Public Works Commission standard details.

CLEANING

Prior to final inspection, all sanitary sewer laterals, mains, and manholes newly installed on the collection system shall be flushed and cleaned. During the flushing operation, the downstream manhole shall be closed with a watertight plug to protect the existing sewer main. All water and debris shall be removed and properly disposed of by the Contractor. This condition shall be maintained until the Public Works Commission issues final acceptance for the project.

TESTING

Completed sewers shall be tested in accordance with the provisions outlined below. The Contractor shall furnish all equipment, labor, materials, and pay all costs associated with the tests performed. The Contractor shall schedule all testing with the Public Works Commission's Project Coordinator, a minimum of 48 hours in advance. The Contractor shall cooperate with the Public Works Commission's Project Coordinator and furnish any needed assistance necessary to complete the required testing.

For annexation and/or retrofit projects: No testing shall be conducted prior to successful completion of the compaction testing.

For all other projects: No testing shall be completed until all utilities are installed, prior to preparation of the road subgrade. The Contractor may elect to perform testing to satisfy them that the sewer utility is installed properly prior to commencing installation of other utilities. However, such testing shall not be construed as acceptance by PWC.

The deflection/mandrel test shall not be performed until a minimum of thirty (30) calendar days after backfill operations are completed and the area graded to final contours. In lieu of waiting thirty (30) calendar days, the Contractor has the option to have an independent testing laboratory verify that compaction has been completed to achieve the maximum density as shown in the detail. The location and elevation of the compaction testing shall be determined reviewed and approved by the Public Works Commission's Project Coordinator. The Contractor shall provide the Public Works Commission with a copy of the density testing results.

Compaction testing shall be done in accordance with Specification Section 02222 – Excavation and Backfilling for Utility Systems.

Vacuum Testing Manholes:

All precast sanitary sewer manholes installed by the Contractor shall be vacuum tested for leakage. This test shall be done in accordance with ASTM C-1244 and in the presence of a Public Works Commission Project Coordinator. The Contractor shall be responsible for providing all the necessary labor, materials, equipment, testing apparatus, and all other incidentals necessary to complete the vacuum test. All testing equipment utilized shall be approved for use in vacuum testing manholes.

Each manhole shall be tested after assembly. All lift holes shall be plugged with an approved non-shrink grout. All lines, including laterals, entering the manhole shall be temporarily plugged. The Contractor should take care to ensure that the pipes and plugs are secure in place to prevent them being drawn into the manhole. The test head shall be placed directly on top of the concrete surface of the manhole following the manufacturer's recommendations, rather than to the cast iron seating ring.

Manholes may be tested either prior to backfill or post backfill at the contractor's option. For pre-backfill testing, a vacuum of 10 inches of Mercury (inches Hg) shall be drawn on the manhole, the valve on the vacuum line of the test head closed, and the vacuum pump shut off. The time shall be measured for the vacuum to drop to 9 inches of Mercury (inches Hg). The manhole is acceptable if the time for the vacuum reading to drop from 10 inches of Mercury to 9 inches of Mercury meets or exceeds the values indicated below:

<u>Manhole Depth</u>	Diameter of Manhole		
	<u>4' Diameter</u>	<u>5' Diameter</u>	<u>6' Diameter</u>
10' or less	25 sec	33 sec	41 sec
11' to 15'	38 sec	49 sec	62 sec
16' to 20'	50 sec	65 sec	81 sec
21' to 25'	62 sec	82 sec	101 sec
25' to 30'	74 sec	98 sec	121 sec

Vacuum testing backfilled manholes is not recommended in the presence of groundwater. Vacuum testing a backfilled manhole that is subjected to hydrostatic pressure may exceed the design limits of the flexible connectors and could lead to failure of the structure, joints, and/or connectors. Where groundwater is present a reduction in the vacuum pressure applied to the manhole will be required. The vacuum shall be reduced by 1 inch of Mercury for every 1 foot of hydrostatic head between 12 feet and 21 feet. A vacuum test should not be performed when the hydrostatic head exceeds 22 feet. See the chart below:

Hydrostatic Head (ft)*	12	13	14	15	16	17	18	19	20	21	22
Vacuum Pressure (in Hg)	10	9	8	7	6	5	4	3	2	1	**

*Hydrostatic head above the critical connector (critical connector is bottom most flexible connector)

**Do not perform vacuum test

If the manhole fails the initial test, the manhole shall be repaired by an approved method until a satisfactory test is obtained. All repair methods shall be approved by the Public Works Commission prior to being utilized. Retesting shall be performed until a satisfactory test is accomplished.

Mandrel Testing:

Deflection tests shall be performed on all PVC pipe installations. PVC pipe's maximum deflection after backfilling shall not exceed five (5) percent. The rigid ball or mandrel used for the deflection test shall have a diameter not less than 95 percent of the base inside diameter or average inside diameter of the pipe depending on the type of pipe manufactured and the applicable ASTM Standard. The PVC pipe shall be measured in compliance with ASTM D2122 "Standard Test Method of Determining Dimensions of Thermoplastic Pipe and Fittings". The Contractor shall supply all labor, equipment and materials necessary to perform the test in the presence of the Public Works Commission's Project Coordinator. The test shall be performed without mechanical pulling devices. The mandrel shall be constructed so as to preclude any yield in diameter, and with a pull line on each end to facilitate withdrawal. If the deflection exceeds the allowable, the Contractor shall remove and replace the pipe.

Air Testing:

Air testing shall be performed on all mains and laterals to determine acceptability. The length of sewer subject to an air test shall be the distance between two adjacent manholes. The tests shall be conducted in accordance with the appropriate ASTM standard. The air test shall be

coordinated with the Public Works Commission. The Contractor is required to supply all equipment, labor, materials and pay all costs associated with the test performed.

Air Test for PVC Pipe

The low pressure air test on PVC pipe shall be performed with satisfactory results in accordance with ASTM F1417 "Standard Test Method for Installation Acceptance of Plastic Gravity Sewer Lines Using Low-Pressure Air". The pipe, including lateral assemblies, shall be plugged and air added slowly until the internal pressure of the line is raised to 4.0 psi. After the pressure of 4.0 psi is obtained, regulate the air-supply so that the pressure is maintained between 3.5 and 4.0 psi for at least two (2) minutes, depending on air/ground temperature conditions. The pressure will drop slightly until equilibrium is obtained; however, a minimum of 3.5 psi is required. Once the 3.5 psi is maintained, the test will begin. If the pressure drops 1.0 psi within the time indicated below, the test fails.

Pipe Dia (in)	Minimum time (minutes)	Length for Min Time (ft)	Time for Longer Length (sec)
4	3:46	597	0.380L
6	5:40	398	0.854L
8	7:34	298	1.520L
10	9:26	239	2.374L
12	11:20	199	3.418L
15	14:10	159	5.342L
18	17:00	133	7.692L
21	19:50	114	10.470L
24	22:40	99	13.674L
27	25:30	88	17.306L
30	28:20	80	21.366L
33	31:10	72	25.852L
36	34:00	66	30.768L

The Contractor shall observe all safety precautions to include allowing no one in the manholes during testing, securing all plugs and providing additional plug bracing. The Contractor shall be required to furnish, install and remove after testing at no additional cost, a temporary glue cap/plug to be airtight for all cleanout stacks to accomplish air testing. The air pressure shall never exceed 8 psi. All gauges shall be accessible outside of the manholes.

HYDROSTATIC TESTS

After the ductile iron sewer pipe has been laid within the "protected" area and backfilled to finished grade, the pipe shall be subjected to a hydrostatic pressure test. All laterals within the "protected" area shall be ductile iron. All sewers subject to hydrostatic testing shall include (1) sewers entering or crossing streams, (2) sewers located less than 100 feet from any public or private water supply source including any WS-I waters or Class I or Class II impounded reservoirs, (3) where the minimum 18 inch vertical and 10 feet horizontal separation cannot be maintained between sewers and water mains (see NC DENR Regulations), or (4) as specified and/or indicated on the drawings. The Contractor will furnish all labor and material, including test pumps, plugs, and all other incidentals for making hydrostatic tests. Hydrostatic pressure testing shall be conducted on the completed main, including the laterals.

The duration of the pressure test shall be at least one hour or longer, as directed by the Public Works Commission. The hydrostatic pressure shall be 150 psi. Each section of pipe shall be slowly filled with water and the specified test pressure based on the elevation of the lowest point of the line or section under test and corrected to the elevation of the test gauge, shall be applied by means of a pump connected to the pipe in a manner satisfactory to the Public Works Commission. Before applying the specified test pressure, all air shall be expelled from the pipe.

All joints showing visible leaks shall be made tight. Cracked or defective pipe, joints, laterals, and fittings discovered in consequence of the pressure test shall be removed and replaced with sound material, and the test shall be repeated until the test results are satisfactory. The requirement for the joints to remain exposed for the hydrostatic test may be waived by the Public Works Commission in certain situations. The test shall be repeated until satisfactory to the Public Works Commission.

The results of the pressure tests shall be satisfactory as specified. All replacement, repair, or retesting shall be accomplished by the Contractor. All repairs shall be reviewed and approved by the Public Works Commission prior to backfill. The use of couplings, sleeves, etc. shall be reviewed and approved by the Public Works Commission prior to use.

**DIVISION 2
SITE WORK
02750 - WASTEWATER FLOW CONTROL**

GENERAL

The intent and purpose of these specifications is to provide wastewater flow control, i.e., bypass pumping, of the sanitary sewer flows during the Contractor's operations. The Contractor shall furnish all labor, materials, accessories, equipment and tools for performing all operations required to bypass pump sewage around a manhole or sewer section in which work is to be performed.

The Contractor shall provide all pumps, piping, and other equipment to accomplish this task; perform all construction; obtain all permits; pay all costs; and perform complete restoration of all existing facilities to equal or better condition to the satisfaction of Fayetteville Public Works Commission. The Contractor shall be responsible for the design, installation, operation, and maintenance of the temporary bypass pumping system. The Contractor shall provide sufficient documentation to Fayetteville Public Works Commission to demonstrate that he, or his designated subcontractor, have the experience in the design, installation, and maintenance of temporary bypass pumping systems.

RELATED SECTIONS

- A. Section 02305 – Pipe Bursting
- B. Section 02500 – Traffic Control
- C. Section 02730 – Sanitary Sewer System
- D. Section 02760 – Television Inspection
- E. Section 02766 – Sewer Line Cleaning
- F. Section 02780 – Cured-in-Place Lining

REQUIREMENTS

The Contractor shall be responsible for all aspects of the bypass operation, including but not limited to: providing access to install, move, and maintain the pumps in the proper position, traffic control, installation and removal of bypass equipment, pump monitoring, testing of the bypass system, re-fueling, maintenance, notification of property owners (should access to private property be necessary), wastewater and fuel spill containment, and removal and replacement of manhole cones (if necessary). The bypass system (pumps and piping) shall be monitored by Contractor personnel at all times, when the bypass operation is in effect.

The Contractor shall have all materials and equipment on site to immediately respond to any emergencies or other event that could impact the bypass system (i.e., leak in the discharge piping, pump failure, flooding, etc.). The Contractor shall have sufficient support staff and equipment to mobilize to repair and/or service any equipment within one (1) hour of notification,

24 hours a day, seven (7) days a week. In the event of an emergency, the Contractor shall provide an immediate response and fully cooperate with Fayetteville Public Works Commission.

The Contractor shall install the bypass pumps, equipment, and discharge lines to minimize impacts to the property owners, residents, and environment. The Contractor shall be responsible for determining the best location for the bypass equipment, to include, but not limited to, the need for any special provisions to ensure access for the customers, preventing the pumps and manholes from flooding, etc. Such special provisions include, but are not limited to: installation of ramps, excavation and burial of the bypass lines, temporary fencing, sandbagging, construction of berms, raising the pumps, etc. The Contractor bears all

responsibility for the maintenance and restoration of any trenches, ramps, access, etc. necessary for the temporary bypass pumping operation.

The Contractor shall take appropriate steps to ensure that all pumps, piping and hoses that carry raw sewage are protected from traffic. The Contractor shall identify the proposed methods to protect the temporary bypass pumping system from traffic as part of the detailed temporary bypass pumping plan. Traffic control shall be performed in accordance with these Contract Documents.

The bypass pumping system shall be monitored by Contractor personnel at all times (24 hours a day, 7 days a week), when the bypass operation is in effect. The Contractor's personnel shall be on-site at all times (24 hours a day, 7 days a week), and stationed at the primary bypass pumps. Depending on the location and system set-up, it may be necessary for the Contractor to station personnel at each of the various bypass pump locations. Unless otherwise approved by Fayetteville Public Works Commission, one (1) person cannot monitor multiple bypass pump locations. All bypass pumps, regardless of their location (primary or on secondary lines), shall be equipped with an automatic dialer (or other similar device). The Contractor personnel shall immediately respond to any issue regarding the temporary bypass pumping system. All temporary bypass piping shall be periodically monitored (patrolled from pumps to discharge), but no less frequently than once every 12 hours. The bypass pumping equipment shall be automated and capable of functioning without the assistance of an operator.

SUBMITTALS

All submittals shall be provided in accordance with these Contract Documents, and the requirements outlined herein. The Contractor shall submit a detailed bypass pumping plan to Fayetteville Public Works Commission for approval, prior to initiating the bypass operation. The Contractor shall submit this information far enough in advance to allow sufficient time to complete the necessary coordination, including but not limited to obtaining permits (i.e., encroachments), getting permission from property owners to cross and/or utilize their property, and gaining any necessary regulatory approvals. Failure to submit a complete and comprehensive bypass pumping plan in a timely manner shall not be cause for any extension of the Contract Time.

The detailed temporary bypass pumping plan shall include the following information:

- Method of monitoring the pumps to ensure proper operation, to include method of notifying personnel (Fayetteville Public Works Commission and Contractor) in the event of an emergency, activation of back-up pumps, etc.

- Method of monitoring upstream system levels to ensure surcharging does not result in back-ups into buildings, overflows, etc.
- The amount, if any, of any required surcharging.
- Method to initiate back-up pumps.
- Map showing general location of the pumps and bypass lines. This shall include means to maintain access to driveways, etc.
- Measures to secure the bypass system (lines, pumps, etc.) from traffic, vandalism, high stream flows, etc.
- Method of plugging (and securing the plug(s)) and type of plugs.
- Size and location of manholes or other access points for suction and discharge piping.
- Size of pipeline(s) or conveyance system(s) to be bypassed.
- Number, size, material, location, and method of installation of suction piping.
- Number, size, material, location, and method of installation of discharge piping.
- Bypass pump sizes, capacities, and number of each size to be provided on-site, including all primary, secondary, and spare pumping units.
- Calculations of static lift, friction losses, minimum inlet submergence, and flow velocity (pump curves showing pump operating range shall be submitted). Calculations shall be signed and sealed by a licensed Professional Engineer registered in the State of North Carolina. Calculations shall be provided for both the peak flow rate and a normal daily rate (see PUMPING AND BYPASSING section for sizing requirements).
- Measures to protect discharge manhole(s) or structure(s) from erosion and damage due to the bypass operation.
- Erosion control measures.
- Emergency contact information for the personnel responsible for the pump operation.
- Emergency contact information for Contractor personnel to respond in the event of an emergency.
- List of available resources (equipment, materials, personnel) and contact information for emergency response.
- Method to contain potential releases of sewer flow from air release valves.

· Contingency plan for responding to potential sewer spills caused by weather, vandalism, acts of God, etc. The plan shall include communication protocols, available resources, and the steps to be taken in the event of an emergency.

No bypass operations shall proceed until all bypass submittals have been reviewed and approved by Fayetteville Public Works Commission.

COORDINATION

The Contractor shall fully coordinate their temporary bypass pumping operations with Fayetteville Public Works Commission. It is the Contractor's responsibility to fully determine the scope and location of the temporary bypass pumping system. As outlined in these Contract Documents, Fayetteville Public Works Commission may provide assistance with the building and maintenance of access roads, clearing of easements, etc. All coordination (to include location of the pumps and discharge lines) shall be fully discussed and agreed to prior to commencement of bypass operations.

The Contractor shall schedule a coordination meeting with Fayetteville Public Works Commission and other personnel (Contractor, bypass sub-contractor, etc.) a minimum of three (3) business days prior to starting the temporary bypass pumping system. The purpose of this coordination meeting is to ensure that the Contractor and their sub-contractors have a good understanding of the requirements and expectations of operating the temporary bypass pumping system, discuss contingency plans (to include protocols for emergency contacts), identify location(s) of pumps, verify necessary materials (repair sleeves, containment devices, etc.) are on-site and available, and any other items necessary to ensure that Fayetteville Public Works Commission has confidence that the appropriate personnel can operate and maintain the temporary bypass pumping system. Should, for any reason, Fayetteville Public Works Commission deem that the Contractor and/or their sub-contractor is not prepared to operate and maintain the temporary bypass pumping system, the temporary bypass pumping system shall not be started. The Contractor shall take all necessary steps to address any concerns to the satisfaction of Fayetteville Public Works Commission. Upon completion of those actions, another coordination meeting shall be held, in order for Fayetteville Public Works Commission to confirm that the Contractor and their sub-contractor is prepared to operate and maintain the temporary bypass pumping system. This process will be repeated until Fayetteville Public Works Commission is satisfied that the Contractor and their sub-contractor are prepared to operate and maintain the temporary bypass pumping system. No additional contract time will be granted for this delay.

The temporary bypass pumping system shall run for a minimum of 24 hours, or longer as deemed by Fayetteville Public Works Commission, prior to any activity occurring (cleaning, closed circuit television {CCTV}, etc.) within the main(s) being bypassed.

FLOW CONTROL PRECAUTIONS

Where the raw sewage flow will be blocked during the Work as a result of the temporary bypass pumping operation, the Contractor shall take all necessary precautions to protect the public health. No septic conditions shall be allowed due to Contractor's operations. The sewer system (mains, manholes, laterals, etc.) shall also be protected from damage. The following occurrences shall not be allowed:

1. No sewage shall be allowed to back up into any homes or buildings.
2. No sewage shall overflow any manholes, cleanouts or any other access to the sewers.
3. Users upstream of the project area shall be able to use all their water and sewer utilities without interruption or limitations.

If any of the above occur or are expected to occur, the Contractor shall take immediate action to alleviate one or all of the conditions. Additionally, the Contractor is required to observe the conditions upstream of the plug and be prepared to immediately increase bypass pumping or release the flows, as required. Any damage claims resulting from the Contractor's failure to properly maintain sewer flows shall be the Contractor's responsibility.

All sump pumps, bypass pumps, trash pumps or any other type pump which pulls sewage or any type of material out of the sanitary sewer system shall discharge into another sanitary sewer manhole, or appropriate vehicle or container acceptable to Fayetteville Public Works Commission. Under no circumstances shall untreated sanitary sewer be discharged, stored or deposited on the ground, swale, road or open environment. The Contractor shall not allow any flow of sewage onto private property, streets, or into creeks and drainage systems. Damage due to negligence of the Contractor, including, but not limited to, flooded dwellings, damaged property, damaged driveways, etc., shall be corrected immediately by the Contractor at no additional cost to Fayetteville Public Works Commission.

PLUGGING AND BLOCKING

In some applications, the wastewater flow may be plugged and contained within the capacity of the collection system. This shall only be done when it has been determined the system can accommodate the surcharging without any adverse impact. The Contractor has the sole responsibility for determining whether the system can accommodate surcharging. If this option is selected, the Contractor shall be responsible for continuously monitoring the system to ensure no sewer spills or overflows occur.

A sewer line plug shall be inserted into the line at a manhole upstream from the section being surveyed or repaired. The plug shall be so designed that all or any portion of the operation flows can be released. The Contractor shall secure the plug, to prevent it from being dislodged and moving downstream. Flows shall be bypassed for the initial CCTV inspection and shall be bypassed throughout the duration of the work, to include the final CCTV inspection. Flows shall be bypassed in accordance with the approved temporary bypass pumping plan. Upon acceptance of the work by Fayetteville Public Works Commission, the temporary bypass pumping system shall be removed and flows restored.

PUMPING AND BYPASSING

The Contractor, when and where required, shall divert sewer flows for the sewer pipe rehabilitation process, cleaning, television inspection, pipe repairs, manhole replacement and/or rehabilitation, obstruction removals, or other related as required to complete the Work. The pumps and bypass lines shall be of adequate capacity and size to handle and prevent backup or overflow for all flows.

The temporary bypass pumping system shall be designed to maintain the flows necessary to meet the requirements of each particular location. The temporary sewer bypass system shall have the capacity to handle the flows outlined in these Contract Documents. The temporary sewer bypass system shall be sized to handle 2.5 times the average daily flow rate, or the specified peak flow – whichever is greater.

The Contractor shall be responsible for furnishing the necessary labor and supervision to set up, operate, and maintain the temporary bypass pumping system. A “set up” consists of the necessary pumps, conduits and other equipment to divert the flow of sewage, from the start to finish of work performed. Each “set-up”, regardless of location, shall have Contractor personnel on-site at all times (24 hours a day, 7 days a week) and stationed at the pumps, unless otherwise approved by Fayetteville Public Works Commission. The temporary bypass pumping system shall include:

- A minimum of one (1) redundant pump so that the temporary bypass pumping system is capable of transmitting the peak flow with the largest duty pump out of service.
- Pumps shall be provided with a means of automatic control via level sensing. Systems requiring manual starting and/or stopping shall not be allowed.
- All equipment (primary and secondary pumps) shall be equipped in a manner to keep noise to a maximum of 65 dBA at 30 feet.
- An automatic dialer (or similar) to immediately notify (in a sequential operation) Contractor and Fayetteville Public Works Commission personnel in the event of equipment failure. The automatic dialer shall be set to issue notifications prior to flow level reaching critical elevations and having a spill occur. All bypass pumps (regardless of location) shall be equipped with an automatic dialer (or similar).

The temporary bypass pumping system shall be provided in such a way as to maintain access for businesses and residences. The Contractor shall be responsible for determining the best location for the bypass equipment, and the need for any special provisions to ensure access for the residents and businesses. Such special provisions include, but are not limited to: installation of ramps, excavation and burial of the bypass lines, etc. The Contractor shall use bridges over the bypass lines, temporary lines under driveways, alternate routes, or other means to accomplish this item. The bypass plan submittal shall indicate the means of maintaining access. The Contractor bears all responsibility for the maintenance of any trenches, ramps, etc. necessary for the bypass operation.

Pumps, equipment, and bypass lines shall be continuously (24 hours a day, 7 days a week) monitored by on site Contractor personnel capable of starting, stopping, refueling and maintaining these pumps during the Work. The temporary bypass pumping system shall be provided with an automatic dialer (or other similar device) that will immediately notify (in a sequential operation) the Contractor and Fayetteville Public Works Commission in the event of equipment failure. All bypass pumps (regardless of location) shall be equipped with an automatic dialer. This automatic dialer (or similar) shall be set to issue notifications prior to flow levels reaching critical elevations and having a spill occur.

The automatic dialer shall be set to issue notifications through a sequential operation. Automatic dialers that are not set up for sequential notifications shall not be acceptable. The Contractor's

personnel shall be the first to receive any notifications from the automatic dialer. The automatic dialer shall only notify the PWC personnel after all Contractor notifications have been ignored and/or not responded to. The Contractor shall properly adjust the level at which the automatic dialer initiates notification to provide adequate time for the sequential notification to occur. If the PWC personnel are notified by the automatic dialer, the PWC personnel shall assume that a spill is occurring or is imminent, and respond accordingly. The Contractor shall be responsible for all costs for the PWC to mobilize and respond to the notification, regardless if a spill occurred or not.

In some applications, it may be necessary to surcharge the system in order to ensure proper pump operation. This shall only be done when it has been determined the system can accommodate the surcharging without any adverse impact. The Contractor has the sole responsibility for determining whether the system can accommodate surcharging. In the event surcharging is necessary, the Contractor shall be responsible for continuously monitoring the system to ensure no sewer spills occur.

All bypass piping shall successfully pass a hydrostatic test prior to bypassing the sewer flows. The hydrostatic test pressure shall be no less than the expected discharge pressures, and shall be held for a minimum of one (1) hour. All testing shall be observed by Fayetteville Public Works Commission. Testing shall be coordinated with Fayetteville Public Works Commission a minimum of 24 hours in advance.

SPILL RESPONSE

The Contractor shall not discharge or pump any sewage, solids, or debris on the ground, streets, storm water system, ditches, or streams. Any sewage spills shall be immediately reported to Fayetteville Public Works Commission Water Resources Construction Department, (910) 223-4716. After normal business hours, the Contractor shall contact Fayetteville Public Works Commission Dispatch Center, (910) 678-7400 or (910) 323-0178. The Contractor shall take complete responsibility for all costs related to the clean-up of the spill, including any fines issued by the North Carolina Department of Environmental Quality (NC DEQ).

In the event that raw sewage (in any quantity) is spilled, discharged, leaked or otherwise deposited in the open environment, due to the Contractor's work, the Contractor is responsible for any cleanup of solids and disinfection of the area affected. This work will be performed at the Contractor's expense with no additional cost to Fayetteville Public Works Commission. The Contractor is also responsible for complying with any and all regulatory requirements in regards to the size spill with no additional cost to Fayetteville Public Works Commission. The Contractor shall cooperate fully with Fayetteville Public Works Commission and the applicable State agencies in responding to and cleaning up the spill. Any work completed by Fayetteville Public Works Commission in responding to a spill caused by the Contractor's operations shall be billed to the Contractor.

Where sewage has backed up into a property due to any aspect of the Contractor's operation, the Contractor shall immediately notify Fayetteville Public Works Commission, inspect the property with Fayetteville Public Works Commission and agree on remedial measures. The Contractor shall be responsible for all cleaning, repair and/or replacement of damaged property, temporary relocation of all occupants of the affected properties, if required, all to the satisfaction of the property owner. These actions shall be undertaken immediately upon learning of the backup. Cleaning shall be performed by firms specializing in this type of work. All costs

associated with the cleaning, repair, replacement of damages, occupant accommodations, insurance and spill remediation shall be borne by the Contractor. All remediation measures required as part of a spill response are part of acceptance of the project, and final payment shall not be made until such time all required measures are addressed and approved by the appropriate regulatory agency.

**DIVISION 2
SITE WORK
02760 – TELEVISION INSPECTION**

GENERAL

The intent and purpose of these specifications is to visually inspect, by means of closed-circuit television, designated sewer line sections. The Contractor shall furnish all necessary labor, materials, equipment, services, and incidentals necessary to perform the inspection. Items required to be furnished include, but are not limited to, recording and playback equipment, materials, and supplies.

The inspection shall be performed on one sewer section (i.e., manhole to manhole) at a time. The section being inspected shall be suitably isolated from the remainder of the sewer system.

Video recordings of the inspections shall be made, and copies of both the video and printed inspection logs shall be furnished to Fayetteville Public Works Commission. Each segment of sewer shall be inspected prior to installation of the rehabilitation method and upon completion of installation. All inspections shall be completed by a PACP certified operator.

The Contractor may have to perform cleaning, remove protruding taps, or remove roots and/or other obstructions to complete the video inspection of the pipe prior to rehabilitation.

RELATED SECTIONS

- A. Section 02766 – Sewer Line Cleaning
- B. Section 02730 – Sanitary Sewer System
- C. Section 02780 – Cured-in-Place Lining
- D. Section 02305 – Pipe Bursting

EQUIPMENT

The television camera used for the inspection shall be one specifically designed and constructed for such inspection. Lighting for the camera shall be suitable to allow a clear picture for the entire periphery of the pipe. The camera shall be operative in 100 percent humidity conditions. The camera, television monitor, and other components of the video system shall be capable of producing a minimum 500-line resolution video picture. Picture quality and definition shall be to the satisfaction of Fayetteville Public Works Commission, and if unsatisfactory, inspection shall be performed again with the appropriate changes made as designated by Fayetteville Public Works Commission, at no additional cost. The television inspection equipment shall have an accurate footage counter that shall display on the monitor, the exact distance of the camera from the centerline of the starting manhole.

PROCEDURE

The camera shall be moved through the line in either direction at a uniform rate, stopping when necessary to ensure proper documentation of the sewer’s condition, but in no case will the television camera be pulled at a speed greater than 30 feet per minute. Manual winches, power winches, TV cable, and powered rewinds or other devices that do not obstruct the camera view or interfere with proper documentation of the sewer conditions shall be used to move the camera through the sewer line. If during the inspection operation, the television camera will not pass through the entire sewer line section, the equipment shall be removed and

repositioned in a manner so that the inspection can be performed from the opposite manhole. If, again, the camera fails to pass through the entire section, the Contractor shall remove or cut protruding service connections or re-clean or further remove roots or blockage.

Whenever non-remote powered and controlled winches are used to pull the television camera through the line, telephones, radios, or other suitable means of communication shall be set up between the two manholes of the sewer line being inspected to ensure that good communications exist between members of the crew.

The camera height shall be adjusted such that the camera lens is always centered (at one-half the ID) in the pipe being inspected. Flow shall be controlled such that the following requirements are met:

A. For the initial television survey, before and after a lining is installed, the sewer line shall be blocked completely. No flow, except infiltration/inflow, will be allowed through the respective sewer line being televised on the pre-repair television survey, and the post repair television survey.

B. For all other television surveys, including warranty surveys and joint testing and sealing, the depth of flow within the sewer shall not exceed that shown below for the respective pipe sizes as measured in the manhole.

1. Maximum Depth of FlowJoint Testing/Sealing

6" - 10" Pipe.....20% of pipe diameter

12" - 24" Pipe.....25% of pipe diameter

Above 24" Pipe30% of pipe diameter

2. Maximum Depth of FlowJoint Testing/Sealing

6" - 12" Pipe.....25% of pipe diameter

15" - 24" Pipe.....30% of pipe diameter

Above 24" Pipe35% of pipe diameter

The lighting system shall be adequate to ensure quality pictures.

RECORD OF VIDEO AND LOGS

A. Television Inspection Logs

Printed location records shall be kept which shall clearly show the location, in relation to adjacent manholes of each source of infiltration discovered. In addition, other data of significance, including locations of service connections, along with an estimation of infiltration from such services, joints, unusual conditions, roots, storm sewer connections, cracked or collapsed sections, presence of scale and corrosion, sewer line sections that the camera failed to pass through and reasons for the failure and other discernible features shall be recorded and a copy of such records shall be furnished to Fayetteville Public Works Commission. All identification of defects within the sewer main shall be in accordance with PACP standards.

B. Video Recordings

The purpose of recording the television inspection is to supply a visual aid and audio record of problem areas of the lines that may be re-played by Fayetteville Public Works Commission. Video recording playback shall be at the same speed that it was recorded. All video recordings shall be in color. Initial pre and post video recordings shall be supplied in a standard digital video file format (i.e. mp4, mpg, or avi) and supplied on standard portable USB Hard Disk Drive as approved by Fayetteville Public Works Commission.

The Contractor shall furnish digital videos and logs of the pre and post video inspections to Fayetteville Public Works Commission at each of the monthly progress meetings. The Contractor shall pre-screen the videos and note any areas of concern, including, but not limited to: protruding taps, potential point repairs, excessive infiltration at the laterals, and poor lateral conditions that could pose problems with reinstatement after lining. The Contractor shall provide Fayetteville Public Works Commission with a minimum of two weeks notice for any potential repairs that are necessary to proceed with the work.

At the completion of each task order, the Contractor shall provide Fayetteville Public Works Commission with digital media containing the pre and post videos for all work completed during that task order. Digital files and folders contained with the media shall be descriptively named and organized, and each unique video shall be a separate digital file. All media shall be labeled as to its contents. Labels shall include the disc number (if using DVD), date televised, sewer segment reach designation, street location, and manhole numbers. The digital media shall be provided to Fayetteville Public Works Commission within 30 days of completing the work authorized in the task order.

**DIVISION 2
SITE WORK
02763 - MANHOLE LINING – FIBERGLASS REINFORCED EPOXY**

GENERAL

The Contractor shall furnish all labor, materials, equipment and incidentals required and install the monolithic fiberglass reinforced epoxy manhole lining system and appurtenances as specified herein. The lining system shall be used to rehabilitate the interior of all designated existing sewer manholes as indicated within these Contract Documents and as shown on the Contract Drawings. The installed lining system shall be a structurally designed liner, meeting or exceeding all specified physical properties. The installed lining system shall withstand all loading conditions and hydrostatic pressure.

The manhole lining system shall consist of a cementitious base coat applied to the cleaned and prepared manhole surfaces, followed by the fiberglass reinforced epoxy lining system. The Contractor shall furnish all necessary materials, labor, and equipment necessary to properly prepare the surfaces and apply the fiberglass reinforced epoxy lining system as specified herein.

The Contractor is responsible for properly preparing the existing manhole for lining prior to the installation of the lining system, including stopping all leaks, flow control, patching voids, removing steps/manhole rungs, cleaning (to include water blasting), removing rubble, root, removal, debris removal, etc.

The Contractor is advised that the presence or absence of any leakage through the manhole walls as seen in the Contractor's independent inspection prior to bidding is dependent upon the ground water levels and conditions at the time of the inspections. The Contractor shall reflect his/her assumptions and judgments on leakage through the manhole walls based on this information in the unit prices bid. All leakage shall be stopped prior to installing the lining system. No additional payment will be made to the Contractor for repairing leaks not visible prior to bidding.

Cleaning, surface preparation, lining application, and thicknesses shall be as specified herein and shall meet or exceed the lining manufacturer's recommendations. When the manufacturer's minimum recommendations exceed the specified requirements, the Contractor shall comply with the manufacturer's minimum recommendations.

RELATED SECTIONS

- A. Section 02500 – Traffic Control
- B. Section 02730 – Sanitary Sewer System
- C. Section 02750 – Wastewater Flow Control
- D. Section 02765 – Manhole Chimney Seals

REFERENCE STANDARDS

This Section contains references to the governing standards and documents listed below. They are a part of this Section as specified and modified; the current version shall apply unless otherwise noted. In case of conflict between the requirements of this section and those of the listed documents, the more stringent of the requirements shall prevail.

A. American Concrete Institute (ACI)

- a. ACI 224.1R – Causes, Evaluation and Repair of Cracks in Concrete Structures
- b. ACI 301 – Specifications for Structural Concrete
- c. ACI 308R – Guide to Curing Concrete
- d. ACI 350 – Code Requirements for Environmental Engineering Concrete Structures and Commentary
- e. ACI 515 – A Guide to the use of Waterproofing, Dampproofing, Protective, and Decorative Barrier Systems for Concrete
- f. ACI 546.R – Concrete Repair Guide
- g. ACI 546.3R – Guide for the Selection of Materials for the Repair of Concrete

B. ASTM International (ASTM)

- a. ASTM C 868 – Standard Test Method for Chemical Resistance of Protective Linings
- b. ASTM C 1583/1583M – Standard Test Method for Tensile Strength of Concrete Surfaces and the Bond Strength or Tensile Strength of Concrete Repair and Overlay Materials by Direct Tension (Pull-off Method)
- c. ASTM D 2794 – Standard Test Method for Resistance of Organic Linings to the Effects of Rapid Deformation (Impact)
- d. ASTM D 4060 – Standard Test Method for Abrasion Resistance of Organic Linings by the Taber Abraser
- e. ASTM D 4285 – Standard Test Method for Indicating Water or Oil in Compressed Air
- f. ASTM D 4263 – Standard Test Method for Indicating Moisture in Concrete by the Plastic Sheet Method
- g. ASTM D 4414 – Standard Practice for Measurement of Wet Film Thickness by Notch Gages
- h. ASTM D 4541 - Standard Test Method for Pull-off Strength of Coatings Using Portable Adhesion Testers
- i. ASTM D 6944 Standard Test Method for Measuring Humidity with a Psychrometer
- j. ASTM D 7682 – Standard Test Method for Replication and Measurement of Concrete Surface Profiles Using Replica Putty
- k. ASTM F 1869 – Standard Test Method for Measuring Moisture Vapor Emission Rate of Concrete Subfloor Using Anhydrous Calcium Chloride
- l. ASTM F 2170 – Standard Test Method for Determining Relative Humidity in Concrete Floor Slabs Using in situ Probes
- m. ASTM F 2414 – Standard Practice for Sealing Sewer Manholes Using Chemical Grouting
- n. ASTM G 210 – Standard Practice for Operating the Server Wastewater Analysis Testing Apparatus

C. International Concrete Repair Institute (ICRI)

- a. Guideline No. 310.1R – Guide for Surface Preparation for the Repair of Deteriorated Concrete Resulting from Reinforcing Steel Corrosion
 - b. Guideline No. 310.2 – Selecting and Specifying Concrete Surface Preparation for Sealer, Linings, and Polymer Overlays
- D. National Association of Corrosion Engineers International (NACE)
- a. NACE Publication 6D-173 – A Manual for Painter Safety
 - b. NACE SP0188 – Standard Practice for Discontinuity (Holiday) Testing of Protective Linings
 - c. NACE SP0892 – Standard Practice for Coatings and Linings over Concrete for Chemical Immersion and Containment Service
 - d. NACE No. 6/SSPC-SP13 – Surface Preparation of Concrete
- E. Occupational Safety and Health Administration (OSHA)
- a. Safety and Health Standards (29 CFR 1910/1926)
- F. The Society for Protective Coatings (SSPC)
- a. SSPC-SP13/NACE No. 6 – Surface Preparation of Concrete
 - b. SSPC-Guide 12 – Guide for Illumination of Industrial Painting Projects
- G. Standard Practice for the Rapid Evaluation of Coatings and Linings by Severe Wastewater Analysis Test (S.W.A.T.)

Unless otherwise specified, references to documents shall mean the documents in effect at the time of receipt of Bids. If referenced documents have been discontinued by the issuing organization, references to those documents shall mean the replacement documents or the last version of the document before it was discontinued.

In case of conflicting requirements between this specification and these referenced documents, the more stringent shall govern.

SUBMITTALS

Submit, in accordance with Section 01300 – Submittals and Section 01000 – Supplementary Conditions, letters, shop drawings, and product data showing materials of construction, installation equipment and details of installation for the monolithic lining system including:

1. Product Data Sheets: Copies of current technical data for each component specified and applied as outlined in this Section.
2. Safety Data Sheets: Copies of current SDS for any materials brought on-site including all clean-up solvents, repair or resurfacing mortars and lining materials.
3. Qualification Data: Approved Installer Training Certificates from manufacturer.
4. Performance Testing Reports: Copies of test data for the entire physical, chemical, and permeation properties listed herein and as outlined within this Section.

5. Installation Instructions: Manufacturer's written installation instructions for the materials specified in this Section.
6. Construction Details: Copies of manufacturer's computer generated standard lining details for specified materials, including: leading edge termination, metal embedment in concrete, joint detail, wall-to-slab detail, pipe termination detail, and any other detail at the request of the Public Works Commission.

GUARANTEE

The installed lining system shall be guaranteed by the Contractor and Manufacturer for a period of five (5) years from the date of final acceptance. During this period, all defects discovered in the lining, as determined by the Public Works Commission, shall be repaired or replaced in a satisfactory manner by the Contractor at no cost to the Public Works Commission. All proposed repairs shall be submitted, reviewed, and approved by the Public Works Commission prior to the Contractor completing any work.

QUALITY ASSURANCE

The Contractor shall be responsible for the provisions of all test requirements specified in the above referenced ASTM Standards as applicable. In addition, all lining products to be installed under this Contract may be inspected at the plant for compliance with these specifications by an independent testing laboratory provided by the Public Works Commission. The Contractor shall require the manufacturer's cooperation in these inspections. The cost of plant inspection of all lining products and materials approved for this Contract shall be borne by the Public Works Commission.

Inspections of the lining products and materials may also be made by the Public Works Commission after delivery. The lining products and materials shall be subject to rejection at any time on account of failure to meet any of the Specification requirements, even though samples may have been accepted as satisfactory at the place of manufacture. Lining materials rejected after delivery shall be marked for identification and shall be removed from the job at once.

The Contractor shall initiate and enforce quality control procedures in accordance with the applicable ASTM, NACE, and SSPC standards, and in accordance with the manufacturer's instructions.

Acceptable Manufacturers: A company with a minimum of five (5) years experience in manufacturing of, and providing technical service for chemical resistant systems equivalent to those specified herein.

The manufacturer of the lining system of manholes shall be a company that specializes in the design and manufacture of corrosion protection systems for manholes. The Contractor shall be completely trained in leak repair, surface preparation, installation of the lining system, and corrosion materials application on manholes. The lining system materials/products shall be suitable for installation in a severe hydrogen sulfide environment without any deterioration.

The Contractor shall be trained and certified by the manufacturer for the handling, mixing, application and inspection of the manhole lining system as described herein.

DELIVERY, STORAGE AND HANDLING

Care shall be taken in shipping, handling and placing to avoid damaging the lining products. Extra care may be necessary during cold weather construction. Any lining product or material damaged in shipment shall be replaced as directed by the Public Works Commission.

Any lining product showing deterioration, or which has been exposed to any other adverse storage condition that may have caused damage, even though no such damage can be seen, shall be marked as rejected and removed at once from the work.

While stored, the lining products shall be adequately packaged and protected. The lining products shall be stored in a manner as recommended by the manufacturer. The Contractor shall comply with the following:

1. Store the materials in sealed, original manufacturer's containers.
2. Store materials in a protected area out of direct sunlight.
3. Keep containers clean and undamaged.
4. Comply with manufacturer's published storage temperature and shelf life recommendations.
5. Protect all materials from freezing.

Deliver products to the job site in manufacturer's original, unopened containers bearing manufacturer's name and label and the following information

1. Product name.
2. Product description (generic product classification).
3. Manufacturer's lot number.
4. Color.

All materials shall be handled in accordance with their Safety Data Sheets (SDS) and the manufacturer's instructions.

PRODUCTS

The materials to be utilized in the lining of manholes shall be designed and manufactured to withstand the severe effects of hydrogen sulfide in a wastewater environment. The manufacturer of corrosion protection products shall have a minimum of 10 years experience in the production of the lining products utilized and shall have satisfactory installation record. All rehabilitation products shall be manufactured by a single manufacturer, or the Contractor shall provide documentation that the materials are compatible with each other.

All lining materials shall be approved by U.S. EPA for sewer system rehabilitation.

The lining system shall be compatible with the thermal condition of the existing sewer manhole surfaces. Surface temperatures will range from 20°F to 100°F.

Any fiberglass reinforced epoxy lining system that cannot provide test results of ASTM G 210 will not be approved for this application. (ASTM G 210– Standard Practice for Operating the Severe Wastewater Analysis Testing Apparatus).

The fiberglass reinforced epoxy lining system shall provide a minimum service life of 50 years.

INFILTRATION CONTROL MATERIAL

Infiltration control materials shall be rapid-setting, high early strength, hand applied cementitious material for stopping infiltrating water and making repairs to concrete, brick or other masonry constructed manholes. The material shall be non-shrinking, non-metallic and non-corrosive. It shall be formulated at the factory and supplied in factory sealed and labeled pre-measured containers. The material shall be compatible with the lining material to be used. The material shall have the following minimum characteristics:

1. Compressive strength (in accordance with ASTM C109):

1 hour	1,000 psi
1 day	2,400 psi
7 day	3,500 psi
28 day	4,500 psi

2. Tensile strength (in accordance with ASTM C-109):

1 day	175 psi
7 day	250 psi
28 day	350 psi

3. Bond Strength (in accordance with ASTM C-321)

30 minutes	50 psi
1 day	85 psi

4. Freeze-Thaw Durability (in accordance with ASTM C-666)

100 cycles	no loss
------------	---------

5. Set Time (in accordance with ASTM C-191-92)

Initial	30 to 60 seconds
Final	1 hour

6. Shrinkage (in accordance with ASTM C-157) – 0%

Infiltration control material shall be CEMTEC Hydraulic Cement by A.W. Cook Cement; Mainstay ML-10 by Madewell Products Corporation; PLS-505 by Protective Liner Systems; Quad-Plug by Quadex; or approved equal.

Chemical sealants or grouts used to seal active manhole leaks, to patch cracks, to fill voids and to otherwise prepare the manhole surfaces for the lining installation shall be suitable for the intended purpose and shall be compatible with the lining system as certified by the manufacturer.

All leaks shall be stopped prior to the installation of the lining system.

PATCHING MATERIAL

Voids in the existing manhole walls, benches, or damaged inverts must be repaired prior to installing the lining system. The patching material shall be a rapid setting, high early strength, corrosion resistant hand mixed and hand applied cementitious material intended for filling voids and repairing inverts in concrete, brick or other masonry constructed manholes. It shall be formulated in the factory and supplied in factory sealed and labeled pre-measured containers.

The material shall be compatible with the lining material to be used. The material shall have the following minimum characteristics:

1. Compressive strength (in accordance with ASTM C109):

1 day	3,500 psi
7 day	4,900 psi
28 day	5,500 psi

2. Tensile strength (in accordance with ASTM C-109):

1 day	200 psi
7 day	250 psi
28 day	550 psi

3. Freeze-Thaw Durability (in accordance with ASTM C-666)

100 cycles	no loss
------------	---------

4. Set Time (in accordance with ASTM C-191-92)

Initial	15 to 20 minutes
Final	20 to 25 minutes

Patching material shall be CEMTEC Rapid Cure Vertical Grade by A.W. Cook Cement; Mainstay ML-72 by Madewell Products Corporation; Hyperform by Quadex; or approved equal.

All voids and other repairs shall be completed prior to the installation of the lining system.

CEMENTITIOUS BASE COAT

The use of a cementitious base coat shall be required for all lining systems. The cementitious base coat shall be a pumpable Portland based 100% pure calcium aluminate cement. The lining shall be installed via trowel or low-pressure application. The materials shall be suitable for all the specified design conditions.

The cementitious base coat shall be a system suitable for use as a trowel- or spray-applied monolithic surfacing in sewer manholes. The cementitious lining system shall be Mainstay ML-CA by Madewell Products Corporation; Aluminaliner by Quadex; CEMTEC Silatec CAM by A.W. Cook Cement; PLS-507 by Protective Liner Systems; or approved equal.

The cementitious base coat shall be applied to the following minimum total thicknesses for all lining systems:

1. **For block and cast concrete manholes in good condition, apply to a minimum thickness of 0.5 inch.**
2. **For all brick manholes and for block or cast concrete manholes in poor condition, apply to a minimum thickness of 1.0 inch.**

It is the Contractor's responsibility to determine the required thickness of the cementitious base coat, based on the manhole condition, groundwater conditions, etc. to ensure the long-term integrity of the installed lining system.

The cementitious base coat shall be installed on the walls of existing manholes, from the invert to the manhole frame, as further directed below. All cementitious lining shall be troweled to consolidate the material, and then brushed to provide a profile surface for application of the polymeric topcoat. The initial trowelling shall be done in an upward motion, to compress the material into voids. The Contractor shall ensure that the cement is not over-troweled. The cured cementitious base coat surface shall be continuous with proper sealing connections to all unsurfaced areas. The Contractor shall take all measures to ensure that the cementitious base coat properly cures. The use of curing compounds is prohibited.

The materials used in the cementitious base coat shall be mixed on site in accordance with the manufacturer's recommendations. Water shall only be added to the materials during the mixing process and prior to material pumping or spray application. No water shall be added at the nozzle.

The cementitious base coat, when cured, shall have the following minimum characteristics at 28 days as measured by the applicable ASTM standards referenced herein:

1. Density (when applied) – 135 pounds/cubic foot, plus/minus 5 pounds/cubic foot
2. Compressive strength (in accordance with ASTM C109):

1 day	2,800 psi
28 day	8,000 psi
3. Bond Strength (in accordance with ASTM C-321)

28 day	1,700 psi
--------	-----------
4. Flexural Strength (in accordance with ASTM C-78)

28 day	1,500 psi
--------	-----------
5. Shrinkage (in accordance with ASTM C-157) – 0%
6. Freeze-Thaw Durability (in accordance with ASTM C-666)

300 cycles	no loss
------------	---------

The cured cementitious base coat shall be continuously bonded to all the brick, mortar, concrete, chemical sealant, grout, pipe and other surfaces inside the sewer manhole.

Where the manhole to be rehabilitated is subject to vehicular traffic, the cementitious lining shall be installed to no closer than one (1) inch below the bottom of the manhole frame so as to avoid transfer of impact loads to the new liner. Where the manhole to be rehabilitated is not subject to vehicular loads, the cementitious liner shall be continuous up to the manhole frame.

FIBERGLASS-REINFORCED EPOXY RESIN LINING SYSTEM

Materials

The manhole lining system shall be a fiberglass-reinforced epoxy resin lining system suitable for use as a monolithic surfacing in sewer manholes. The lining system shall be the PLS-650 PerpetuWall system by Protective Liner Systems, or approved equal.

The fiberglass reinforcing fabric shall be a bonded fabric of Type E glass, having a minimum tensile strength of 500,000 psi; a minimum modulus of elasticity of 10,500,000 psi; and a maximum elongation of 4.8%. The fiberglass reinforcing fabric shall be a stitch-bonded construction with a chemical binder to enhance handling and adhesion. The fiberglass reinforcing fabric shall be PLS-811, as supplied by Protective Liner Systems, or approved equal.

The epoxy resin system shall be a two-component, 100% solids that emits no toxic odors; modified epoxy coating that can be applied to dry, damp, or wet surfaces. The epoxy resin system shall have the following minimum physical properties:

1. Hardness 68-72 Shore D
2. Tensile Strength 12,400 psi
3. Compressive Strength 16,800 psi
4. Flexural Strength 13,900 psi
5. Impact Resistance 160 in-lbs
6. Heat Distortion Temp 220 Degrees F
7. Ultimate Elongation 4.5%

The epoxy resin system shall be PLS-613 EpoxyCoating or PLS-614 EpoxyMastic (also referred to as PerpetuCoat LT or PerpetuCoat) as manufactured by Protective Lining Systems; or approved equal.

The lining system top coat shall be an epoxy polymer protective barrier material specifically designed to protect concrete and steel surfaces in severe wastewater environments, including associated abrasive physical attack and chemical attack from sewer gases and organic acids generated by microbial sources.

The top coat materials shall be hand applied to the minimum dry film thickness of 150 mils.

The epoxy resin materials shall be suitable for sewer system service and chemically resistant to any chemicals or vapors normally found in domestic, commercial, and/or industrial sewage. The epoxy resin materials shall be compatible with the cementitious base coat material, as per manufacturer's recommendations.

Installation

The fiberglass reinforced epoxy lining system shall be installed over the cementitious base coat previously applied on the inverts, benches, and walls of the designated manholes. The fiberglass reinforced epoxy liner shall be applied only after the cementitious base coat has properly cured, in accordance with the manufacturer's instructions.

The Contractor shall saw-cut the existing walls, benches, and/or inverts in order to "tie-in" the fiberglass reinforced epoxy lining.

The cured surface of the fiberglass reinforced epoxy lining system shall be smooth and continuous with proper sealing connections to all unsurfaced areas. The liner shall be troweled to consolidate the product into the profile of the substrate or resurfacing mortar.

When cured, the monolithic fiberglass reinforced epoxy lining system shall form a continuous, tight-fitting, hard, impermeable surfacing which is suitable for sewer system service and chemically resistant to any chemicals or vapors normally found in domestic, commercial, and/or industrial sewage. The fiberglass reinforced epoxy lining shall be continuously bonded to the cementitious base coat.

Where the manhole to be rehabilitated is subject to vehicular traffic, the fiberglass reinforced epoxy lining system shall be installed to no closer than one (1) inch below the bottom of the manhole frame so as to avoid transfer of impact loads to the new liner. In those locations where the manhole is subject to vehicular traffic, a chimney seal shall be installed to "bridge" the gap between the manhole frame and the fiberglass reinforced epoxy lining system. Where the manhole to be rehabilitated is not subject to vehicular loads, the fiberglass reinforced epoxy lining system shall be continuous up to the manhole frame. **The fiberglass reinforced epoxy lining system shall not be applied to the manhole frame.** The Contractor shall ensure that no material is placed on the manhole frame, to allow the locking cover (as applicable) to properly function.

INSTALLATION

GENERAL

All work shall be in accordance with these Contract Documents and as directed by the Public Works Commission.

The Contractor shall comply with all local, State and Federal regulations including those set forth by OSHA, EPA, the Public Works Commission and any other applicable authorities.

Prior to conducting any work, the Contractor shall perform an inspection of the structure to determine the need for protection against hazardous gases or oxygen depleted atmosphere and the need for flow control or flow diversion.

The Contractor shall clean each sewer manhole and shall properly dispose of any resulting material. The Contractor shall take all necessary precautions to not allow any debris from their operations to enter the sewer system. In the event debris or any other material from the Contractor's operation enters the sewer system, the Contractor shall immediately contact the Public Works Commission. The Contractor shall then commence every effort to retrieve the debris. The Contractor shall continue to search for the debris until instructed otherwise by the Public Works Commission.

All surface washing, abrasive blasting, waterjetting, grinding, patching, filling and preparation shall be completed by the Contractor in accordance with the lining system manufacturer's recommendations.

The Contractor shall notify all property owners who discharge sewage directly to the manhole being rehabilitated that their service will be discontinued while the lining system is being installed, cured and active pipe and service connections reopened. The Contractor shall notify

individual property owners at least 48 hours in advance, giving the date, start time and estimated completion time for the work being conducted.

Application procedures shall conform to recommendations of the manufacturer, including materials handling, mixing, environmental controls during application, safety and spray equipment. Material shall not be applied during freezing weather conditions. No material shall be placed when the ambient air temperature is below 40°F, or when the temperature is anticipated to fall below 32°F in the next 24 hours.

Spray equipment shall be specifically designed to accurately ratio and apply the liner system.

SURFACE PREPARATION

Surface preparation methods may include high pressure water cleaning, hydro blasting, abrasive blasting, grinding, detergent water cleaning, and shall be suited to provide a surface compatible for installation of the liner system. Remove all dust, biological growths, grease, oil, paint or any other surface contaminants or coatings from all surfaces to be lined, including manhole walls, corbelling and manhole frame. The choice of surface preparation (including disinfection as necessary) lies solely with the Contractor. The Contractor shall determine the required surface preparation method based upon the condition of the manhole, the presence of potential contaminants, access to perform the work, and the required condition of the surface to apply to specified lining system, as required by the manufacturer.

The surface preparation method shall produce a cleaned, abraded and sound surface with no evidence of laitance, loose concrete, brick or mortar, contaminants or debris, and shall display a surface profile suitable for application of the manhole lining system. The Contractor shall prepare the surface in accordance with the applicable NACE and/or SSPC recommendations for the specified lining system.

Coatings that cannot be removed shall be properly prepared (in accordance with these Specifications) to obtain and insure adequate bonding of the cementitious base coat material.

The Contractor shall conduct a visual inspection of each manhole after it is cleaned. All active infiltration leaks shall be plugged or sealed with an appropriate infiltration control material compatible with the cementitious base coat. The Contractor shall remove all loose mortar and rubble from existing walls, benches and inverts. Repairs to exposed rebar, defective pipe penetrations or inverts, etc. shall be repaired utilizing non-shrink grout or approved alternative method. The Contractor shall prepare manhole to receive the cementitious base coat as necessary by reshaping and repairing benches, inverts, and walls where required. All interior surfaces shall be prepared as recommended by the base coat lining manufacturer. Minimum requirements are as listed below.

1. All cracks and other voids must be repaired and filled with suitable non-shrinking cements, sealants or grouts, including all voids between the existing sewer pipes and manhole walls. Patching compounds shall be compatible with the proposed lining system. All patches shall be smooth and even with the manhole wall.
2. All existing manhole rungs/steps shall be removed and the void patched or cut off and ground smooth.
3. All surfaces shall be suitably prepared for the required bonding of the cementitious base coat as recommended by the manufacturer.

Concrete surfaces to be coated shall be free of curing compounds and form release agents, laitance and foreign particles that may inhibit bonding. Prior to the start of the protective coating system application, the Contractor shall pre-clean as required, and inspect the substrate in accordance with SSPC-SP13/NACE No. 6, Severe Service. Surface preparation procedures shall be in accordance with NACE SP0892, SSPC-SP13/NACE No. 6 and ICRI Guideline No. 310.2. Surface preparation shall expose aggregate and obtain a uniform surface texture resembling the minimum recommended concrete surface ICRI-CSP profile. The Contractor shall remove all dust, biological growths, grease, oil, paint or any other surface contaminants or coatings from all surfaces to be lined, including any metal work to be coated.

Existing Concrete Application: Existing concrete structures to receive the protective coating system must be capable of withstanding imposed loads. All oil, grease, waste and chemical contaminants shall be removed from the surface of the concrete prior to preparation in accordance with NACE SP0892 and SSPC-SP13/NACE No. 6. Concrete surfaces must be sound and capable of supporting the proposed lining system. Surface preparation requirement is to expose a sound, uniform surface texture confirming to the minimum recommended ICRI-CSP. The appropriate cementitious repair mortar or epoxy cementitious repair material shall be applied to the entire, prepared surface to level surface suitable for coating.

Commencement of the Work of this Section shall indicate that the substrate and other conditions of installation are acceptable to the Contractor, and will produce a finished product meeting the requirements of these Contract Documents. All defects resulting from accepted conditions shall be corrected by Contractor at his own expense.

All concrete surfaces shall be prepared to a minimum of SSPC-SP13 prior to installation of the specified lining system.

Level or grind concrete substrates to produce a uniform and smooth surface, including removal of all sharp edges, ridges, form fins, and other concrete protrusions.

FLOW CONTROL

It is the intent of these Contract Documents that the Contractor will utilize flow-through plugs or other means to complete the manhole rehabilitation without the use of a temporary sewer bypass system. All temporary flow-through plugs shall be removed upon the completion of each step of the rehabilitation process (cementitious base coat, polymeric top coat). The Contractor shall be responsible for ensuring that their flow control system does not result in any sanitary sewer being discharged to the environment.

If required to properly complete the lining, the Contractor shall provide temporary bypass pumping of sewage flows where and when the rehabilitation work is being performed. The temporary bypass pumping shall be in accordance with Specification Section 02750 – Wastewater Flow Control and these Contract Documents.

INFILTRATION CONTROL

After surface cleaning, any visible leaks or infiltration shall be stopped, prior to installation of any patching material or the cementitious base coat. Infiltration and leaks shall be stopped utilizing hydraulic cement or other “typical” methods (i.e., oakum). It is the intent of these Contract Documents that the Contractor will take all necessary steps to stop all but the very large leaks without the use of chemical grout. Should a significant, very large leak be encountered that would require significant effort, large quantities of chemical grout, and/or other extreme

measures, the method and cost to stop that leak shall be mutually agreed upon by the Contractor and the Public Works Commission prior to commencing work.

A complete, watertight seal shall be provided at pipe and manhole wall connections. The Contractor shall submit details of how the watertight connections will be made to the Public Works Commission for review and approval.

REPAIR OF BENCHES AND INVERTS

The Contractor shall complete any necessary repairs to the bench and/or invert of the manhole, prior to installation of the specified lining system. All repairs shall be completed in accordance with the requirements of the Public Works Commission, and as outlined herein.

The invert channel shall be constructed of brick and mortar, in accordance with Public Works Commission standard details. The invert channel shall be smooth and semicircular in shape conforming to the inside of the connecting sewer section. Changes in direction of flow shall be made with a smooth curve as large as a radius as the size of the manhole will permit without a decrease in flow velocity. Changes in size and grade of the channel shall be made gradually and evenly. A shelf shall be provided on each side of any manhole invert channel. Inverts in manholes with standing water will not be acceptable.

CEMENTITIOUS BASE COAT

The Contractor shall furnish and place the cementitious base coat in each manhole as and where directed by the Public Works Commission. The installation of the cementitious base coat shall be in complete accordance with the manufacturers' specifications.

Prior to placing the cementitious base coat, the Public Works Commission and the Contractor must inspect and approve the surface preparation work. The Contractor shall notify the Public Works Commission when the manholes are ready for inspection. The Contractor is responsible for ensuring proper installation conditions including surface preparation, temperature, and moisture.

All bottom and horizontal surfaces shall have the cementitious base coat material applied to the required thickness by hand troweling or spray-on methods. All cementitious lining shall be troweled to consolidate the material, and then brushed to provide a profile surface for application of the epoxy resin topcoat. The initial troweling shall be done in an upward motion, to compress the material into voids.

All side vertical surfaces shall have the cementitious base coat applied to the required thickness in one pass or application. Non-vertical surfaces may be completed in multiple passes to prevent sloughing of material.

Temperature limitations must be handled as appropriate and as approved by the manufacturer.

FIBERGLASS-REINFORCED EPOXY RESIN LINING SYSTEM

Prior to placing the epoxy resin lining system, the Public Works Commission and the Contractor must inspect and approve the cementitious base coat. The Contractor shall notify the Public Works Commission when the manholes are ready for inspection. The Contractor is responsible for ensuring proper installation conditions including the cementitious base coat conditions,

temperature and moisture. The cementitious base coat shall be properly cured prior to installation of the lining system.

The Contractor shall install an initial application of the epoxy resin system to a minimum thickness of 100 mils over the previously installed cementitious base coat. Prior to the epoxy resin system setting up, the Contractor shall place the fiberglass fabric over the epoxy resin, and press the fabric into the resin. The fabric shall be fully covered by the epoxy resin. Each section of fabric shall overlap the previous section of fabric a minimum of two (2) inches. Additional epoxy shall be applied at the fabric seams to ensure a monolithic lining system. The fiberglass fabric shall be top coated with the epoxy resin, to ensure complete saturation and encapsulation of the fiberglass fabric.

The finished liner thickness shall be a minimum of 150 mils.

The fiberglass-reinforced epoxy resin lining system shall be applied to all interior manhole surfaces. The Contractor shall saw-cut the existing walls, benches, and/or inverts in order to "tie-in" the fiberglass reinforced epoxy lining system.

All surfaces shall have the lining system applied by a spray-on method or by hand troweled applications to build up to the required thickness.

Temperature limitations must be handled as appropriate and as approved by the manufacturer.

FIELD QUALITY CONTROL

The Contractor to perform the quality control procedures listed below in conjunction with the requirements of this Specification Section.

- A. Inspect all materials upon receipt to ensure that all are supplied by the approved Manufacturer.
- B. Surface pH Testing: The pH of the concrete substrate will be measured using pH indicating papers. The pH testing is to be performed once every 50 square feet. Acceptable pH values shall be a minimum 9.0 as measured using color indicating pH paper with readable color calibrations and a scale at whole numbers (minimum). Use Hydrion Insta-Check Jumbo 1-12, or approved equal. The paper shall be touched to the surface once using moderate gloved finger pressure. The surface shall not be wiped or moved laterally to disturb the surface during pH testing. Following the one touch, lift the paper vertically to not "wipe" the surface. Compare the color indicated with the scale provided and record the pH. Spot check any questionable areas with a 1% phenolphthalein solution. The phenolphthalein solution shall turn bright pink on concrete.

TESTING

During application of the epoxy resin lining system, the Contractor shall measure the thickness and uniformity of the material by the use of a wet film thickness gage meeting the requirements of ASTM D 4414. Measurements shall be completed in the presence of the Public Works Commission. The Contractor shall document all measurements for each manhole and submit the documentation to the Public Works Commission. The documentation shall be submitted with each pay application.

Field acceptance of the manhole lining system shall be based on the Public Works Commission's evaluation of the appropriate installation of the cementitious base coat and fiberglass reinforced epoxy resin system per field inspections and on observation of the installation. Acceptance shall also be based on the Public Works Commission's evaluation of the curing test data and final testing.

The fiberglass reinforced epoxy lining top coat shall provide a continuous monolithic surfacing with uniform thickness throughout the manhole interior and be free of pinholes, slumps and drips. A visual inspection shall be conducted to ensure that no pinholes are in the monolithic coating. The visual inspection shall include terminations and transitions of the installed lining system.

Once the lining system has fully cured, it shall be checked via high voltage spark detection, in accordance with NACE SP0188 and the manufacturer's instructions. All defects shall be corrected at no cost to the Public Works Commission. The high voltage spark detection shall be done in accordance with:

1. The manhole environment shall be properly vented prior to testing to ensure hazardous conditions do not exist.
2. The high voltage spark detection equipment shall be set at 100 volts per one (1) mil of applied film thickness, or as recommended by the manufacturer.
3. All detected holidays shall be marked and the area of the liner shall be repaired. The surface area around the defect in the liner shall first be abraded using an appropriate grit paper or other hand abrasion tool. After abrading and cleaning the area, the area shall be patched by hand application of the fiberglass reinforced epoxy lining topcoat material. All repair procedures shall follow manufacturer's recommended procedures.
4. All repaired areas shall be spark tested.

The Contractor is expected to perform preliminary spark testing prior to scheduling a final test with the Public Works Commission. Any defects noted during this preliminary testing shall be repaired in accordance with these specifications and the manufacturer's recommended procedures.

ACCEPTANCE

The Public Works Commission shall complete a final inspection of each manhole, to include a visual inspection to verify that no leakage through the manhole wall is occurring, the manhole has been rehabilitated in accordance with the Contract Documents, and witness the final spark test. The Public Works Commission shall visually inspect every manhole and shall observe the final spark testing for every manhole. The Contractor shall coordinate with the Public Works Commission to schedule the final inspection. Any deficiencies noted during the final inspection shall be repaired in accordance with these specifications and the manufacturer's recommended procedures.

Inspection by the Public Works Commission does not absolve the Contractor from their responsibility for quality control inspection and testing as specified in these Contract Documents or as required by the manufacturer's instructions.

There shall be no groundwater infiltration or other leakage through the manhole wall after it has been lined. If leakage is found, it shall be eliminated with an appropriate method as recommended by the liner manufacturer and approved by the Public Works Commission. Any

leakage shall be sealed utilizing materials compatible with the lining system, in accordance with the manufacturer's directions, and as approved by the Public Works Commission. The repair materials shall have the same life expectancy of the installed lining system. All repair materials shall be properly cured in accordance with the manufacturer's instructions. The use of curing compounds is prohibited.

All pipe connections shall be open and clear.

There shall be no cracks, voids, pinholes, slumps, drips, uncured spots, dry spots, lifts, delaminations or other type defects in the lining. The fiberglass reinforced epoxy lining shall provide a continuous monolithic surface with uniform thickness throughout the manhole.

If any defective lining is discovered after it has been installed, it shall be repaired or replaced in accordance with the manufacturer's recommendations and in a satisfactory manner to the Public Works Commission. This requirement shall apply for the entire guarantee period.

The Contractor shall demonstrate that the installed lining system does not interfere with the proper sealing and locking (as applicable) of the manhole cover. Upon completion of the spark testing, all manholes shall be locked (if so equipped). For those manholes within paved areas, the Contractor shall apply four (4) dollops of roofing tar to the frame, to eliminate the cover from rattling. The dollops shall be equally spaced around the frame. The Public Works Commission Project Coordinator shall verify that the manholes are secured (locked and/or tarred).

At the completion of the Work, the Contractor shall remove all materials and debris associated with the Work of this Section.

The Contractor shall clean all surfaces not designated to receive the specified lining system. The Contractor shall restore all other work in a manner acceptable to the Public Works Commission.

The installed lining system shall be protected from damage until Final Acceptance of the Work. Any damage to the installed lining system shall be repaired or replaced at the discretion of the Public Works Commission, at no additional cost to the Public Works Commission.

*** END OF SECTION ***

**DIVISION 2
SITE WORK
02765 - MANHOLE CHIMNEY SEALS**

GENERAL

The Contractor shall furnish all labor, materials, equipment, and incidentals required and install the manhole chimney sealing system and appurtenances as specified herein. The internal manhole sealing system shall seal the manhole, from the top of cone up to, and including, the joint between the manhole cone (including all extensions to the chimney area) and the manhole ring. The Contractor shall furnish all necessary materials, labor, and equipment necessary to properly prepare the surface and apply the sealing system. Installation of the sealing system shall be in accordance with these Contract Documents and the manufacturer's recommendations.

All manhole chimney sealing systems shall be installed after the manhole has been relined, unless otherwise directed by the Public Works Commission.

The Contractor shall accurately field measure and size each individual manhole. The Contractor is responsible for performing any and all necessary field measurements, in order to ensure that the sealing system is properly installed in accordance with the requirements of these Contract Documents and the manufacturer.

RELATED SECTIONS

- A. Section 02500 – Traffic Control
- B. Section 02762 – Manhole Lining – Polymeric
- C. Section 02763 – Manhole Lining – Cured-in-Place

REFERENCE STANDARDS

The following American Society for Testing and Materials (ASTM) standards are incorporated by reference into this specification. The latest edition of the reference shall be used.

- A. ASTM D412-06ae2 – Standard Test Methods for Vulcanized Rubber and Thermoplastic Elastomers – Tension
- B. ASTM D2240-97e1 – Standard Test Method for Rubber Property - Durometer Hardness

In case of conflicting requirements between this specification and these referenced documents, this specification will govern.

SUBMITTALS

All submittals shall be provided in accordance with Section 01000 – Supplementary Conditions and Section 01300 – Submittals.

GUARANTEE

All sealing systems installed shall be guaranteed by the Contractor for a period of five (5) years from the date of final acceptance. During this period, all defects discovered in the sealing system, as determined by the Public Works Commission, shall be repaired or replaced in a satisfactory manner by the Contractor at no cost to the Public Works Commission.

QUALITY ASSURANCE

The supplier shall be responsible for the provisions of all test requirements specified in the above referenced ASTM Standards as applicable. In addition, all products to be installed under this Contract may be inspected at the plant for compliance with these specifications by an independent testing laboratory provided by the Public Works Commission. The Contractor shall require the manufacturer's cooperation in these inspections. The cost of plant inspection of all products and materials approved for this Contract shall be borne by the Public Works Commission.

Inspections of the products and materials may also be made by the Public Works Commission after delivery. The products and materials shall be subject to rejection at any time on account of failure to meet any of the Specification requirements, even though samples may have been accepted as satisfactory at the place of manufacture. Materials rejected after delivery shall be marked for identification and shall be removed from the job at once.

The manufacturer and/or applicator of the sealing system shall be a company that specializes in the design, manufacture or installation of corrosion protection systems for manholes. The applicator shall be completely trained in the installation of the sealing system in manholes. The sealing system shall be suitable for installation in a severe hydrogen sulfide environment without any deterioration to the liner.

The applicator shall be trained and certified by the manufacturer for the handling, mixing, application and inspection of the manhole sealing system as described herein.

DELIVERY, STORAGE AND HANDLING

Care shall be taken in shipping, handling and placing to avoid damaging the sealing system products. Extra care may be necessary during cold weather construction. Any sealing system product or material damaged in shipment shall be replaced as directed by the Public Works Commission.

Any sealing system product showing deterioration, or which has been exposed to any other adverse storage condition that may have caused damage, even though no such damage can be seen, shall be marked as rejected and removed at once from the work.

While stored, the sealing system products shall be adequately packaged and protected. The sealing system products shall be stored in a manner as recommended by the manufacturer.

PRODUCTS

SEALING SYSTEM

The materials to be utilized in the sealing of manhole chimneys shall be designed and manufactured to withstand the severe effects of hydrogen sulfide in a wastewater environment. Manufacturer of corrosion protection products shall have long proven experience in the production of the lining products utilized and shall have satisfactory installation record.

Equipment for installation of lining materials shall be high quality grade and be as recommended by the manufacturer.

The manhole seal shall be designed to prevent leakage of water into the manhole through the frame joint area and the area above the manhole cone including all extensions to the chimney area. Extensions shall

include, but are not limited to: concrete adjustment rings, brick, and/or block material that may have been used to achieve grade.

The manhole seal shall remain flexible allowing for the repeated vertical or horizontal movements of the frame due to frost lift, ground movement or the thermal movement of pavements.

The manhole sealing material shall be made no less than 170 mils of corrosion resistant aromatic flexible urethane resin coating to be applied to the inside wall of the entire chimney area as described above.

The product shall have a minimum elongation of 800% and hardness (Durometer) of 75.

The installed sealing system shall have a minimum tensile and adhesion strengths of 1150 psi and 175 lb. l/in. respectively.

The manhole sealing system shall conform to the physical requirements of ASTM D- 412.

The lining product shall have an aromatic urethane primer resin on the complete surface.

The sealing system shall line the interior of the adjustment area from the cone/top of the manhole and onto the inside of the casting.

If the manhole has been relined prior to the seal installation the seal shall cover a minimum of 12 vertical inches, as measured from the casting.

PATCHING MATERIAL

Voids in the existing manhole walls must be repaired prior to installing the manhole chimney sealing system. The patching material shall be a rapid setting, high early strength, corrosion resistant hand mixed and hand applied cementitious material intended for filling voids and making repairs in concrete, brick or other masonry constructed manholes. It shall be formulated in the factory and supplied in factory sealed and labeled pre-measured containers. The material

shall be compatible with the sealing system to be used. The material shall have the following minimum characteristics:

1. Compressive strength ASTM C109 2,000 psi at 24 hours
2. Shrinkage ASTM C 596 0 percent at 90 percent relative humidity
3. Set time ASTM C 191-92 3 to 5 minutes

Product shall be Permacast-Patch as manufactured by Action Products Marketing Corp., Strong-Seal QSR by Strong Company, Preco-Patch by Fosroc Inc. or approved equal.

INSTALLATION

The Contractor shall remove all loose and protruding mortar and brick that would interfere with the sealing system's performance. Any protrusions on the casting shall be cut flush to the casting.

Any voids or repairs to the concrete, brick, or block manhole walls shall be repaired and filled with suitable non-shrinking cements, sealants, or grouts. The patching material shall be compatible with the chimney sealing system. All patches shall be smooth and even with the manhole wall. The Contractor shall allow the patching cement to completely cure prior to beginning installation of the chimney sealing system.

The Contractor shall prepare the surface by sandblasting and utilizing an acetone wet wipe to ensure a clean surface as required by the manufacturer. The substrate surface must be free of sand, loose debris, laitances, dust, oil, grease or chemical contamination. A blower or torch may be required to completely dry the substrate surface or as recommended by manufacturer.

All active, hydrostatic infiltration leaks shall be plugged or sealed with an appropriate grout compatible with the sealing system.

The Contractor shall properly mix the sealing system agents (if necessary), in accordance with the manufacturer's instructions.

The Contractor shall ensure that the casting and structure surfaces are clean and dry, prior to application of the primer. Primer shall be applied in accordance with the manufacturer's instructions.

Once the primer has dried in accordance with the manufacturer's instructions, the sealing system shall be applied to the entire chimney area, to include the frame joint area, the area above the manhole cone, and all extensions in the chimney area. The sealing system shall be installed in accordance with the manufacturer's instructions.

The chimney sealing system shall be as manufactured by Sealing Systems, Inc., or approved equal.

**DIVISION 2
SITE WORK
02766 - SEWER LINE CLEANING**

GENERAL

The intent and purpose of this specification is clean and videos all sewer segments to be rehabilitated. The Contractor shall furnish all labor, materials, equipment, and incidentals necessary to clean all sewer pipe and fittings for each of the identified segments. The cleaning shall be completed prior to the pre-rehabilitation video.

All cleaning shall include the proper high-pressure water jetting, rodding, bucketing, brushing, and flushing of sewers and manholes prior to inspection by closed circuit television, pipeline rehabilitation, and testing operations.

Cleaning shall dislodge, transport, and remove all sludge, mud, sand, gravel, rocks, bricks, grease, roots, sticks, and other debris from the interior of the sewer pipe. The pipe shall be cleaned in such a manner as to ensure the success of the rehabilitation method.

All cleaning operations, as outlined above, shall be included in the Contractor's unit price bid for Sewer Line Cleaning.

RELATED SECTIONS

- A. Section 02760 – Television Inspection
- B. Section 02730 – Sanitary Sewer System
- C. Section 02780 – Cured-in-Place Pipe Lining

EQUIPMENT

A. Hydraulically Propelled Sewer Cleaning Equipment

- a. Hydraulically propelled sewer cleaning equipment shall be the movable dam type, constructed such that a portion of the dam may be collapsed during cleaning to prevent flooding of the sewer.
- b. The movable dam shall be same diameter as the pipe being cleaned and shall provide a flexible scraper around the outer periphery to ensure total removal of grease.
- c. The Contractor shall take precautions against flooding prior to using sewer cleaning balls or other such equipment that cannot be collapsed instantly.

B. High Velocity Hydro-Cleaning Equipment

High velocity hydro-cleaning equipment shall have the following:

- a. A minimum of 800 feet of high-pressure hose.

- b. Two or more high velocity nozzles capable of producing a scouring action from 15 to 45 degrees in all size lines being cleaned.
- c. A high velocity gun for washing and scouring manhole walls and inverts.
- d. Capability of producing flows from a fine spray to a long distance solid stream.
- e. A water tank, auxiliary engines and pumps, and a hydraulically driven hose reel.
- f. Equipment operating controls located above ground.

C. Mechanical Cleaning Equipment

All mechanical cleaning equipment shall be either power buckets or power rodders by the Flexible Tool Division of Rockwell Manufacturing Co, or approved equal.

a. Bucket Machines

- i. Bucket machines shall be furnished with buckets in pairs and with sufficient dragging power to perform the work efficiently.
- ii. Shall use V-belts for power transmission or have an overload device. No direct drive machines will be allowed.
- iii. Shall be equipped with a take up drum and a minimum of 500 feet of cable.

b. Power Rodding Machines

- i. Shall be either sectional or continuous.
- ii. Shall hold a minimum of 750 feet of rod.
- iii. Shall have a rod of specifically treated steel.
- iv. The machine shall be fully enclosed and have an automatic safety throw out clutch.

PERFORMANCE

- A. The Contractor shall utilize properly selected equipment to remove all rocks, dirt, grease, roots, and other deleterious materials and obstructions.
- B. Protect existing sewer lines from damage caused by improper use of cleaning equipment.
- C. The Contractor shall take all necessary precautions to avoid damage or flooding to public and/or private property being served by the line(s) being cleaned.
- D. The Contractor shall utilize the existing sewage flow in the sewer line to provide the necessary pressures for hydraulic cleaning devices whenever possible.

E. Removal of Materials -

a. Remove all solids and semi-solids at the downstream manhole of the section being cleaned.

b. Passing of material from one section to the next downstream section will not be permitted.

F. The Contractor is to remove all materials from the site and properly dispose of all solids and semi-solids recovered during the cleaning operation.

G. No sewer cleaning shall take place in a particular sewer segment until all upstream pipe segments have been cleaned. If cleaning is done in a downstream pipe segment in order to facilitate overall cleaning operations, that segment shall be re-cleaned at no additional cost to the Owner, after all pipes upstream of that segment have been cleaned.

**DIVISION 2
SITE WORK
02831 - CHAIN LINK FENCING**

GENERAL

Where shown on the plans there shall be installed a "chain link" fence with all necessary posts, braces, top rail, gates, fabric, extension arms, and three strand barbed wire.

The erected fence shall meet the following requirements:

The enclosing fence shall have an overall fabric height of six feet (6') and an additional one foot (1') of three strand barbed wire, for a total height of seven (7'). The gates shall be seven feet (7') in overall height.

MATERIALS

Fabric: Fencing shall be chain link #9 gauge aluminized continuously woven wire 2" uniform square mesh without knots or ties, except for knuckling and barbing. Both the top and bottom edges of the fabric shall be barbed unless otherwise shown on the plans. The Contractor shall not piece together a number of short pieces of fence fabric.

Tensile Strength Test: Wire pickets of which this fabric is made to stand a tensile strength test of approximately 70,000 pounds per square inch based on the cross-sectional area of the galvanized wire.

Framework: All posts and other appurtenances used in construction shall be hot-dipped, galvanized with a minimum of 1.8 oz. per square foot surface.

Line Posts: Hot dip galvanized "H" column (2" x 2 1/4") weight 4.1 pounds per linear foot, minimum carbon content 0.355. No used or open seam material will be permitted in posts or rails. (Alternate 2 1/2" O.D. galvanized pipe weight 3.65 pounds per linear foot or C-section line posts of the same dimension as H-post, 0.120 in wall thickness and fabricated from steel conforming to ASTM A-570, Grade E.) Intermediate posts shall be evenly spaced no more than 10 feet apart on center.

Top Rail: Hot dip galvanized pipe 1 5/8" O.D., weight 2.27 pounds per linear foot protected with outside sleeve type couplings at least 7 inches long. No used or open seam material will be permitted.

Terminal Posts: End, corner and pull posts hot dip galvanized pipe 3" O.D. - 5.79 pounds per linear foot. Gate posts hot dip galvanized pipe of "H" construction as specified.

Tension Wire: A bottom tension wire 7 gauge, alzd. (0.4 oz./s.f.), 6 inches above grade. Wire shall be fastened to fabric with aluminum rings at 24" on center and to each intermediate post.

Extension Arms: Hot dip galvanized. Line post arms of pressed steel malleable base; end, and corner post arms of malleable iron; gate posts to have ornamental top. Each extension arm to carry three strands of barbed wire approximately 12 inches out from fence line. Barbed wires to be securely fastened in by means of self-locking grooves. The barbed wire shall support a

minimum of 400 lbs. vertical dead load from tip of arm. The barbed wire shall be 4-point pattern composed of two strands of No. 12 1/2-gauge galvanized wire.

Gates: Frame to be galvanized pipe 2.0 inches O.D. weighing 2.27 pounds per foot. Each frame to be equipped with 3/8-inch diameter adjustable truss rods. Gateposts and corner posts shall be 3 inches O.D. weighing 5.11 pounds per foot. Gates are to be manufactured using 2" aluminum tubing in lieu of the specified Schedule 40 steel pipe. Gateposts and corner posts shall be 6 5/8" O.D. for swing gates (greater than 20 feet in length and 4" O.D. for slide gates, weighing minimum of 5.11 pounds per foot. Corner fittings to be heavy pressed steel or malleable castings. Fabric to be same as in fence. Gates to be completed with malleable ball and socket hinges, catch, stops and rest. Hinges to permit gate to swing back against fence, 180 degrees if required. Latches shall be arranged for padlocking so that the padlock will be accessible from both sides of the gate regardless of the latching arrangement.

Braces: Brace material to be hot dip galvanized and same as top rail, to be spaced midway between top rail and ground, and to extend from terminal post to first adjacent line post. Braces to be securely fastened to post by suitable connections, and then trussed from line post back to terminal post with 3/8-inch round rod equipped with a turnbuckle for adjusting.

Fittings: Hot dip galvanized. All fittings to be malleable, cast iron or pressed steel.

Fabric-Bands: Fabric to be fastened to line post with (9 gauge) fabric bands spaced approximately 18 inches apart, and to top rail with wires (9 gauge) spaces approximately 24 inches apart.

Locks: Locks will be provided by the Owner.

INSTALLATION

General: Installation shall be made in a workmanlike manner by skilled workers experienced in the erection of this type of fence and in accordance with the manufacturer's recommendations. The fence shall be erected on a previously prepared surface to the lines and grades indicated on the plans.

Post Setting: All posts shall be set plumb and in alignment into a 36-inch concrete footing of proper size and shape so as to furnish sufficient support to withstand any strain or shock ordinarily brought to bear on a fence of this character. The concrete strength shall be 3000 psi (ASTM C-94) and the foundations a minimum of 9 inches in diameter for line post and 12 inches for terminal post.

Concrete shall be thoroughly compacted so as to be free of voids and finished in a dome. Straight runs shall not exceed 500 feet between brace posts. Concrete shall cure a minimum of 72 hours before any further work is done on the posts.

Fabric: The fabric and barbed wire shall be stretched to the proper tension as recommended by the manufacturer and securely fastened to the framework members to result in a straight fence line without sagging. The bottom of the fabric shall be held as uniformly as is practicable to the finished grade.

**DIVISION 2
SITE WORK
02931 - SOD**

GENERAL

Restoration of existing lawn areas outside of the public right-of-way disturbed by construction activities shall be by installation of new sod. Restoration and sod shall be performed as soon as practical, but the time period between initial disturbance, the utility installation and sod placement shall not exceed 60 days. Sod is defined as blocks, squares, strips of turf grass and adhering soil used for vegetative planting. Sodding and preparation of the sod bed shall be performed by an experienced landscape subcontractor specializing in this type of operation unless otherwise approved by the Public Works Commission in writing.

The Contractor shall adhere to the standards set forth by the American Association of Nurseryman and the Associated Landscape Contractors of America. All personnel shall be appropriately trained with regard to the degree of involvement so to assure the Owner the highest level of workmanship. Sod species suitable in this area are hybrid bermuda, centipede and zoysia; however the sod placed for each individual's lawn shall be the same species of sod as existing. Sodding may be performed at any time of the year except frozen sod shall not be placed nor shall sod be placed on frozen ground. The Contractor shall adapt his operations to variations in weather or soil conditions as necessary for the successful establishment and growth of a vigorous, disease free and weed free sod lawn.

MATERIAL

Materials, equipment and products incorporated in the work shall be approved by the Public Works Commission. The Contractor shall submit a list of the proposed materials with samples, if required. Package materials should be delivered in unopened original containers showing weight, analysis and name of manufacturer. The Contractor shall protect the material from deterioration and/or damage.

Sod shall contain 95 percent permanent grass; not more than five (5) percent weeds and undesirable grasses, good texture and free from obnoxious grasses, roots, stones and foreign materials. Sod shall be uniformly 1 ½ to 2 inches thick with a well developed fibrous root mat system in topsoil with clean cut edges. The sod shall be sufficiently dense and cut to the minimum required thickness such that if the sod is suspended by one corner, the sod will not tear apart. The sod shall be recently mowed to a height of not more than three (3) inches prior to harvest. The sod shall be supplied and maintained in a healthy condition as evidence by the grass being a normal green color in appearance, dense, and free from insects, pests, disease or injury. Sod shall be delivered to the job site within 24 hours after being cut and shall be installed within 24 hours after delivery. Any sod which is torn, broken or too dry will be rejected.

SOIL BED PREPARATION

Before landscape construction is to begin, the site shall be cleaned and disposed of brush, rubbish, stones, gravel and other foreign material within the area to be landscaped. Exposed ground surfaces disturbed during construction activities shall be graded to the original contours (allowing for the thickness of the sod) or as in the case of an altered contour such as a fill slope, graded as directed by the Public Works Commission to finish grade, or typical cross section. The sod bed shall be excavated to such a depth that after sod placement the top of the sod

shall be flush with surrounding grade or contours. Rake areas to be sodded smooth, free from unsightly variations, bumps, ridges or depressions. Do not start work until conditions are satisfactory and do not work during inclement or impending inclement weather.

The surface area to receive sod shall contain a minimum of four (4) inches of good, fertile, friable, organic natural topsoil loam as a base for laying the sod. Topsoil shall be free of clumps, brush, sticks, weeds, stones, roots, trash or other objectionable material. Contractor shall insure all topsoil to be free of plants or plant parts of quackgrass, johnson grass, nut sedge, poison ivy or other noxious weeds. The Contractor shall furnish and supplement the existing topsoil at no additional costs to the Public Works Commission providing a minimum four (4) inch thickness as specified. Soil preparation shall not be performed in frozen or extremely wet conditions. The finished topsoil bed shall be uniform in grade, with a yard like appearance. All changes in grade shall have a smooth, rounded peaks and valleys.

The soil shall be scarified or otherwise loosened to a depth of not less than five (5) inches and all clods shall be broken. The top four (4) inches shall be worked into an acceptable smooth, friable and uniformly fine texture sod bed by use of soil pulverizers, drags, harrows or by other methods approved by the Public Works Commission. Commercial grade fertilizer (8% nitrogen, 8% phosphate, 8% potash) shall be applied at a rate of 20 pounds per 100 square feet, super-phosphate at 12 pounds per 1,000 square feet and lime (dolomite limestone containing not less than 85% total carbamates) shall be applied at a rate of 25 pounds per 1,000 square feet or at a rate recommended for the type of sod being placed. Apply soil amendments within 24 hours after raking topsoil base surface and not more than 48 hours prior to laying sod. Mix thoroughly a minimum depth into the upper four (4) inches of topsoil and lightly water to aid in dissipation. Sod placement shall not begin until the soil preparation is inspected and approved by the Public Works Commission. During application of soil amendment fertilizer etc., adequate precautions shall be taken to prevent damage to existing features such as traffic, structures, landscape, trees, vegetation, utilities or any other appurtenances. The Contractor shall be required to repair or clean any damages.

PLACING SOD

The Contractor and his landscape subcontractor shall coordinate the placing of the sod to begin within 24 hours after the topsoil base preparation is completed and accepted by the Public Works Commission. Sod shall be brought to the site as near to the time of placing as possible. Store sod in the shade, and keep watered particularly in extreme hot and dry condition to insure vitality and to prevent the dropping off of soil during handling. During wet weather, the sod shall be allowed to dry sufficiently to prevent tearing. Handling shall be done in a manner which will prevent tearing, breaking, drying or other damage. Carefully place sod in rows with the longer side perpendicular to slopes and the ends staggered in each successive row in a brick-like pattern. Butt the ends and sides together tightly and do not overlap or stretch the sod. Do not leave any voids or gaps. Unavoidable gaps shall be closed with small pieces of torn or broken sod if kept moist and approved by the Public Works Commission. After the sod is laid, irrigate thoroughly to allow water to penetrate a minimum six (6) inches into the soil below the sod. Sod shall not be placed when the atmospheric temperature is below 32oF.

Tamp and roll completed sod installation with a manual roller or approved equipment to eliminate minor irregularities and to form close contact with the soil bed immediately after placing and watering. The type of rolling and tamping equipment to be used shall be submitted to the Public Works Commission for approval prior to construction. On steep slopes 3:1 (horizontal and vertical) or greater, in drainage ditches or any areas where sod slipping may

occur, anchor sod with approved wooden stakes ($\frac{1}{2}$ "x $\frac{3}{4}$ " x 12") or staples spaced not over two (2) feet apart in any direction and/or in sufficient number to prevent slippage or displacement. The anchors shall be driven flush with the surface of the sod. The wide flat side of the stake shall be driven parallel to the slope. Staking shall be done concurrently with sod placement and prior to tamping. Sod shall be laid with the long horizontal edge of the strips parallel to the contour starting at the bottom of the slope. The edge of the sod shall be turned slightly in the ground at the top of a slope and a layer of earth placed over it and compacted so as to conduct the surface water over and onto the top of the sod. Upon completion of the above described work, the surface of the sodded areas shall coincide with the finished grade and not exceed $\frac{1}{4}$ " plus or minus variation to adjoining grade or proposed contour. Extreme care shall be taken to prevent the installed sod from being torn or displaced.

MAINTENANCE

The Contractor shall, at no additional cost to the Public Works Commission, make whatever arrangements necessary to supply water of suitable quality and purity to sustain and encourage vigorous plant growth, and supply all equipment for proper delivery and application to planted areas. Water obtained from a PWC fire hydrant shall be metered and properly protected with an approved backflow prevention device. PWC must inspect and approved any connections to their water system to include the proposed water application and storage equipment. The Contractor shall not use private resident's water. The Contractor is solely responsible to provide watering of the sod. The method of application of water shall be approved by the Public Works Commission. Limit watering to early morning or late afternoon to enable to soil the absorb maximum amount of water.

Maintenance shall begin immediately after sodding operation. The Contractor shall maintain all sodded areas until sod is firmly established and as outlined below. Maintenance will include watering, fertilizer, pest control, soil amendments, disease control, erosion repair, mowing, protecting turf area from traffic (i.e. temporary fences, barriers, signs, etc.) and replacement of any dead or damaged sod.

Watering

- Water lawn areas once a day with a minimum $\frac{1}{2}$ inch water for the first three (3) weeks after area sodded.
- After the three (3) week period, water twice a week with a $\frac{3}{4}$ inch of water each time unless a comparable amount of rainfall has occurred.
- Make weekly inspections to determine moisture content of soil and supplement the above watering schedule as needed.
- Excessive runoff puddling and wilting shall be prevented.

Fertilizer and Pest Control

- Evenly spread fertilizer composite at a rate of 40 pounds per 5,000 square feet or as recommended by the manufacturer. Fertilizer shall not be applied until two (2) weeks after initial placement of the sod or prior to the advent of winter dormancy.
- Treat areas of weed and insect infestation as recommended by the treatment manufacturer.

Mowing

- The Contractor shall do mowing operations, (in yards not being mowed by residents) until provisional acceptance.
- Mowing shall be done only when the grass is dry with a rotary type mower having a blade height set not lower than one and one half (1½) inches nor higher than three (3) inches.
- Mowing operations shall be conducted at intervals, which ensure grass height does not exceed four (4) inches between mowing.
- The Contractor shall complete at least one mowing operation before the work will be considered for acceptance.

The Contractor shall protect and not allow access of vehicular traffic into any newly sodded areas and shall repair any damaged turf to original grade. Maintenance shall continue for a period of 90 days after placement or until provisional acceptance by the Public Works Commission. A written record shall be furnished to the Owner of the maintenance work performed. At least two weeks shall elapse after chemical control is applied before a request of inspection.

ACCEPTANCE

Fifteen (15) days prior to the end of the 90 day maintenance period, the Contractor shall make a written request to the Public Works Commission for an inspection and provisional acceptance of the sod. Failure to notify the Public Works Commission will not relieve the Contractor of the maintenance provisions required and the Contractor will continue to be responsible for the maintenance of the sod.

Replacement of dead sod shall be performed within seven (7) days after notification by the Public Works Commission and the maintenance period for these areas or individual lawns shall be extended for the 90 day maintenance period. Failure to replace dead sod within the specified seven (7) day period will result in the Public Works Commission having the work performed and deducting the cost from the Contract; however, the Contractor shall be responsible for the maintenance.

Final acceptance will be given upon satisfactory contract performance exhibited at final inspection and acceptance. Sodded areas are to be fully rooted prior to acceptance. The Owner shall be the sole judge as to whether or not the lawns are acceptable. Should any deficiencies be disclosed at final inspection, the Contractor shall make the necessary corrections in a timely manner and request re-inspection.

GUARANTEE

The Contractor shall guarantee a dense, vigorous stand of turf free of weeds, disease, pests or any dead areas more than one half of a square foot in size for a period of 90 days from initial placement or replacement whichever is greater. Total dead area shall not exceed one percent (1%) of total square footage for each individual resident's lawn.

**DIVISION 2
SITE WORK
02933 - LAWNS AND GRASSES (SEEDING)**

GENERAL

All exposed ground surfaces that have been disturbed during construction shall be graded to original contours as practicable, shaped to drain, and free of trash and debris. Grassing shall be accomplished as soon as practicable after sections of work are completed. Seeding and/or planting shall be performed by an experienced subcontractor specializing in this type of operation, unless otherwise approved by the Public Works Commission in writing. Disturbed sections shall not exceed one mile, without prior approval by the Public Works Commission. Grassing shall be in accordance with the Contract Documents.

PREPARATION OF THE SOIL

The surface area to receive seed shall contain a minimum of four (4) inches of good, fertile, friable, organic natural topsoil loam as a base for spreading the seed. Topsoil shall be free of clumps, brush, sticks, weeds, stones, roots, trash or other objectionable material. Contractor shall insure all topsoil to be free of plants or plant parts of quackgrass, johnson grass, nut sedge, poison ivy or other noxious weeds. The Contractor shall furnish and supplement the existing topsoil at no additional costs to the Public Works Commission providing a minimum 4-inch thickness as specified. Soil preparation shall not be performed in frozen or extremely wet conditions. The finished topsoil bed shall be uniform in grade, with a yard like appearance. All changes in grade shall have a smooth, rounded peaks and valleys.

The topsoil shall be loosened and mixed to the depth of four inches (4"). Suitable equipment (cultipackers, harrows, drags) meeting the approval of the Public Works Commission shall be used. This operation shall be accomplished by cutting on one (1) foot centers parallel to the contour of the slopes. On slopes that are steeper than 2:1, both depth preparation and degree of smoothness may be reduced, if approved by the Public Works Commission, but in all cases the slope surface shall be scarified groove, trenched or punctured so as to provide a textural plane of cut forming pockets, ridges, or trenches in which seeding material can lodge. Soil preparation shall not be performed when the soil is frozen, extremely wet or in an otherwise unfavorable working condition. The soil shall be free of any substance that might inhibit plant growth. Assistance of the local agricultural agent is recommended.

Lime shall be applied at the rate of 1/2 tons per acre. 10-20-20 commercial fertilizer shall be applied at the rate of 1,000 pounds per acre and well worked in to the top four inches (4") of top soil. If hydroseeding, use 500 pounds of 10-10-10 fertilizer on slopes steeper than 1/2 horizontal to 1 vertical.

SEED MIXTURE AND SOWING THE SEED

Seed shall be seed certified to be the latest season's crop and shall be delivered in original sealed packages bearing the producer's guaranteed analysis for percentages of mixtures and pure live seed. The producer's seed label shall indicate it the minimum percent of pure live seed (which shall be 82.45 for Bermuda, 88 for Rye Grain), the minimum percent of germination in hard seed and maximum percent of weed seed (no more than 1 percent for Bermuda, 0.5 percent for Rye Grain). Seed shall be labeled in conformance with U.S. Department of Agriculture rules and regulations under the Federal Seed Act and applicable State seed laws.

Seed that has become wet, moldy, or otherwise damaged will not be acceptable.

The following seed mixture shall be used:

	<u>POUNDS OF SEED PER ACRE</u>			
Bermuda	K-31 Fescue	Rye	Grain Centipede	Common
April 15 - Sept. 1	75	-	60 (hulled)	5
Aug. 15 - Nov. 15	120	-	25 (hulled)	5
Nov. 1 - April 1	120	120	25 (un-hulled)	5

Note: If there are differences in the seed mixture between the mixture stated in these specifications and that which is specified as part of an approved Erosion Control Plan, the seed mixture specified in the erosion control plan shall take precedence.

Where construction crosses a pasture that has been grassed, the Contractor shall re-seed the area with the same type of grass as found on the site. All highway rights-of-way, and private yards disturbed shall also be re-seeded or with the same type of grass previously found. The seed mixture specification shall be used as a guide and the Contractor is charged with the responsibility of seeding areas with the proper type of grass that matches the existing.

Seed shall be broadcast uniformly by hand or by approved sowing equipment. One half of the seed shall be sown in one direction and the remaining shall be sown at right angles to the first. Do not seed when the wind velocity exceeds five (5) miles per hour. Rake lightly into top 1/8 inch of the soil prior to compacting, with a roller not exceeding 100 pounds.

All seeded areas will be mulched with two (2) tons per acre of small grain straw or wood cellulose fiber spread uniformly, approximately 1/4 of ground should be visible to avoid smothering seedlings. Asphalt emulsion (ASTM D-977 and ASTM D-2028) shall be used to anchor the straw applied at 150 gallons per ton of straw, or crimped to stabilize. Asphalt emulsion shall be required from November 1st to March 31st. The Contractor shall take sufficient precautions to prevent mulch from entering drainage structures through displacement by wind, water or other causes and promptly remove any blockage which may occur.

SPECIAL CONSIDERATIONS

Shrubbery shall be expertly removed and carefully preserved for replanting, unless otherwise directed by the Public Works Commission adequate earth ball shall be removed to guard against damage to the root system. Shrubbery shall be replanted only after all construction is complete. The excavation made for replanting shall be six inches (6") larger in every dimension than the root ball removed. This additional space shall be filled with a mixture of one half topsoil and one half peat moss. Care shall be taken to set the top of the ball slightly above or flush with the surrounding surface. Any shrubbery damaged or that dies shall be replaced with an equal or better plant material at the Contractor's expense.

MAINTENANCE

The Contractor shall protect and maintain grassed areas as necessary to establish a uniform turf composed of the grasses specified. The Contractor shall re-seed any bare areas and repair all eroded areas.

Watering of seeded areas will be required during periods of dry weather to promote maximum growth. The Contractor shall supplement natural rainfall to insure a minimum of one (1) inch of rainfall weekly.

Maintenance of lawns begins immediately after the area is planted and continues for the period required to establish acceptable lawns, but not less than sixty (60) days after initial seeding, or until provisional acceptance by Owner. Maintain seeded areas by watering, fertilizing, mowing, weeding and other operations such as rolling, re-grading, replanting, aerating, and mulching as required to establish an acceptable lawn free of eroded or bare areas.

ACCEPTANCE

Fifteen (15) days prior to the end of the sixty (60) day maintenance period, the Contractor shall make a written request to the Owner for an inspection and provisional acceptance of the seeded area. Failure to notify the Owner will not relieve the Contractor of the maintenance provisions required and the Contractor will continue to be responsible for the maintenance of the seeded area.

Replacement of dead seed area(s) shall be performed within seven (7) days after notification by the Public Works Commission and the maintenance period for these areas or individual lawns shall be extended for an additional sixty (60) day maintenance period. Failure to replace seeded area(s) within the specified seven (7) day period will result in the Owner having the work performed and deducting the cost from the Contract; however, the Contractor shall be responsible for the maintenance.

Final acceptance will be given upon satisfactory contract performance exhibited at final inspection and acceptance. Seeded areas are to be fully rooted prior to acceptance. The Owner shall be the sole judge as to whether or not the lawns are acceptable. Should any deficiencies be disclosed at final inspection, the Contractor shall make the necessary corrections in a timely manner and request re-inspection.

Payment to the Contractor for seeding areas will be approved once the seed has been established and meets the requirements of this paragraph of this specification.

GUARANTEE

The Contractor shall guarantee a stand of turf is considered acceptable when a live vigorous stand of permanent grass is established with growing sprouts visible at the surface showing not less than 9 seedlings of permanent grass at least 2 inches long in each square foot, and where no gaps larger than 4 inches in diameter occur anywhere in the lawn area. Permanent grass is defined as Common Bermuda, Centipede, and Fescue.

**DIVISION 2
SITE WORK
02934 - SEEDING WETLANDS**

GENERAL

All exposed ground surfaces that have been disturbed during construction shall be graded to original contours, reasonably smooth, and free of trash and debris. Grassing shall be accomplished as soon as practicable after sections of work are completed. Seeding shall be performed by an experienced subcontractor specializing in this type of operation, unless otherwise approved by the Engineer in writing. Disturbed sections shall not exceed one half mile, without prior approval by the Engineer. Grassing shall be in accordance with the following specifications:

PREPARATION OF THE SOIL

The topsoil shall be loosened and mixed to the depth of 4" to 8". Suitable equipment meeting the approval of the Engineer shall be used. The soil shall be free of clay lumps, brush, weeds, stones, roots, stumps or any other substance that might inhibit plant growth. Assistance of the local agricultural agent is recommended.

Provide agricultural lime at rate required to bring soil acidity to slightly acid - ph 6, according to soil test report.

Lime and fertilizer shall be applied uniformly and mixed with the soil during seedbed preparation. Apply 10-20-10 commercial fertilizers at the rate of 20-lbs./1000 s.f. for warm season mix and 10-20-10 commercial fertilizer at a rate of 20 lbs./1000 s.f. for cool season mix.

Apply 10-10-10 commercial fertilizers at the rate of 20-lbs./1000 s.f. for temporary cover crops. In addition, provide 15-lbs./1000 s.f. of superphosphate.

The following is for the warm season mix:

- a. All warm grass seed shall be debarbed or conditioned by brushing to create a product nearly the same as debarbing. This does not apply to Switchgrass.
- b. Disk two times to break-up crop residue and dirt clods prior to seeding.
- c. Pack soil to create a firm seedbed with a cultipacker or roller.
- d. If a rain shower should fall after the seedbed is prepared but before planting break-up any crust formation.
- e. Seeding shall be installed to a depth of 1/4" utilizing a rangeland drill or conventional grass drills. It is extremely important that seed not be planted deeper than 1/2" depth. Do not disc or harrow after seeding. This will put the seed too deep. A Brillion seeder will be acceptable.

The following seed mixture shall be used:

Dates	Types	Rate
April 1 - July 15	<i>Warm Season Mix</i> Switchgrass, Cave-in-rock, Alamo Smartweed; and Japanese Millet or Sorghum Sudan Grass Hybrids (Mow prior to maturity)	8 pls #/acre or 4 oz./1000 s.f. 2 bulk #/acre or 1 oz./1000 s.f. 20-lb/acre or ½ lbs/1000 s.f.
July 16 - Sept 1	Temporary crop of Japanese Millet or Sorghum Sudan Grass Hybrids (To be followed by permanent mixture)	20-lb/acre or ½ lbs/1000 s.f.
Sept 2 - Nov 1	<i>Cool Season Mix</i> Reed Canary Grass	12 bulk #/acre or 6 oz./1000 s.f.
	Smartweed	2 bulk #/acre or 1 oz./1000 s.f.
Nov 2 - March 31	Temporary Crop of Wheat (To be followed by permanent mixture)	40 lbs/acre

All highway rights-of-way, and private yards disturbed shall also be re-seeded or sodded with the same type of grass previously found. The seed mixture specification shall be used as a guide and the Contractor is charged with the responsibility of seeding areas with the proper type of grass existing.

Seed shall be broadcast uniformly by hand or by approved sowing equipment. One half of the seed shall be sown in one direction and the remaining shall be sown at right angles to the first. Do not seed when the wind velocity exceeds 5 miles per hour. Rake lightly into top 1/8 inch of the soil prior to compacting, with a roller not exceeding 100 pounds.

All seeded areas will be mulched with 75 pounds to 100-lbs./1000 s.f. of clean wheat straw, spread uniformly, approximately 1/4 of ground should be visible to avoid smothering seedlings. If hydro-seeded, use virgin paper mulch only. The Contractor shall take sufficient precautions to prevent mulch from entering drainage structures through displacement by wind; water or other causes and promptly remove any blockage, which may occur.

MAINTENANCE AND GUARANTEE

The Contractor shall protect and maintain grassed areas as necessary to establish a uniform turf composed of the grasses specified. The Contractor shall re-seed any bare areas and repair all eroded areas.

Maintain seeded areas by watering, fertilizing, mowing, weeding, and other operations such as rolling, regrading, replanting, aerating, mulching as required to establish an acceptable lawn free of eroded or bare areas.

ACCEPTANCE

The Contractor shall guarantee a stand of turf is considered acceptable when a live vigorous stand of permanent grass is established with growing sprouts visible at the surface showing not less than 9 seedlings of permanent grass at least 2 inches long in each square foot, and where no gaps larger than 4 inches in diameter occur anywhere in the seeded area.

SECTION E – DETAILS

1. UNLESS OTHERWISE INDICATED, ALL VEGETATIVE AND STRUCTURAL EROSION AND SEDIMENT CONTROL MEASURES SHALL BE CONSTRUCTED AND MAINTAINED IN ACCORDANCE WITH THE MINIMUM STANDARDS AND SPECIFICATIONS OF THE NORTH CAROLINA EROSION AND SEDIMENT CONTROL HANDBOOK. (NO SEPARATE PAYMENT).

2. THE CONTRACTOR SHALL NOTIFY PLAN APPROVING AUTHORITY ONE WEEK PRIOR TO THE PRECONSTRUCTION CONFERENCE, ONE WEEK PRIOR TO THE COMMENCEMENT OF LAND DISTURBING ACTIVITY, AND ONE WEEK PRIOR TO FINAL INSPECTION.

3. ALL EROSION AND SEDIMENT CONTROL MEASURES ARE TO BE PLACED PRIOR TO CLEARING AND/OR LAND DISTURBANCE.

4. A COPY OF THE APPROVED EROSION AND SEDIMENT CONTROL PLAN AND PERMIT SHALL BE MAINTAINED ON THE SITE AT ALL TIMES.

5. PRIOR TO COMMENCING LAND DISTURBING ACTIVITIES IN AREAS OTHER THAN INDICATED ON THESE PLANS (INCLUDING, BUT NOT LIMITED TO OFF-SITE BORROW OR WASTE AREAS, STAGING OR STORAGE AREAS), THE CONTRACTOR SHALL PREPARE AND SUBMIT A SUPPLEMENTARY EROSION CONTROL PLAN TO THE OWNER FOR REVIEW AND TO NCDENR REGIONAL OFFICE FOR APPROVAL. CONTRACTOR SHALL PAY ALL FEES REQUIRED AND SHALL INSTALL NECESSARY MEASURES AT NO SEPARATE PAYMENT. THE CONTRACTOR SHALL PROVIDE THE OWNER AND THE ENGINEER A COPY OF THE AMENDED PERMIT.

6. THE CONTRACTOR IS RESPONSIBLE FOR INSTALLATION OF ANY ADDITIONAL EROSION CONTROL MEASURES NECESSARY TO PREVENT EROSION AND SEDIMENTATION AS DETERMINED BY EITHER NCDENR OR THE ENGINEER. (NO SEPARATE PAYMENT).

7. ALL DISTURBED AREAS ARE TO DRAIN TO APPROVED SEDIMENT CONTROL MEASURES AT ALL TIMES DURING LAND DISTURBING ACTIVITIES AND DURING SITE DEVELOPMENT UNTIL FINAL STABILIZATION IS ACHIEVED.

8. ALL AREAS DISTURBED BY CONSTRUCTION UNLESS OTHERWISE IMPROVED SHALL BE SODDED OR SEEDED AS INDICATED AND STABILIZED.

9. DURING DEWATERING OPERATIONS, WATER SHALL BE PUMPED INTO AN APPROVED FILTERING DEVICE PRIOR TO DISCHARGE TO RECEIVING OUTLET.

10. THE CONTRACTOR SHALL INSPECT ALL EROSION CONTROL MEASURES WEEKLY AND AFTER EACH RUNOFF-PRODUCING EVENT. ANY NECESSARY REPAIRS OR CLEANUP TO MAINTAIN THE EFFECTIVENESS OF THE EROSION CONTROL DEVICES SHALL BE MADE IMMEDIATELY.

11. ALL TEMPORARY EROSION CONTROL MEASURES SHALL BE REMOVED BY CONTRACTOR ONCE STABILIZATION OR A SUFFICIENT GROUND COVER HAS BEEN ESTABLISHED OR AS DIRECTED BY THE ENGINEER. (NO SEPARATE PAYMENT). NCDENR'S FINAL APPROVAL IS REQUIRED.

12. TEMPORARY GRAVEL CONSTRUCTION ENTRANCE SHALL BE REQUIRED AT ALL CONSTRUCTION STAGING AREA ENTRANCES AND ALL CONSTRUCTION ACCESS LOCATIONS INTO NON-PAVED AREA. (NO SEPARATE PAYMENT).

13. WHEN CROSSING CREEK OR DRAINAGE-WAY, THE CONTRACTOR SHALL RIP-RAP WITH FABRIC DISTURBED BANKS AND CHANNEL AND RESTORE SLOPES TO ORIGINAL CONTOURS, BUT NOT STEEPER THAN 2:1 MAXIMUM. DISTURBED CREEK AREA SHALL BE STABILIZED IMMEDIATELY.

14. SEDIMENT FENCES SHALL BE REMOVED FROM THE SITE WHEN GRASSING IS ACCEPTED AND STABILIZATION IS COMPLETE.

15. WHEN A LINE IS TO BE INSTALLED ALONG A SHOULDER WITH A SLOPE FROM THE ROAD, SOIL (FILL) REMOVED FROM THE CUT SHALL BE STOCKPILED ON THE PAVEMENT SIDE OF THE CUT. THE CONTRACTOR SHALL REMOVE ALL WASTE MATERIAL FROM THE SITE PER THE JOB SPECIFICATIONS. CONTRACTOR SHALL SWEEP ALL MATERIAL OFF ROAD WHERE SOIL IS STOCKPILED EACH DAY PRIOR TO OPENING LANE AS PER N.C.D.O.T.

GENERAL EROSION AND SEDIMENT CONTROL NOTES			PUBLIC WORKS COMMISSION FAYETTEVILLE, N.C.			NO.	DATE	REVISION
SHEET NO. 1 OF 1	DWG. NO. EC.1	DWG. BY PWC	WATER RESOURCES ENGINEERING DEPARTMENT					
	DATE: JULY 01, 2011	APPROVED BY J.E.G.						

GRAVEL ENTRANCE SHALL BE 50 FEET
IN LENGTH AND 20 FEET IN WIDTH
WITH 20 FOOT RADIUS AT EXISTING
ROADWAY

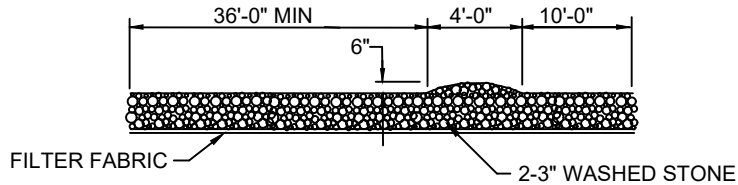

GRAVEL CONSTRUCTION ENTRANCE

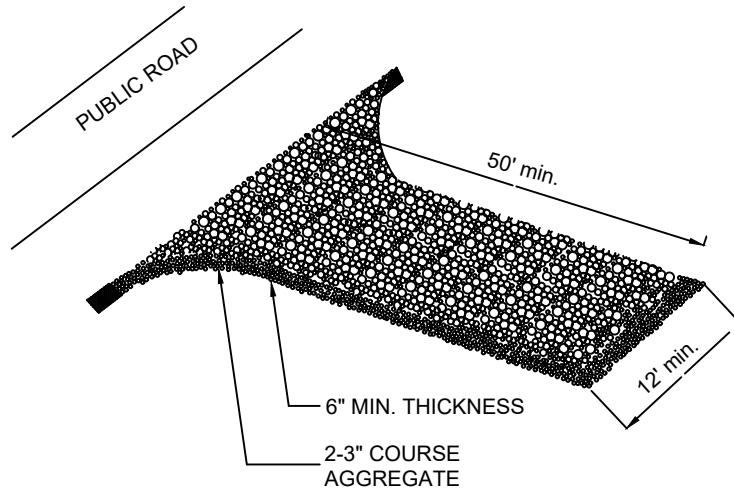

DESIGN CRITERIA

AGGREGATE SIZE - USE 2-3 INCH WASHED STONE

DIMENSION OF GRAVEL PAD

THICKNESS - 6 INCHES MINIMUM

WIDTH - 12 FT. MINIMUM OR FULL WIDTH AT ACCESS
POINTS OF THE VEHICULAR ENTRANCE AND EXIT
AREA, WHICHEVER IS GREATER

LENGTH - 50 FT. MINIMUM.

LOCATION - LOCATE CONSTRUCTION ENTRANCES AND
EXITS TO LIMIT SEDIMENT FROM LEAVING THE SITE
AND TO PROVIDE FOR MAXIMUM UTILITY BY ALL
CONSTRUCTION VEHICLES. AVOID STEEP GRADES
AND ENTRANCES AT CURVES IN PUBLIC ROADS.

CONTRACTOR SHALL INSTALL ADDITIONAL GRAVEL
CONSTRUCTION ENTRANCES NOT INDICATED ON THE PLANS
REQUIRED FOR STAGING AND/OR BORROW AREAS AND
MAINTAIN AT NO ADDITIONAL EXPENSE TO THE OWNER.

CONTRACTOR SHALL SUPPLEMENT AND MAINTAIN GRAVEL
CONSTRUCTION ENTRANCES AT HIS EXPENSE UNTIL FINAL
ACCEPTANCE.

TEMPORARY GRAVEL
CONSTRUCTION ENTRANCE

PUBLIC WORKS COMMISSION
FAYETTEVILLE, N.C.



NO.	DATE	REVISION

SHEET NO. 1 OF 1	DWG. NO. EC.2	DWG. BY FAYPWC
	DATE: NOV. 2011	APPROVED BY J.E.G.

WATER RESOURCES
ENGINEERING DEPARTMENT

DRIVE STEEL POSTS 24" INTO THE GROUND 8' O.C. (MAX.) AND EXCAVATE A 4"x8" TRENCH UPHILL ALONG THE LINE OF POSTS.

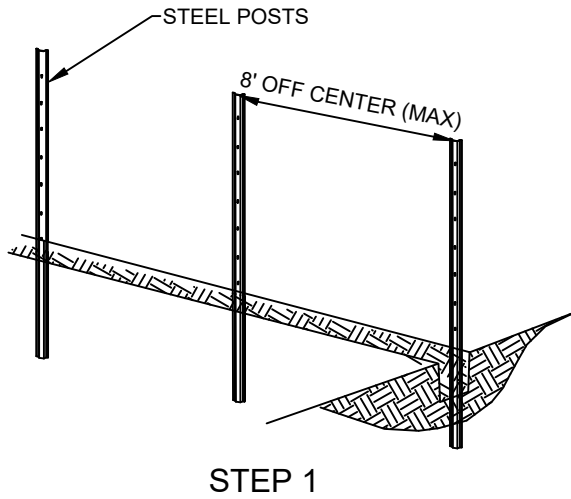

ATTACH WIRE FENCE TO POSTS. WIRE FENCE SHALL EXTEND TO BOTTOM OF TRENCH. FASTEN WIRE FENCE TO POSTS WITH WIRE OR PLASTIC ZIP TIES.

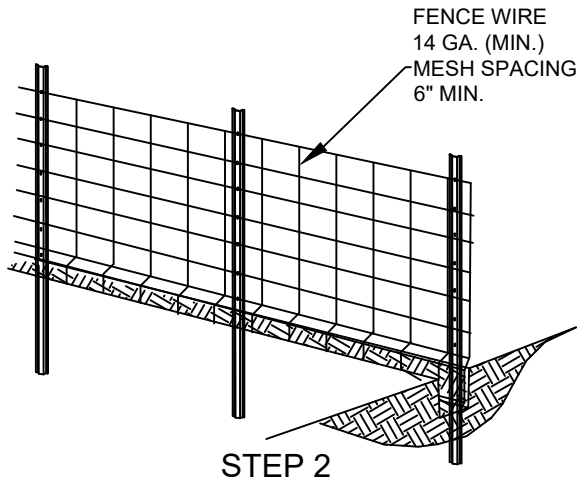

ATTACH THE FILTER FABRIC TO THE WIRE FENCE AND EXTEND THE BOTTOM OF THE FABRIC DOWN THE SIDE OF TRENCH AND ACROSS BOTTOM OF TRENCH.

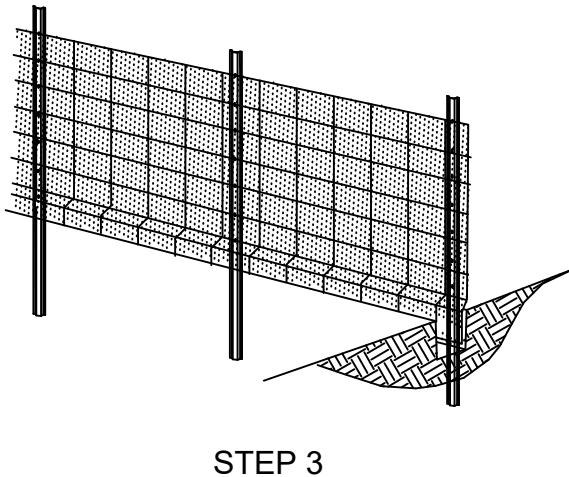

BACKFILL THE TRENCH AND COMPACT THE SOIL FIRMLY TO ANCHOR THE BOTTOM OF THE SILT FENCE. BURIED FABRIC SHALL NOT BE VISIBLE.

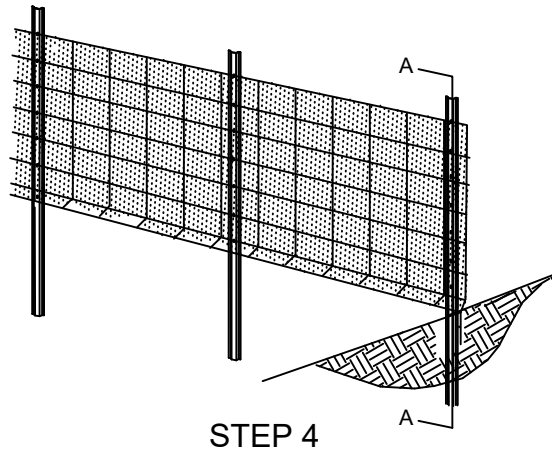

NOTES:

1. WIRE SHALL BE A MINIMUM OF 32 INCHES IN WIDTH AND SHALL HAVE A MAXIMUM OF 6" MESH SPACING.
2. FILTER FABRIC SHALL BE A MINIMUM OF 36" IN WIDTH AND SHALL BE FASTENED ADEQUATELY TO THE WIRE WITH WIRE OR PLASTIC ZIP TIES WITH MIN. 50LBS TENSILE STRENGTH. FABRIC THAT DETERIORATES TO SUCH EXTENT THAT IT'S EFFECTIVENESS IS REDUCED SHALL BE REPLACED BY CONTRACTOR AT CONTRACTOR'S EXPENSE.
3. STEEL POSTS SHALL BE A MIN. OF 5' HEIGHT AND SHALL BE THE SELF FASTENER ANGLE STEEL TYPE.
5. CONTRACTOR SHALL REVIEW SILT FENCE PERIODICALLY AND AFTER EACH RAINFALL OCCURRENCE. ANY NECESSARY REPAIRS OR CLEAN-UP TO MAINTAIN THE EFFECTIVENESS OF THE DEVICE SHALL BE MADE IMMEDIATELY.
6. TEMPORARY MEASURE SHALL BE REMOVED BY THE CONTRACTOR ONCE STABILIZATION OR SUFFICIENT GROUND COVER IS ACHIEVED AS DIRECTED BY THE ENGINEER.

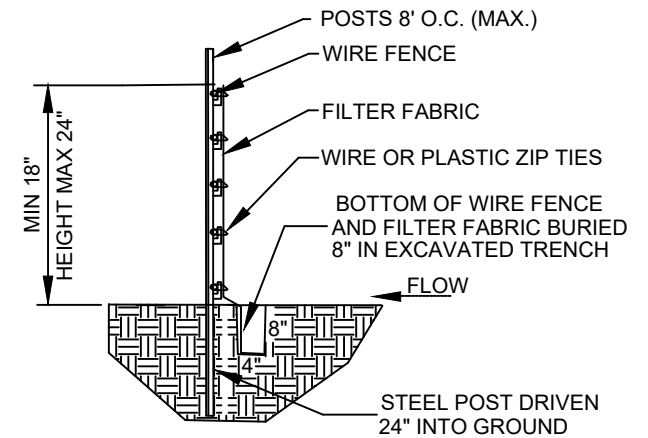

SECTION A-A

SILT FENCE
N.T.S.

PUBLIC WORKS COMMISSION
FAYETTEVILLE, N.C.



NO.	DATE	REVISION

SHEET NO. 1 OF 1	DWG. NO. EC.3	DWG. BY: FAYPWC
	DATE: JULY 01, 2014	APPROVED BY: J.E.G.

WATER RESOURCES
ENGINEERING DEPARTMENT

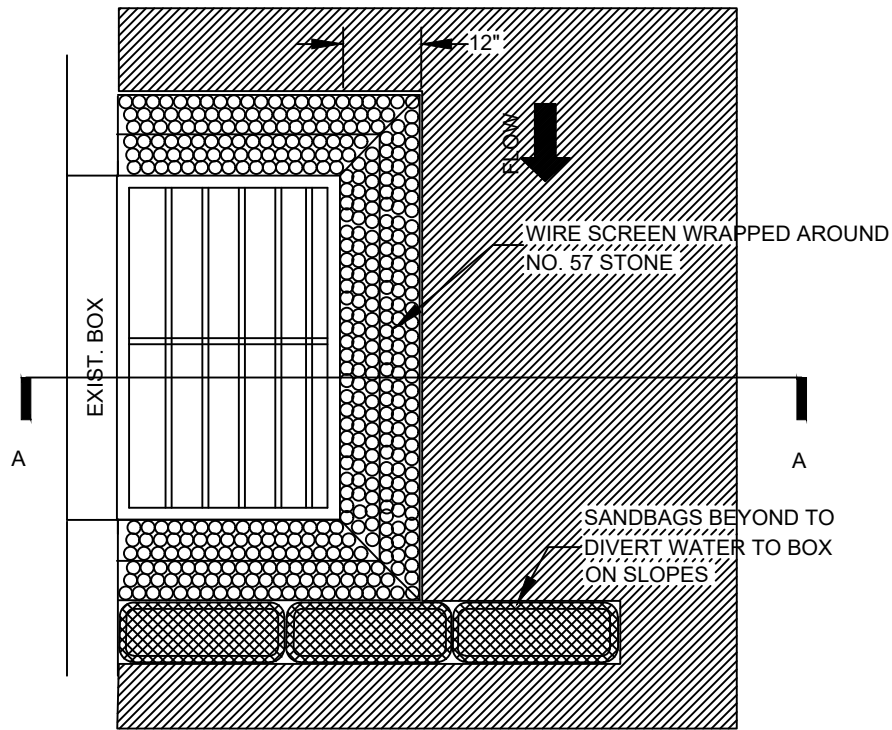

PLAN

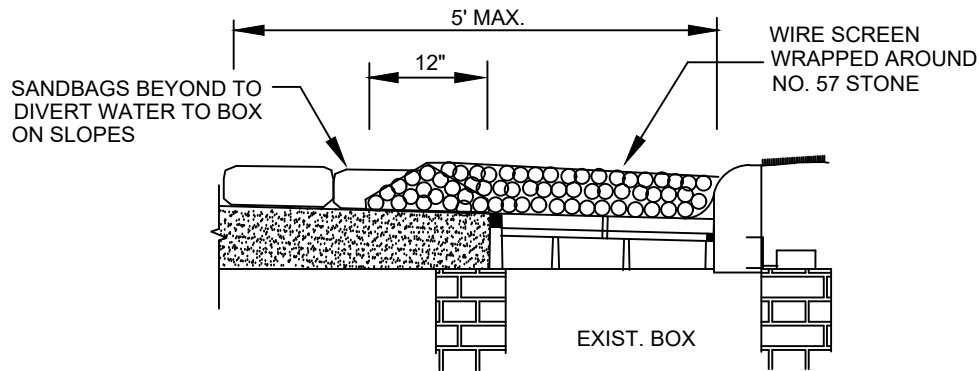

SECTION "A-A"

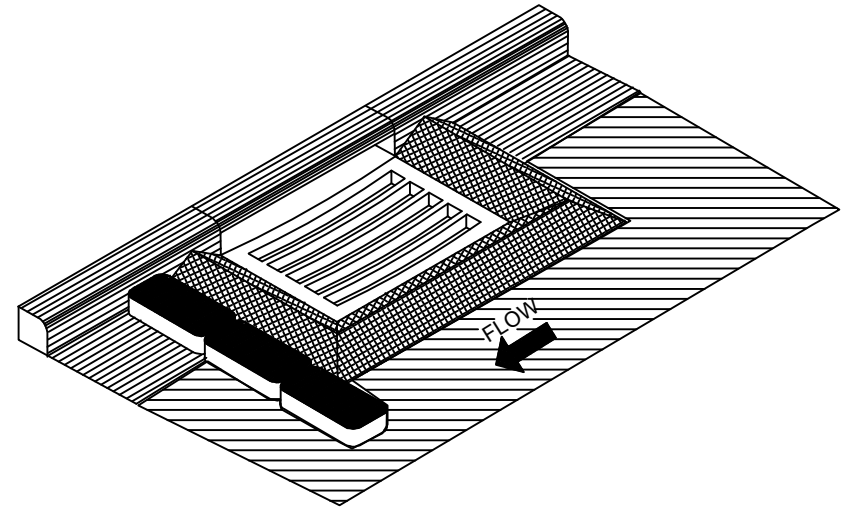

NOTES:

1. INLET PROTECTION SHALL BE INSTALLED IN LOCATIONS AS INDICATED ON THE PLAN.
2. CONTRACTOR SHALL PERIODICALLY AND AFTER EACH RAINFALL EVENT REMOVE SEDIMENT AND OTHER DEBRIS FROM AROUND BASIN.
3. SANDBAGS SHALL BE INSTALLED ADJACENT TO INLETS ON SLOPES. SANDBAGS SHALL NOT BE INSTALLED ADJACENT TO BASINS IN LOW AREAS.

CATCH BASIN INLET PROTECTION
N.T.S.

PUBLIC WORKS COMMISSION
FAYETTEVILLE, N.C.

NO.	DATE	REVISION

SHEET NO.
1 OF 1

DWG. NO. EC.6
DATE: JULY 01, 2014

DWG. BY FAYPWC
APPROVED BY J.E.G.

WATER RESOURCES
ENGINEERING DEPARTMENT



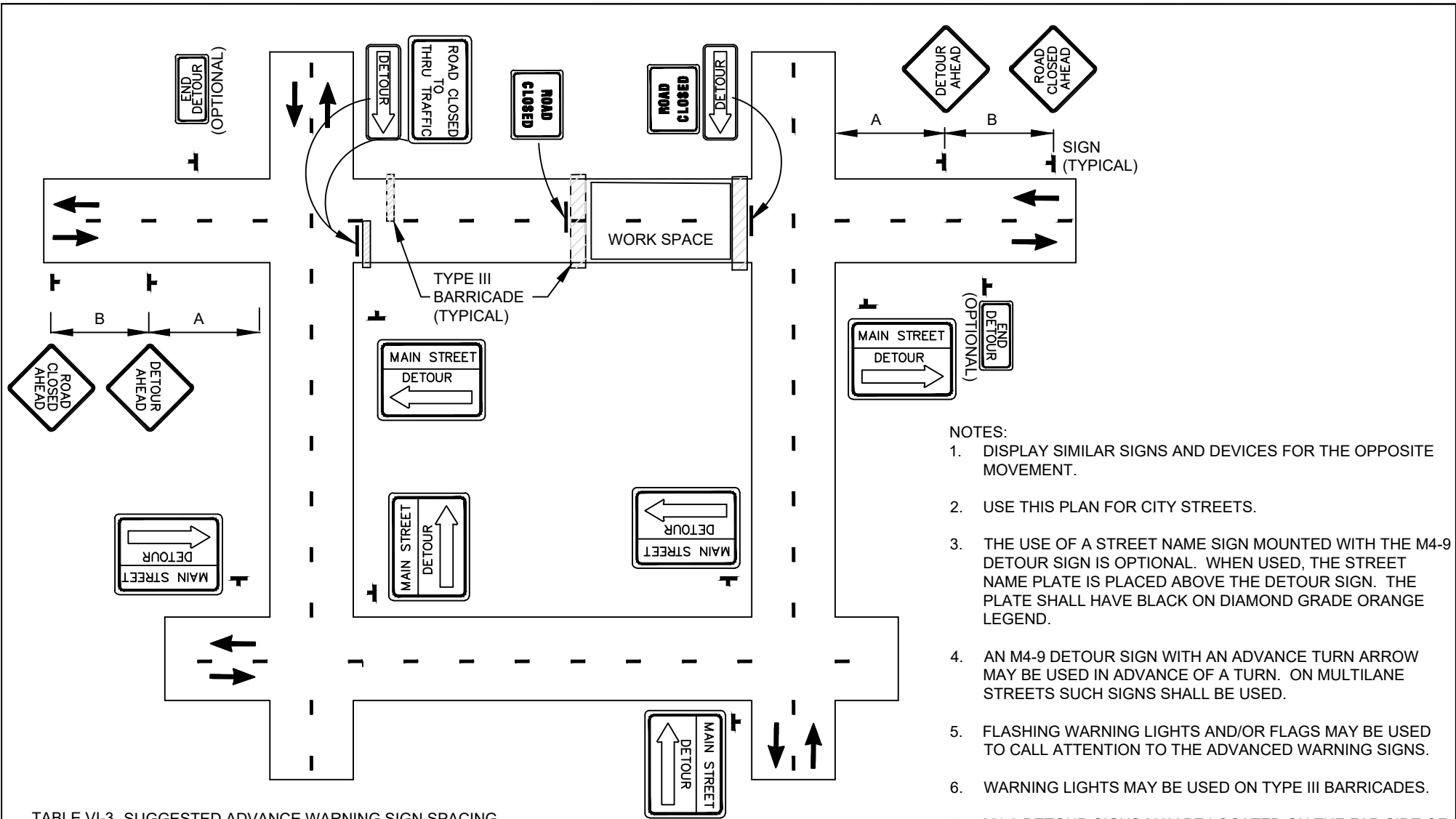

- NOTES:
1. DISPLAY SIMILAR SIGNS AND DEVICES FOR THE OPPOSITE MOVEMENT.
 2. USE THIS PLAN FOR CITY STREETS.
 3. THE USE OF A STREET NAME SIGN MOUNTED WITH THE M4-9 DETOUR SIGN IS OPTIONAL. WHEN USED, THE STREET NAME PLATE IS PLACED ABOVE THE DETOUR SIGN. THE PLATE SHALL HAVE BLACK ON DIAMOND GRADE ORANGE LEGEND.
 4. AN M4-9 DETOUR SIGN WITH AN ADVANCE TURN ARROW MAY BE USED IN ADVANCE OF A TURN. ON MULTILANE STREETS SUCH SIGNS SHALL BE USED.
 5. FLASHING WARNING LIGHTS AND/OR FLAGS MAY BE USED TO CALL ATTENTION TO THE ADVANCED WARNING SIGNS.
 6. WARNING LIGHTS MAY BE USED ON TYPE III BARRICADES.
 7. M4-9 DETOUR SIGNS MAY BE LOCATED ON THE FAR SIDE OF THE INTERSECTIONS.
 8. THIS STANDARD DERIVED FROM PART VI OF THE M.U.T.C.D., (STANDARDS AND GUIDES FOR STREET AND HIGHWAY CONSTRUCTION, MAINTENANCE, UTILITY, AND INCIDENT MANAGEMENT OPERATIONS) ISSUED APRIL 1995.

TABLE VI-3 SUGGESTED ADVANCE WARNING SIGN SPACING

ROAD TYPE	DISTANCE BETWEEN SIGNS		
	A	B	C
URBAN LOW-SPEED	200	200	200
URBAN HIGH SPEED	350	350	350
RURAL	500	500	500
EXPRESSWAY/FREEWAY	1,000	1,600	2,600

FIGURE TA-20 DETOUR FOR CLOSED STREET N.T.S.			FAYETTEVILLE PUBLIC WORKS COMMISSION FAYETTEVILLE, N.C.			NO.	DATE	REVISION
SHEET NO. 1 OF 1	DWG. NO. M.7	DWG. BY: FAYPWC	WATER RESOURCES ENGINEERING DEPARTMENT					
	DATE: JULY 01, 2023	APPROVED BY: M.M.M.						

TABLE VI-3 SUGGESTED ADVANCE WARNING SIGN SPACING

ROAD TYPE	DISTANCE BETWEEN SIGNS		
	A	B	C
URBAN LOW-SPEED	200	200	200
URBAN HIGH SPEED	350	350	350
RURAL	500	500	500
EXPRESSWAY/FREEWAY	1,000	1,600	2,600

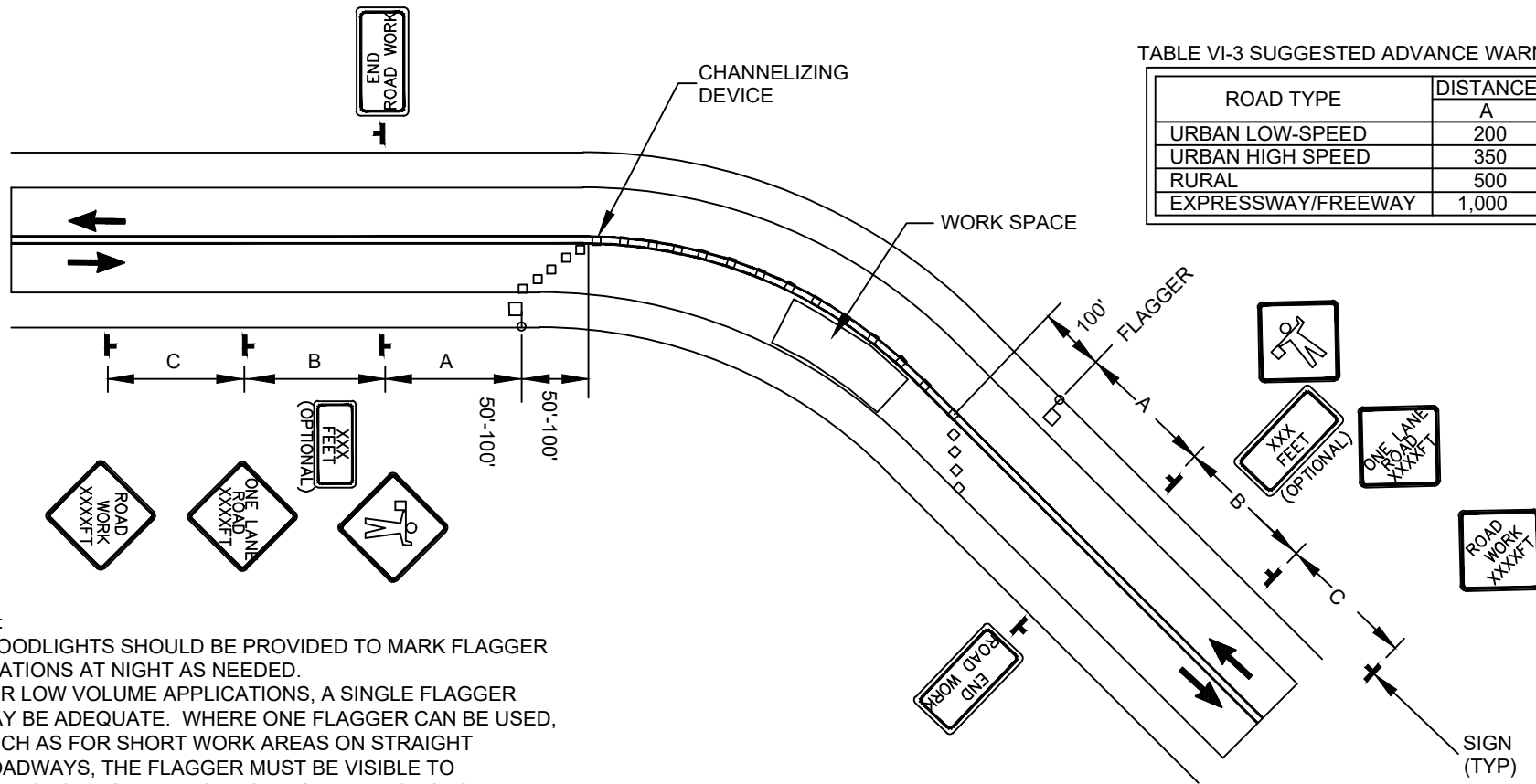

NOTES:

1. FLOODLIGHTS SHOULD BE PROVIDED TO MARK FLAGGER STATIONS AT NIGHT AS NEEDED.
2. FOR LOW VOLUME APPLICATIONS, A SINGLE FLAGGER MAY BE ADEQUATE. WHERE ONE FLAGGER CAN BE USED, SUCH AS FOR SHORT WORK AREAS ON STRAIGHT ROADWAYS, THE FLAGGER MUST BE VISIBLE TO APPROACHING TRAFFIC FROM BOTH DIRECTIONS.
3. CHANNELIZING DEVICES ARE TO BE EXTENDED TO A POINT WHERE THEY ARE VISIBLE TO APPROACHING TRAFFIC.
4. THE ROAD WORK AHEAD AND THE END ROAD WORK SIGNS MY BE OMITTED FOR SHORT DURATION OPERATIONS.
5. FLASHING WARNING LIGHTS AND/OR FLAGS MAY BE USED TO CALL ATTENTION TO THE ADVANCED WARNING SIGNS.
6. THIS STANDARD DERIVED FROM PART VI OF THE M.U.T.C.D., (STANDARDS AND GUIDES FOR STREET AND HIGHWAY CONSTRUCTION MAINTENANCE, UTILITY, AND INCIDENT MANAGEMENT OPERATIONS) ISSUED APRIL 1995.

FIGURE TA-10
LANE CLOSURE ONE LANE
TWO-WAY TRAFFIC
N.T.S.

FAYETTEVILLE
PUBLIC WORKS COMMISSION
FAYETTEVILLE, N.C.



WATER RESOURCES
ENGINEERING DEPARTMENT

NO.	DATE	REVISION

SHEET NO. 1 OF 1	DWG. NO. M.8	DWG. BY: FAYPWC
	DATE: JULY 01, 2023	APPROVED BY: M.M.M.

APPENDICES

APPENDIX A

SEWER MANHOLE REHAB MAPS

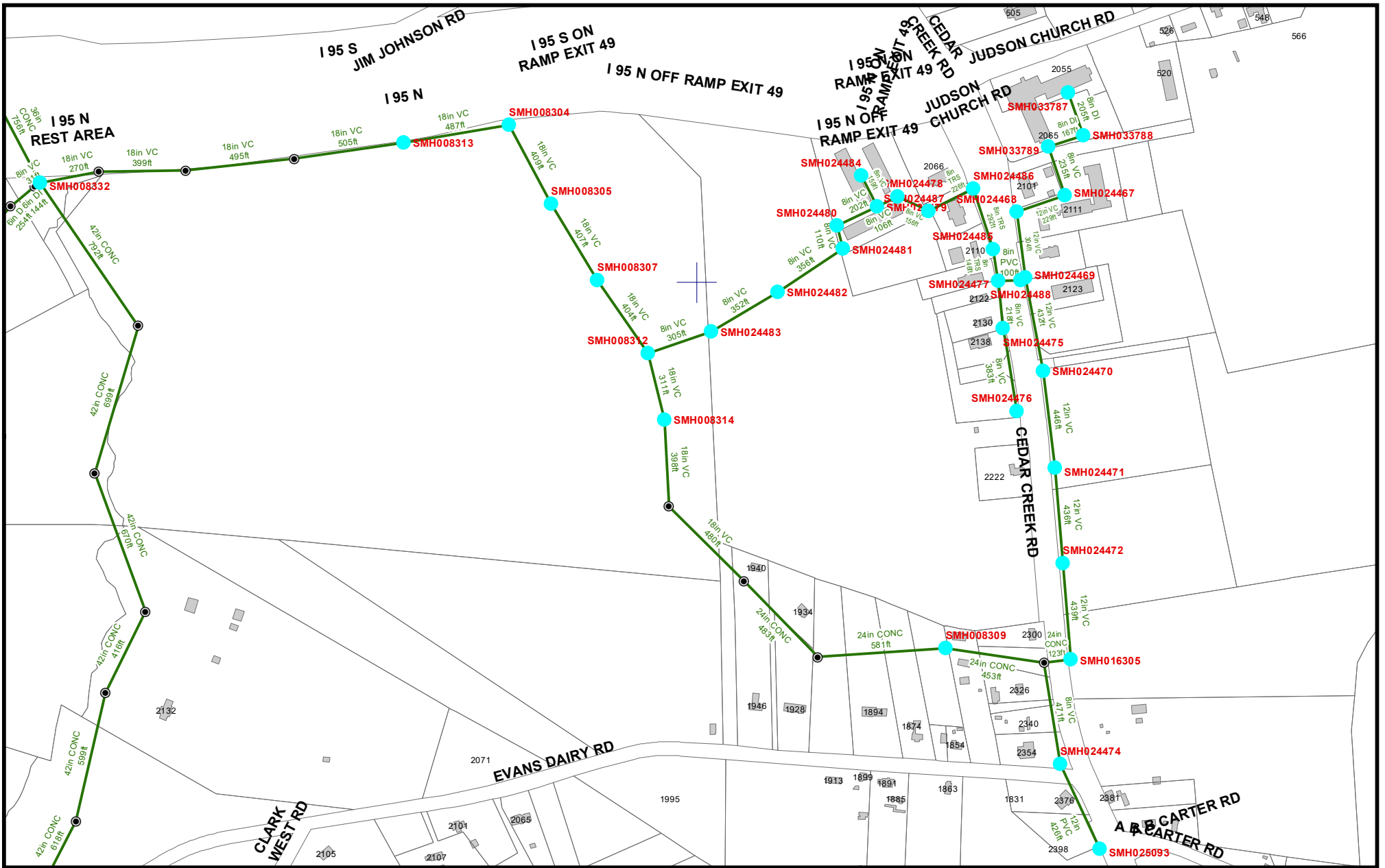

 10/6/2021
 1 inch = 600 feet

Sewer Manhole Rehabilitation 2022 Cedar Creek Road

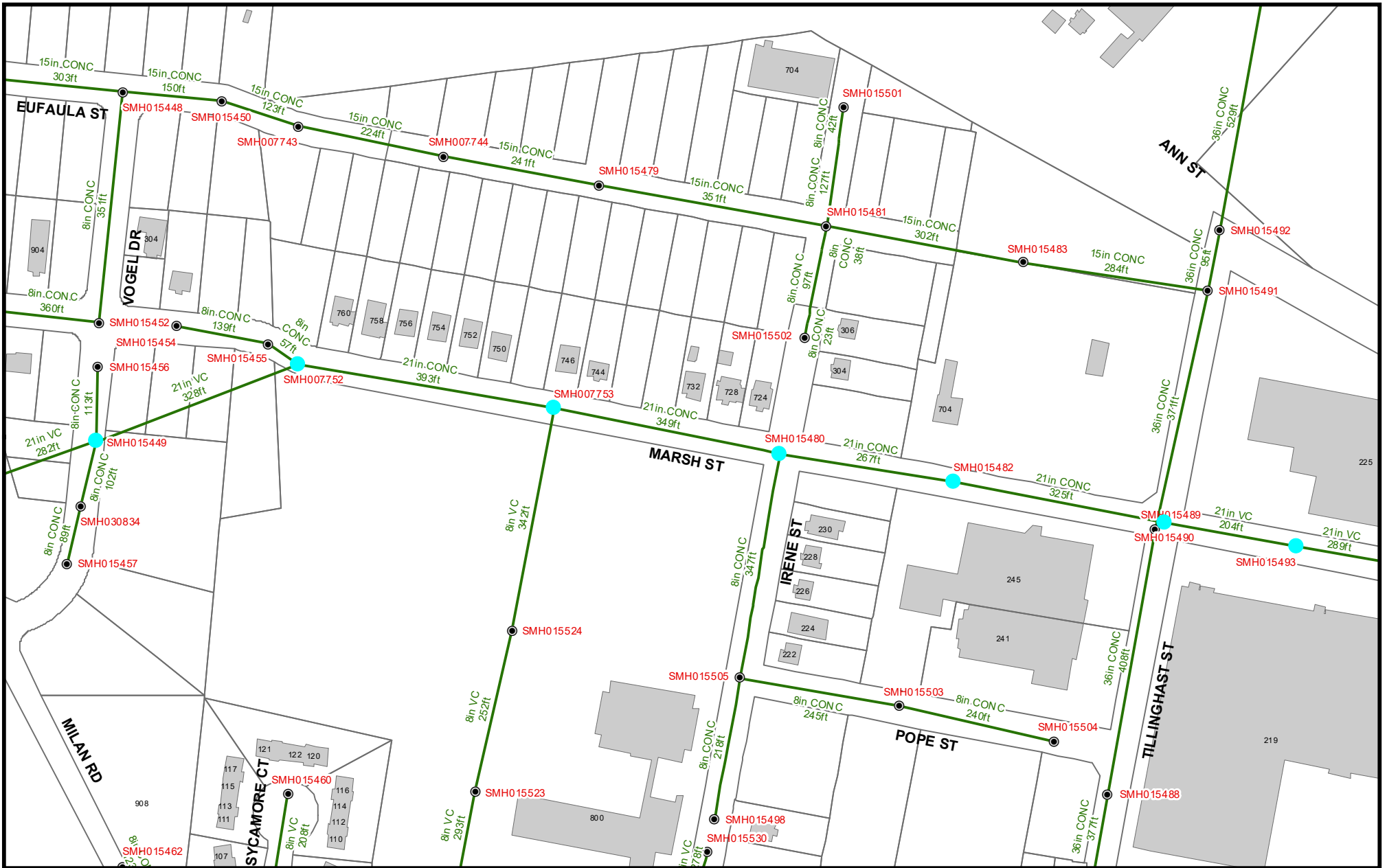

N

8/24/2021

1 inch = 200 feet

Sewer Manhole Rehabilitation 2022

Vogel Drive to N. Eastern Boulevard - Leftover - Map 1

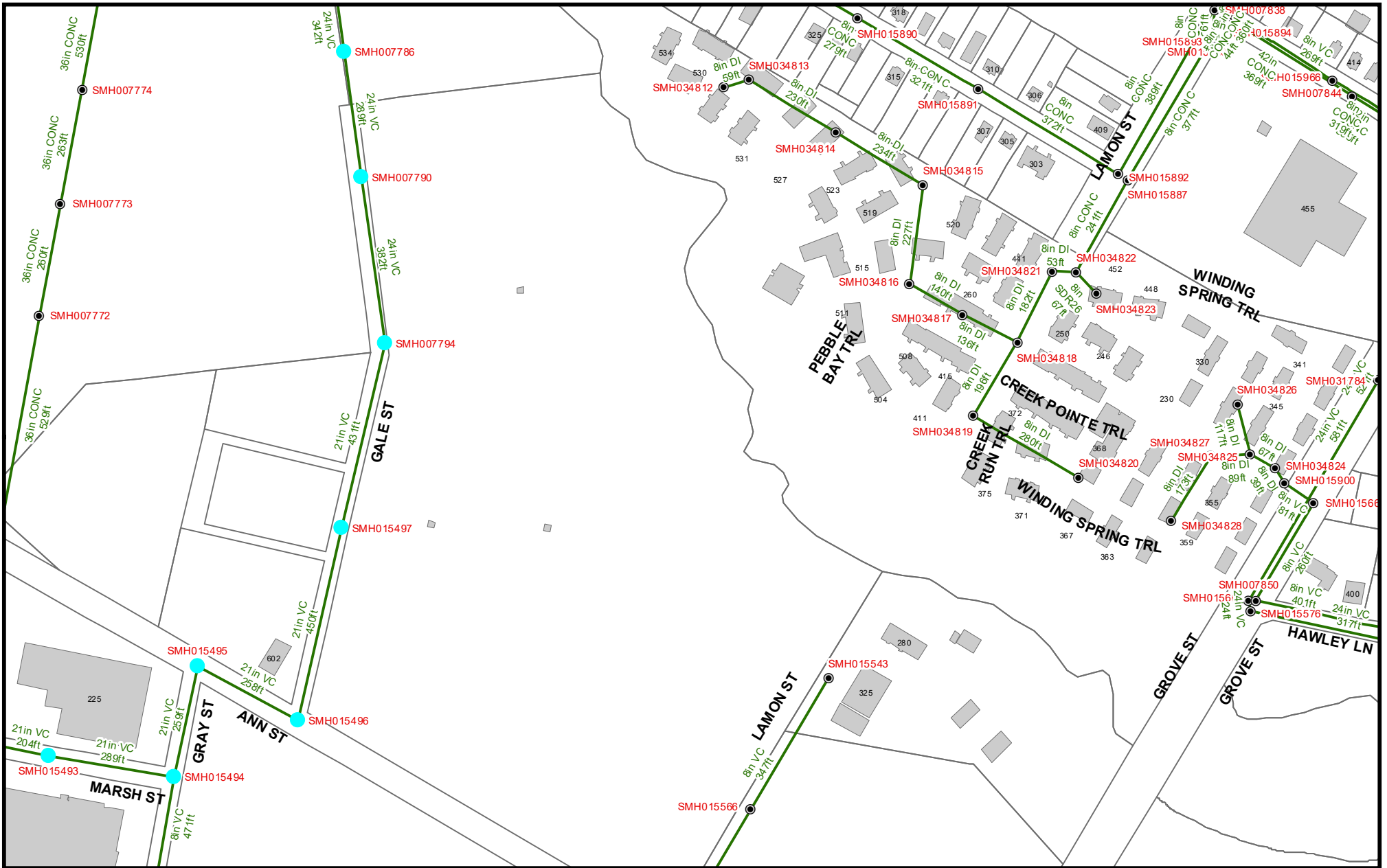





 8/24/2021

 1 inch = 300 feet

Sewer Manhole Rehabilitation 2022

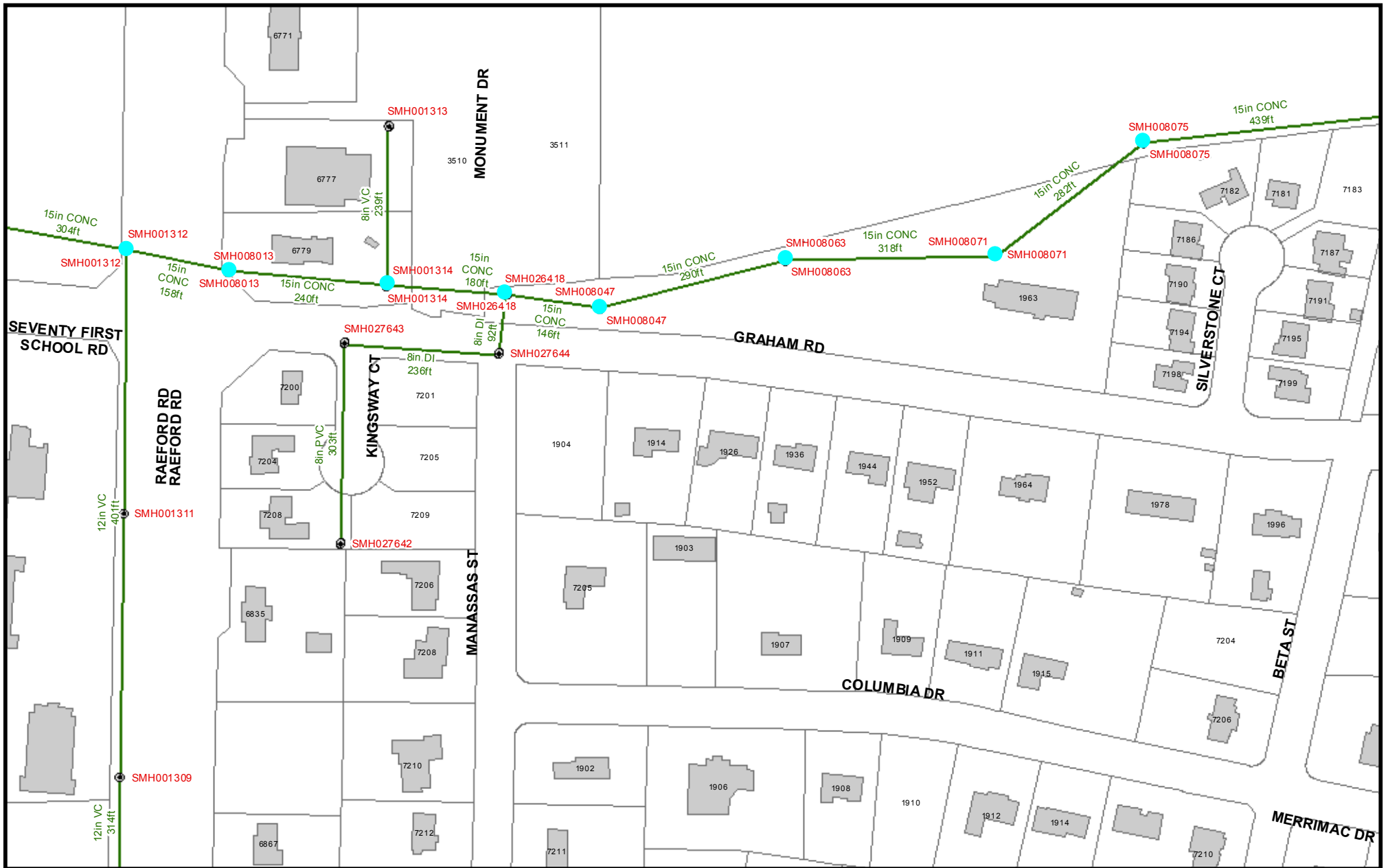
Vogel Drive to N. Eastern Boulevard - Leftover - Map 2



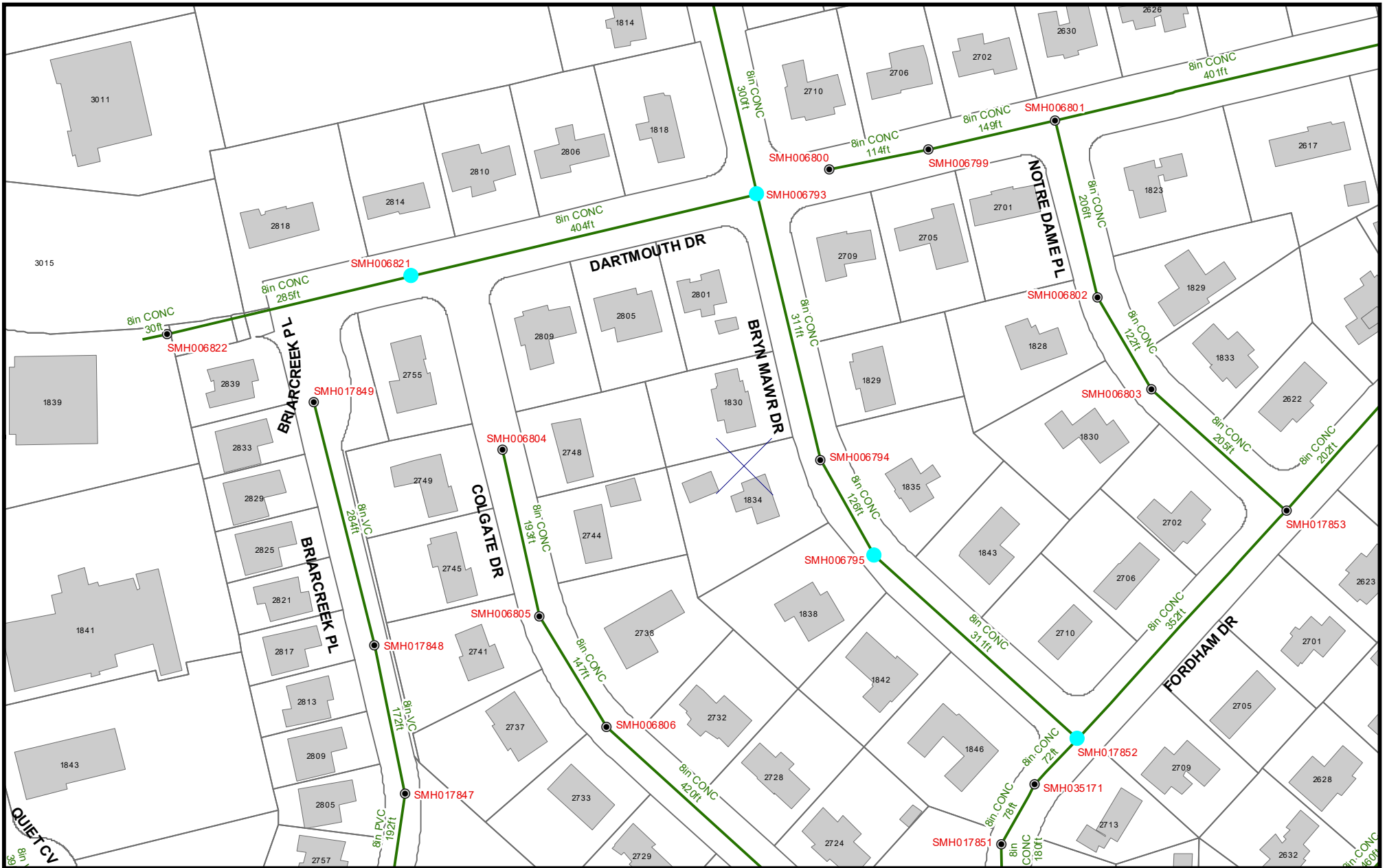

 7/14/2020
 1 inch = 200 feet

Sewer Manhole Rehabilitation 2021 Graham Road - Map 1



N



10/26/2022
1 inch = 150 feet

Sewer Manhole Rehabilitation 2022 Bryn Mawr Drive and Dartmouth Drive

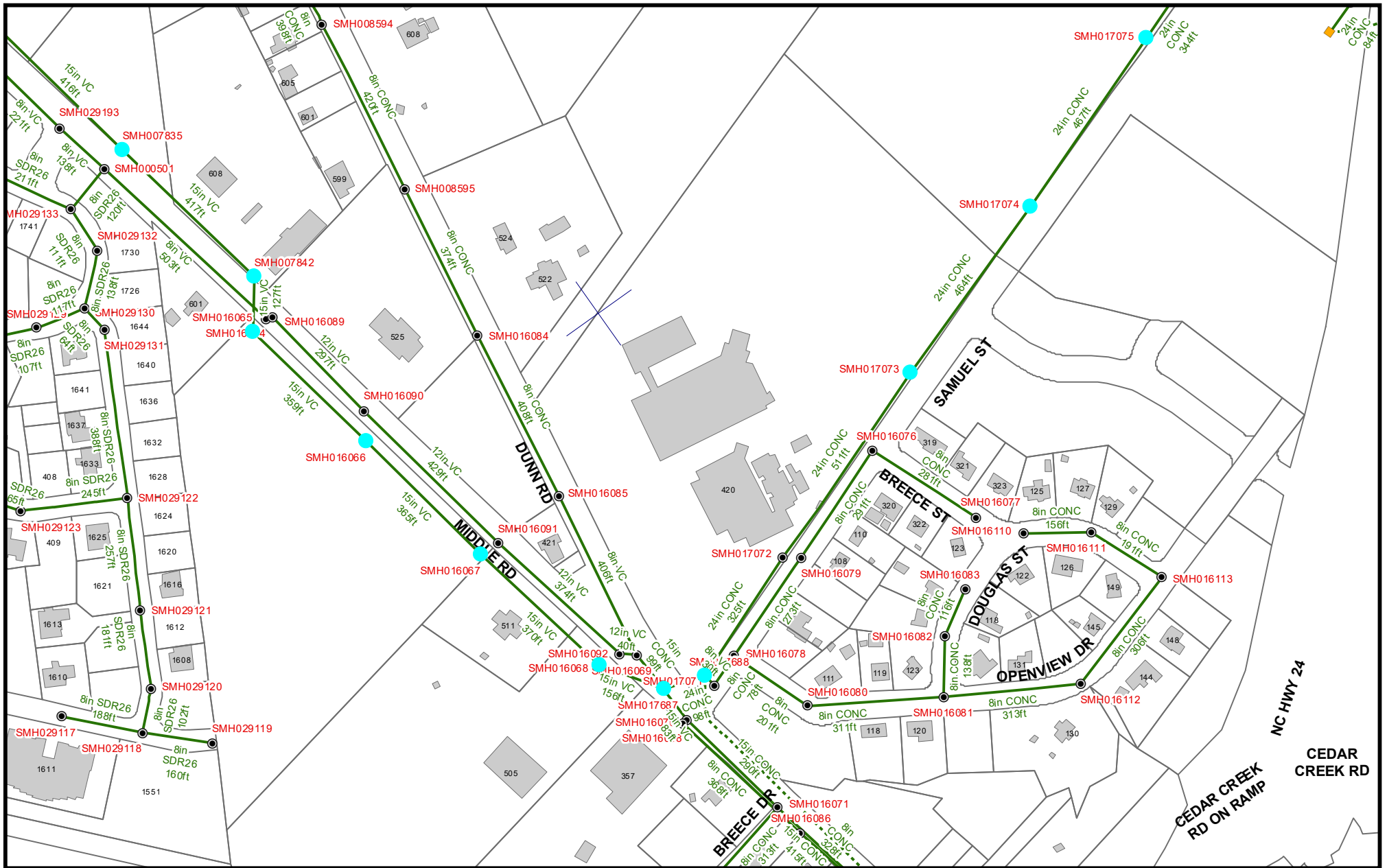

10/26/2022

1 inch = 300 feet

Sewer Manhole Rehabilitation 2022

Dunn Road - Middle Road - Samuel Street - High

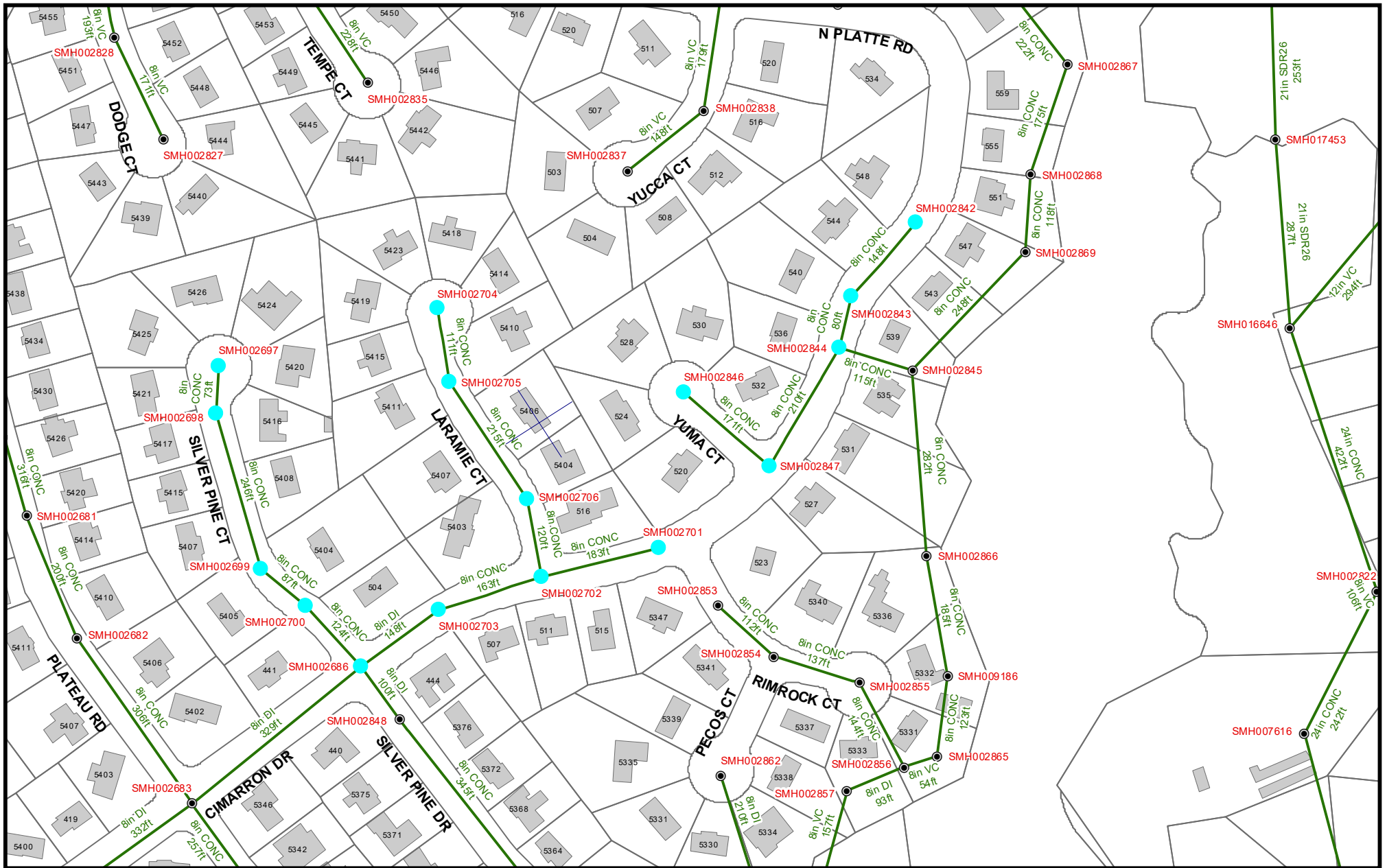

N

10/26/2022
1 inch = 200 feet

Sewer Manhole Rehabilitation 2022 Glenrock Drive to Pecos Court - Leftover - Map 1

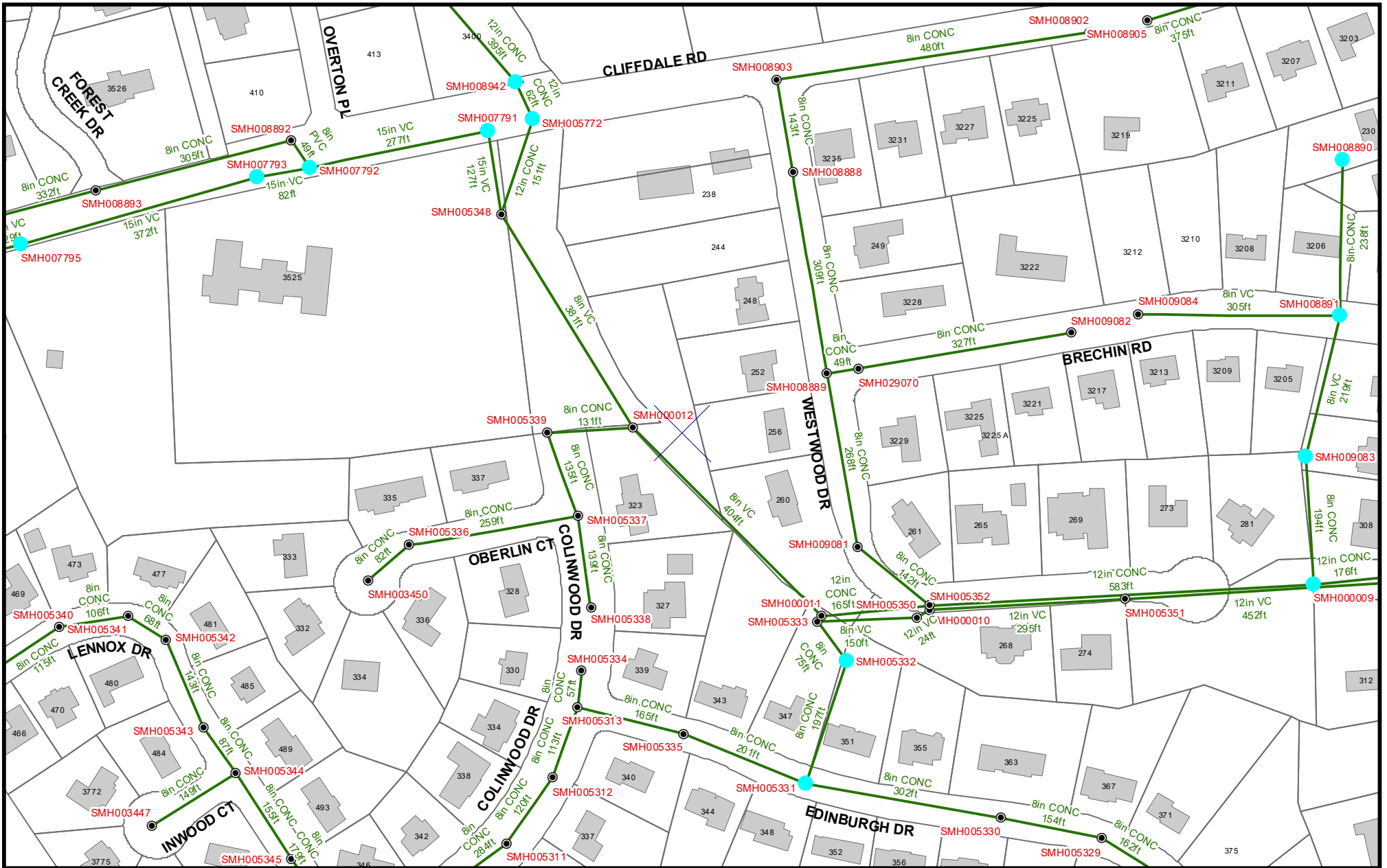

N
10/28/2022
1 inch = 200 feet

Sewer Manhole Rehabilitation 2022 Morganton Road to Murray Hill Road

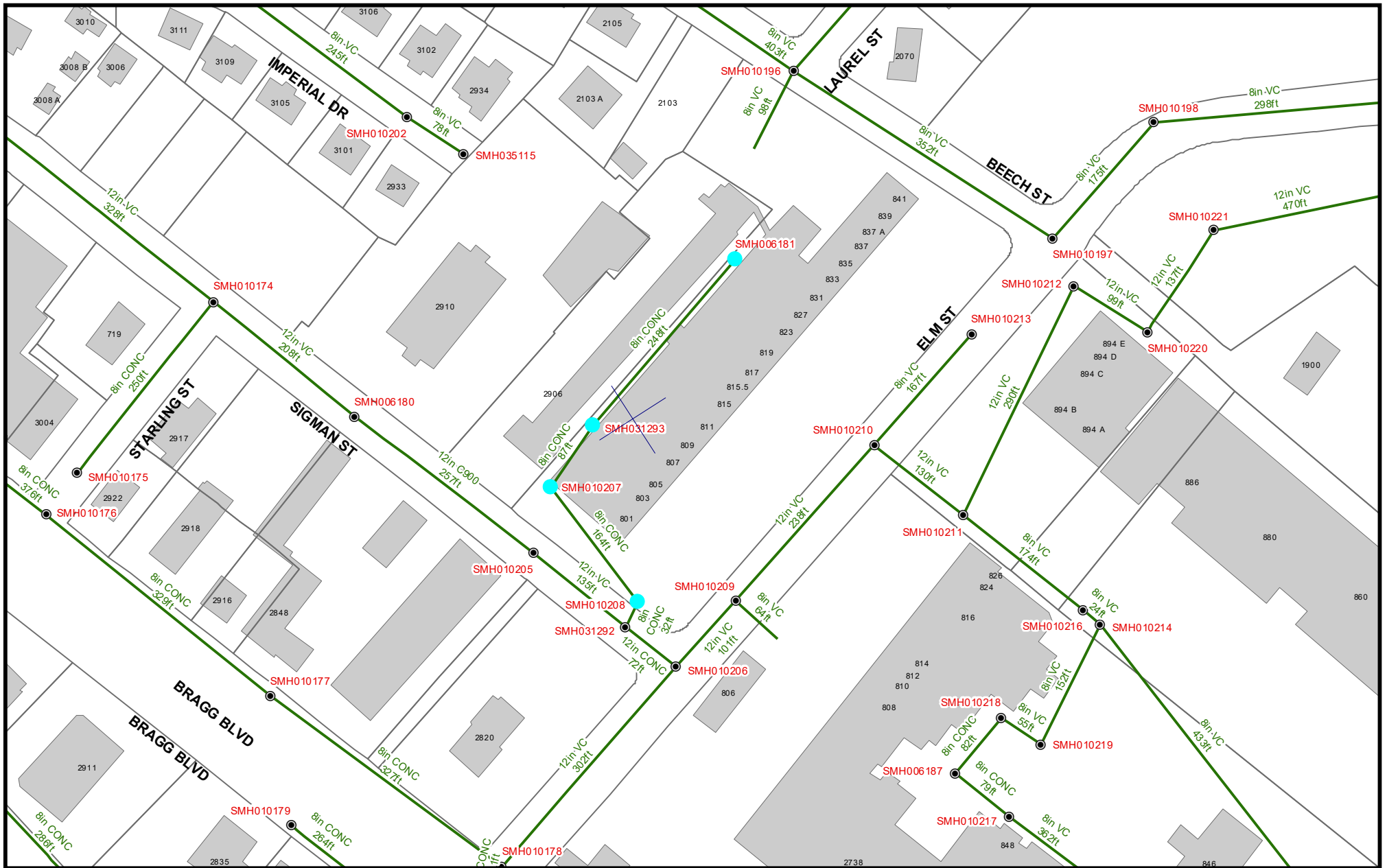

N

 10/26/2022
 1 inch = 150 feet

Sewer Manhole Rehabilitation 2022

Sigman Street behind the McNairy Building - Eutaw Shopping Center

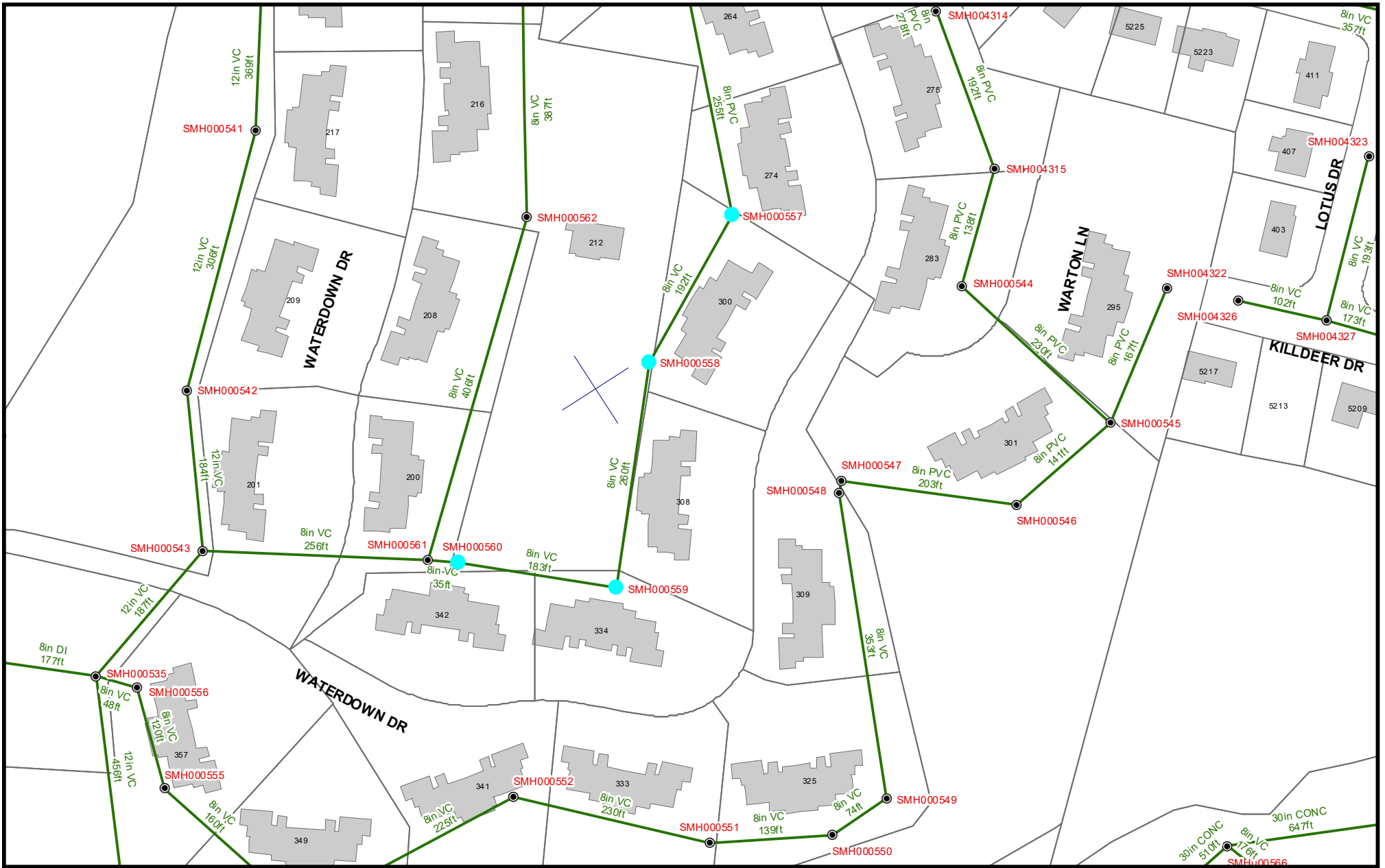

N

10/26/2022
1 inch = 150 feet

Sewer Manhole Rehabilitation 2022 Waterdown Drive - Leftover

**APPENDIX B
CHAIN OF CUSTODY FORM**

CHAIN OF CUSTODY FORM

CIPP LINER TEST SAMPLES

CLIENT: _____

PROJECT: _____

SAMPLE ID: _____ (Must be a unique identification number)

SAMPLE LOCATION: _____ (Manhole Facility ID No.)

SAMPLE TYPE: _____ (Restrained, flat plate)

PIPE DIAMETER (Inches): _____ LINER THICKNESS (mm) _____

Date and Time Sample Taken : ____/____/____ at _____ (AM / PM)

Sample taken by : _____ (Installer signature)

Witnessed by : _____ (PWC Inspector signature)

TEST RESULTS WILL NOT BE ACCEPTED WITHOUT INSPECTOR'S SIGNATURE

SHIPPED BY: _____ (Shipper name) SHIPMENT ID: _____

TESTING LABORATORY: _____ (Lab Name)

TO BE FILLED OUT BY TESTING LAB: (OR ATTACH LAB FORM)

Date sample received : ____/____/____

Date Sample Tested : ____/____/____

Tested by : _____ (Lab technician signature)

Comments : _____

Attach Test Results to This Form and Return to PWC at: 955 Old Wilmington Road
Fayetteville, NC 28301

Attention : John P. Allen, P.E.

Test Results Received by PWC: _____ (PWC PM Signature)

Date Results Received by PWC: ____/____/____

**APPENDIX C
SALES TAX FORM**

PROJECT TITLE _____ Pay App # _____

SALES/USE TAX CERTIFICATE

(Use as many sheets as needed/sign affidavit of last sheet per pay estimate)

Analysis of consumed material **Manufactured or Purchased** by you. Sales and/or Use Tax Regulation Number 41 requires that the City of Fayetteville secure from each contractor certified statements setting forth the cost of the materials and supplies manufactured or purchased by you and consumed in construction. This form is provided for you to list the materials consumed in construction. Please complete this form by inserting the information required below.

<u>Vendor Name</u>	<u>Date Purchased</u>	<u>Invoice Number</u>	<u>Amount Less Tax</u>	<u>Sales Tax % State/ % Local</u>	<u>Invoice Total</u>	<u>County Paid</u>
_____	_____	_____	_____	_____/_____	_____	_____
_____	_____	_____	_____	_____/_____	_____	_____
_____	_____	_____	_____	_____/_____	_____	_____
_____	_____	_____	_____	_____/_____	_____	_____
_____	_____	_____	_____	_____/_____	_____	_____
_____	_____	_____	_____	_____/_____	_____	_____

\$ _____ \$ _____ \$ _____ \$ _____

AFFIDAVIT

This is to certify that sales/use tax was or will be paid as stated above on materials and supplies purchased or manufactured by the **City of Fayetteville, North Carolina**, for the above mentioned project during the period and billed on this payment application # _____

(Contractor)

(Authorized Signature/Date)

(Address)

(Telephone Number)

(City, State, Zip)

(Fax Number)

Date: _____

Page _____ **of** _____