



INVITATION FOR BID

PWC2324061

Distribution Transformer Three Phase Pad Mounts

Date of Issue: February 19, 2024

Date of Opening March 19, 2024

Direct all inquiries concerning this IFB to:

**Shelby Lesane
Procurement Advisor II
procurement@faypwc.com**

Contents

ADVERTISEMENT FOR BID	3
INSTRUCTIONS TO BIDDERS	4
OBJECTIVE OF THE REQUEST	4
IFB SCHEDULE	4
QUESTIONS	4
MINORITY, WOMEN, AND DISADVANTAGED BUSINESS ENTERPRISE (MWDBE) PROGRAM / SMALL LOCAL SUPPLIER (SLS) PROGRAM	4
REFERENCES	6
SUBMISSION INSTRUCTIONS	6
QUANTITIES AND PRICING	7
EVALUATION AND AWARD	7
DELIVERY AND PAYMENT	8
ATTACHMENT A: DETAILED SPECIFICATIONS	9
ATTACHMENT B: BID PRICING FORM	10
ATTACHMENT D: AT A GLANCE	13
ATTACHMENT E: PWC SALE OF GOOD AGREEMENT	14
ATTACHMENT F: MWDBE AFFIDAVITS	15
ATTACHMENT G: SMALL LOCAL SUPPLIER/MWDBE SUBCONTRACTOR DISCLOSURE FORM	16

**ADVERTISEMENT FOR BID
FAYETTEVILLE PUBLIC WORKS COMMISSION
DISTRIBUTION TRANSFORMER THREE PHASE PAD MOUNTS**

**Cumberland County
North Carolina**

Bids are solicited and will be received at Fayetteville Public Works Commission, Administration Building, Procurement Department/Conference Room 107, 955 Old Wilmington Road, Fayetteville, NC 28301, until **2:00 p.m., EST Tuesday, March 19, 2024**, for the **DISTRIBUTION TRANSFORMER THREE PHASE PAD MOUNTS**.

Enclosed please find the Instructions to Bidders, Detailed Specifications, and Bid Pricing Form. Bids shall be submitted on the forms provided herein, or exact copies thereof, and the bidder shall return one copy of the entire bid packet along with the completed Bid Pricing Form and any other information specified in the bid documents.

Questions regarding this bid must be submitted in writing to the attention of Shelby Lesane, at procurement@faypwc.com no later than **5:00 p.m., Tuesday, March 5, 2024** in order to be considered for a response.

Mailed bids must be addressed to **Shelby Lesane**, Procurement Advisor II, Fayetteville Public Works Commission, 955 Old Wilmington Road, Fayetteville, North Carolina 28301. The outside of the envelope must be marked **BID: PWC2324061 DISTRIBUTION TRANSFORMER THREE PHASE PAD MOUNTS** shall indicate the name, and address of the bidder.

Fayetteville Public Works Commission reserves the right to reject any or all bids for any reason determined by PWC to be in its best interest, or to award the bid to the lowest responsible bidder or bidders, taking into consideration quality, performance, and the time specified in the bids for the performance of the contract.

FAYETTEVILLE PUBLIC WORKS COMMISSION
Victoria McAllister
Procurement Manager

**INSTRUCTIONS TO BIDDERS
FAYETTEVILLE PUBLIC WORKS COMMISSION
DISTRIBUTION TRANSFORMERS THREE PHASE PAD MOUNTS**

OBJECTIVE OF THE REQUEST

It is the intent of this bid invitation to obtain pricing for **DISTRIBUTION TRANSFORMER THREE PHASE PAD MOUNTS** within the detailed specifications section of this Invitation for Bid (IFB). You are requested to submit your bid on the enclosed Bid Pricing Form.

IFB SCHEDULE

The following table shows the schedule of events to prepare your organization’s response. The key deadlines and targeted dates for this process are as follows:

Action	Responsibility	Date/Time
Submit Written Questions	Bidders	Tuesday, March 5, 2024 @ 5:00 pm
Provide Response to Questions	PWC	Thursday, March 7, 2024 @ 5:00 pm
Submit IFB	Bidders	Tuesday, March 19, 2024 @ 2:00 pm
Target Commission Date	PWC	Wednesday, April 10, 2024
Target Council Date	PWC	Monday, April 22, 2024
Award /Sale of Goods Agreement	PWC	TBD

QUESTIONS

Written questions shall be e-mailed to procurement@faypwc.com by the date and time specified in the IFB schedule. Bidders will enter “IFB **PWC2324061** – Questions” as the subject of the email.

Questions received prior to the submission deadline date, the Procurement Advisor’s response, and any additional information deemed necessary by PWC will be posted in the form of an addendum to the PWC website and shall become an Addendum to this IFB. No information, instruction, or advice provided orally or informally by any PWC personnel, whether made in response to a question or otherwise concerning this IFB, shall be considered authoritative or binding. Firms shall rely only on written material contained in an Addendum to this IFB.

Inquiries should be submitted no later than the date and time noted in the IFB schedule. Questions answered verbally will be followed up by written addenda as deemed necessary; oral interpretations shall have no effect.

MINORITY, WOMEN, AND DISADVANTAGED BUSINESS ENTERPRISE (MWD BE) PROGRAM / SMALL LOCAL SUPPLIER (SLS) PROGRAM

PWC is committed to promoting the utilization of Minority, Women, and Disadvantaged Businesses in PWC’s geographical statistical area (GSA) by providing equal opportunity for participating in all aspects of PWC’s contracting and procurement programs. The GSA consists of NCDOT division areas 3-8, and 10. PWC is also committed to promoting the utilization of small, local businesses in the Fayetteville Metropolitan Statistical Area (MSA) by increasing opportunities for those businesses to participate in PWC procurements. The MSA consists of Cumberland County, Hoke County, and Harnett County.

PWC requires Firms to report efforts to utilize Minority, Women, and Disadvantaged Business Enterprises (MWDBEs) and Historically Underutilized Businesses (HUBs) for specific projects and requires all Firms to report all such efforts for MWDBEs, HUBs, and Small Local Suppliers regardless of the requirements of a specific project. Bidders shall document any good-faith efforts and utilization in the MWDBE forms provided within Attachment F.

In accordance with PWC's MWDBE Program, the goal shall be to award four percent (4%) of the total contract dollars to MBE firms and four percent (4%) to WBE firms. A complete copy of PWC's MWDBE Program is available for inspection at PWC Procurement Department.

The following is a list of the efforts that should be made by the prime service provider to encourage MWDBE participation. In order to receive credit for having made "good faith efforts", the prime service provider should document all actions taken to include the following:

- 1) Attending pre-bid meetings scheduled by the department;
- 2) Identifying selected specific items of the project which could be executed by a MWDBE;
- 3) Soliciting MWDBE service provider participation in a reasonable time before the proposals are due through advertisements in circulation media, trade publications, and minority-focused media;
- 4) Contacting local firms, firms owned by minorities or women, and associations or business development centers which disseminate information to local businesses and businesses owned by minorities or women in a timely manner to allow sufficient time for MWDBEs to respond;
- 5) Following up on initial solicitations of interest by contacting the MWDBE to determine whether the MWDBE was interested in performing specific items of the project;
- 6) Attempting to enter into joint venture or partnership arrangements with MWDBEs and provide interested MWDBEs with information about the requirements for the project;
- 7) Providing assistance to MWDBEs in the review of proposals and work to be done by sub-service providers;
- 8) Using available directories of certified MWDBEs and other available resources;
- 9) Ensuring that the proposer negotiated in good faith with the MWDBE and did not unjustifiably reject as unsatisfactory quotes prepared by any Minority, Women, or Disadvantaged Business Enterprise;
- 10) Making every effort to obtain Minority, Women, or Disadvantaged Business Enterprise participation that could reasonably be expected to produce a level of participation sufficient to meet the goals of PWC; and
- 11) Providing interested minority, women, and disadvantaged businesses with information relative to project requirements

REFERENCES

Bidders shall provide at least three (3) different references for which your company has supplied the exact model of equipment offered. PWC may contact these references to determine the commodity provided are substantially similar in scope to those requested in Attachment A and that the bidder's performance has been satisfactory. The information obtained shall be considered in the evaluation of the bid. If PWC is referenced, it cannot be counted towards your three (3) required references but may be included in addition to.

COMPANY NAME	CONTACT NAME	TELEPHONE NUMBER	EMAIL
Fayetteville Public Works Commission, if applicable			

SUBMISSION INSTRUCTIONS

- 1) Bids should be complete and carefully worded and should convey all the information requested in the IFB. Bids should be prepared simply and economically, providing a straightforward, concise description of the bidder's capabilities to satisfy the requirements of the IFB. Emphasis should be on completeness and clarity of content. If the bid includes any comment over and above the specific information requested in the IFB, the bidder should include this information as a separate appendix to its bid. Bids that include clarifications or modifications to any of the IFB's contractual requirements, or a bidder's standard terms and conditions, may be deemed non-responsive and not considered for award at PWC's discretion. Unsolicited bid samples or descriptive literature will not be examined or tested, will not be used to determine responsiveness, and will not be deemed to vary any of the provisions of the IFB. Failure to comply with these requirements shall constitute sufficient cause to reject a bid without further consideration. PWC reserves the right to accept or reject any bid and to annul the bidding process and reject all bids at any time prior to award of a Sale of Goods Agreement, without thereby incurring any liability to the affected bidder or bidders or any obligation to inform the affected bidder or bidders the reasons for PWC's action.
- 2) Bids may be withdrawn by the bidder only in writing and if receipt of such withdrawal is acknowledged by PWC prior to the time for the bid submittal deadline identified in the Advertisement for Bidders (or such later date included in an Addendum). Written withdrawal requests shall be submitted on the bidder's letterhead and signed by an official of the bidder duly authorized to make such request. Any withdrawal request made after the bid submittal deadline shall be allowed only if the price bid was based upon a mistake that constituted a substantial error, provided the bid was submitted in good faith, and then only pursuant to the terms of N.C.G.S. § 143-129.1.
- 3) Bids submitted in an envelope must have the bid title, date, and time of the bid submittal deadline on the front of the envelope no later than the bid due date and time. The bid will be due at **Fayetteville Public Works Commission, Administration Building, Procurement**

Department, 955 Old Wilmington Road, Fayetteville, NC 28301.

- 4) Bids will be examined promptly after the due date and an award will be made at the earliest possible date. Bids must be held firm for PWC for a period of sixty (60) days after the bid due date. A purchase order will be issued to the awarded bidder.
- 5) Bidders shall submit bids only on the Bid Pricing Forms provided herein, or exact copies thereof (**See Exhibit B – Bid Pricing Form**). Failure to provide full and complete Bid Pricing Forms may result in a bid being deemed non-responsive.
- 6) All bids must be signed by an authorized official of the bidder. Bids may be rejected for any omission, alteration of form, additions not called for, conditional bid, or any irregularities of any kind.
- 7) Do not submit alternate bids unless specifically called for on the Bid Pricing Forms or Detailed Specifications.

QUANTITIES AND PRICING

- 1) Quantities listed are estimates for forecasted projects.
- 2) All bidders are advised to include all costs incurred by the bidder in delivering the **DISTRIBUTION TRANSFORMER THREE PHASE PAD MOUNTS** to the **PWC WAREHOUSE** their bid submittal. The invoice submitted for payment shall not reflect any other costs (fuel surcharge, toll, etc.).
- 3) Bidder shall submit pricing for each transformer size. Pricing shall be referenced to one of the following indices (each an "Index"): (a) the BLS index for 'Electric Power and Specialty Transformer Manufacturing: Power and Distribution Transformers, Except Parts (PCU3353113353111); or (b) another verifiable, relevant and nationally recognized pricing index reasonably acceptable to PWC. Each Index shall be verifiable via the website links submitted by Bidder in its bid. The proposed Index shall be noted in the bid and shall be the Index utilized during the term of the Contract.

EVALUATION AND AWARD

- 1) An award of a contract is subject to the approval by the Board of Commissioners of PWC and the Fayetteville, North Carolina City Council.
- 2) PWC reserves the right to inspect, at a reasonable time, the equipment, item, plant, or other facilities of a prospective Bidder prior to award, and during the Sale of Goods Agreement term, as PWC deems necessary to determine that such equipment, item, plant, or other facilities conform with the specifications/requirements and are adequate and suitable for the proper and effective performance of the Sale of Goods Agreement.
- 3) PWC reserves the right to request additional information from bidders to aid in the evaluation process. This information may include but is not limited to, financial statements, a reference list of contracts of similar size, etc.
- 4) PWC reserves the right to make a single award for all items or may award separate contracts

to multiple bidders for various items to the lowest responsive, responsible bidder or bidders, taking into consideration product quality, performance to PWC, and conformity with the specifications in these bid documents. PWC may also consider, among other things, the Bidder's past performance conduct on other contracts, and other information as PWC deems necessary to assist in the evaluation of any bid.

- 5) The Sale of Goods Agreement will be awarded on or about April 24, 2024.
- 6) The term of the Contract shall extend from the date of execution and delivery of the Contract by all parties through the date of delivery of transformers through April 31, 2025; provided, however, that by written notice by a party not less than ___ days prior to the then existing term, and the receiving party's written acknowledge and agreement to such notice of extension. Delivery of Goods shall take place during the term of the Contract.

DELIVERY AND PAYMENT

- 1) Delivery to be made F.O.B. Public Works Commission **1097 Public Works Drive, Fayetteville NC, 28301.**
- 2) Deliveries shall be made between the hours of **9:00 a.m. and 3:00 p.m., Monday through Friday**, within the time frame specified on the Bid Pricing Form.
- 3) Payment for equipment, material, supplies, etc. purchased pursuant to this bid shall be made by Public Works Commission approximately thirty days after the same has been delivered, inspected, approved and the invoice received in the PWC Accounts Payable Office, P.O. Box 1089, Fayetteville, North Carolina 28302.

**Public Works Commission
Fayetteville, NC
Electric Systems Division
Material Specification**

TRANSFORMER, PAD-MOUNT, 3-PHASE, 12KV

**Revision Date: February 7, 2024
Revised By: Glenn Andersen
Page 1 of 4**

(Reference Table 4 on Page 2 for PWC Stock Codes, Ratings and Property Types)

Description: Pad mounted, compartmental-type, loop-feed, ONAN, three-phase 60 hertz dual primary voltage Y-Y secondary voltage distribution transformer for use on 12470GRDY/7200 systems under usual service conditions. Unit will be standard side-by-side, primary/secondary configuration with inside dimensions according to IEEE C57.12.34 Figure 16 with bails. Overall dimensions shall be 52"-80" wide and 80" maximum deep including radiators for 750 KVA and below, and 72"-92" wide and 92" maximum deep including radiators for 1000 KVA, 1500 KVA, and 2500 KVA, and will be constructed in general accordance with IEEE C57.12.34. Depth of the Primary/Secondary Cabinet 24" minimum for all KVA Sizes.

There shall be no hold-down tabs in the Primary/Secondary Cabinet protruding from the tank or the flanges into the Primary/Secondary space.

Efficiency Standard: All transformers supplied shall meet minimum efficiency standards set forth in the Department of Energy (DOE) 2016 Energy Efficiency Standard of the Energy Policy and Conservation Act.

Bushings and Terminals: Six primary bushing wells (H1A,2A,3A) and (H1B,2B,3B) connected internally per IEEE C57.12.34 to accept 25KV Rated separable insulated connector bushings and accessories conforming to ANSI/IEEE Standard 386; and conforming to dimensions as shown in Figure 16 in IEEE C57.12.34 and as shown on Page 3. Transformers shall have eight (8) single-accessory parking stands; Four (4) low-voltage externally clamped spade-type bushing terminals (H0X0,1,2,3) as shown in Figure 8(A) in IEEE C57.12.34 and as shown in the table on Page 3, and two (2) 2-hole NEMA tank grounding pads/connectors per IEEE C57.12.34.

Accessory Equipment: Transformer shall have lifting provisions per IEEE C57.12.34, three oil-immersed load break hook-stick operated Bay-O-Net type fuses sized to remove the transformer from the line in case of severe overload and internal faults, a pressure relief device per IEEE C57.12.34, an oil level indicator, oil drain (located in the lower left corner of the primary compartment), fill and sampling provisions, and a standard diagrammatic nameplate with bar coded serial number, PWC Company number and PWC stock number. A duplicate nameplate shall be placed on the outside rear corner of the transformer. Also, install the PWC Company Number decal (3.5" x 9" label) on the lower middle of the primary compartment door as shown on Page 4 of 4. Decals will be provided by PWC. A minimum of one (1) handhole large enough to allow replacement of all primary and secondary bushings, or a bolted cover shall be included.

Taps: 1000kVA, 1500kVA, and 2500kVA Transformers shall have straddle taps, two (2) 2.5% above nominal, and two (2) 2.5% below nominal voltage using a gasketed three-phase ABCDE tap changer within the primary compartment for de-energized selection of each primary voltage tap position

Polarity and Terminal Markings: Per IEEE C57.12.70

Oil Preservation: Per IEEE C57.12.34.

TRANSFORMER, PAD-MOUNT, 3-PHASE, 12KV

Revision Date: February 7, 2024

**Public Works Commission
Fayetteville, NC
Electric Systems Division
Material Specification**

**Revised By: Glenn Andersen
Page 2 of 4**

Tank: Domed or peak-roofed carbon steel welded-seam door and tank with primary and secondary compartments, per IEEE C57.12.34, and conforming to enclosure security requirements per IEEE C57.12.28.

Finish: Wash, primer, and Munsell 7GY 3.29/1.5 Green baked powder finish coat(s) in accordance with IEEE C57.12.28.

Performance Standards:

Rated capacity: Per IEEE C57.12.00 (Design Test)

Basic Impulse Level: 95/30 kV Primary/Secondary (Design Test)

Tests: Successful completion of routine tests per IEEE C57.12.00

Delivery Standards: Transformers will be securely strapped to pallets and delivered FOB destination as directed by PWC Warehouse personnel. All transformers shall be accompanied by certified test results in IEEE C57.12.37 format (comma delimited or Excel spreadsheet) electronically and sent to Elbert.Norris@faypwc.com in accordance with PWC Apparatus Shop Specifications. Transformers should be shipped on open-body trailers to be unloaded by crane, line truck or forklift from trailer side. PWC Warehouse personnel will be notified 24 hours in advance of delivery (910-223-4355)

Table 4						
Stock Code	Type	KVA	Primary (kV)	Primary/Secondary BIL (kV)	Secondary (V)	Property Type
1-295-660	3-Ph Pad	150	12470GRDY/7200	95/30	208Y/120	41168
1-295-700	3-Ph Pad	300	12470GRDY/7200	95/30	208Y/120	41568
1-295-720	3-Ph Pad	500	12470GRDY/7200	95/30	208Y/120	41768
1-295-737	3-Ph Pad	750	12470GRDY/7200	95/30	208Y/120	41868
1-295-665	3-Ph Pad	150	12470GRDY/7200	95/30	480Y/277	41171
1-295-705	3-Ph Pad	300	12470GRDY/7200	95/30	480Y/277	41571
1-295-725	3-Ph Pad	500	12470GRDY/7200	95/30	480Y/277	41771
1-295-740	3-Ph Pad	750	12470GRDY/7200	95/30	480Y/277	41871
1-295-750	3-Ph Pad	1000	12470GRDY/7200 w/Taps	95/30	480Y/277	41971
1-295-765	3-Ph Pad	1500	12470GRDY/7200 w/Taps	95/30	480Y/277	42071
1-295-786	3-Ph Pad	2500	12470GRDY/7200 w/Taps	95/30	480Y/277	42171

Specification reviewed by: _____

Public Works Commission
 Fayetteville, NC
 Electric Systems Division
 Material Specification

Revised By: Glenn Andersen
 Page 3 of 4

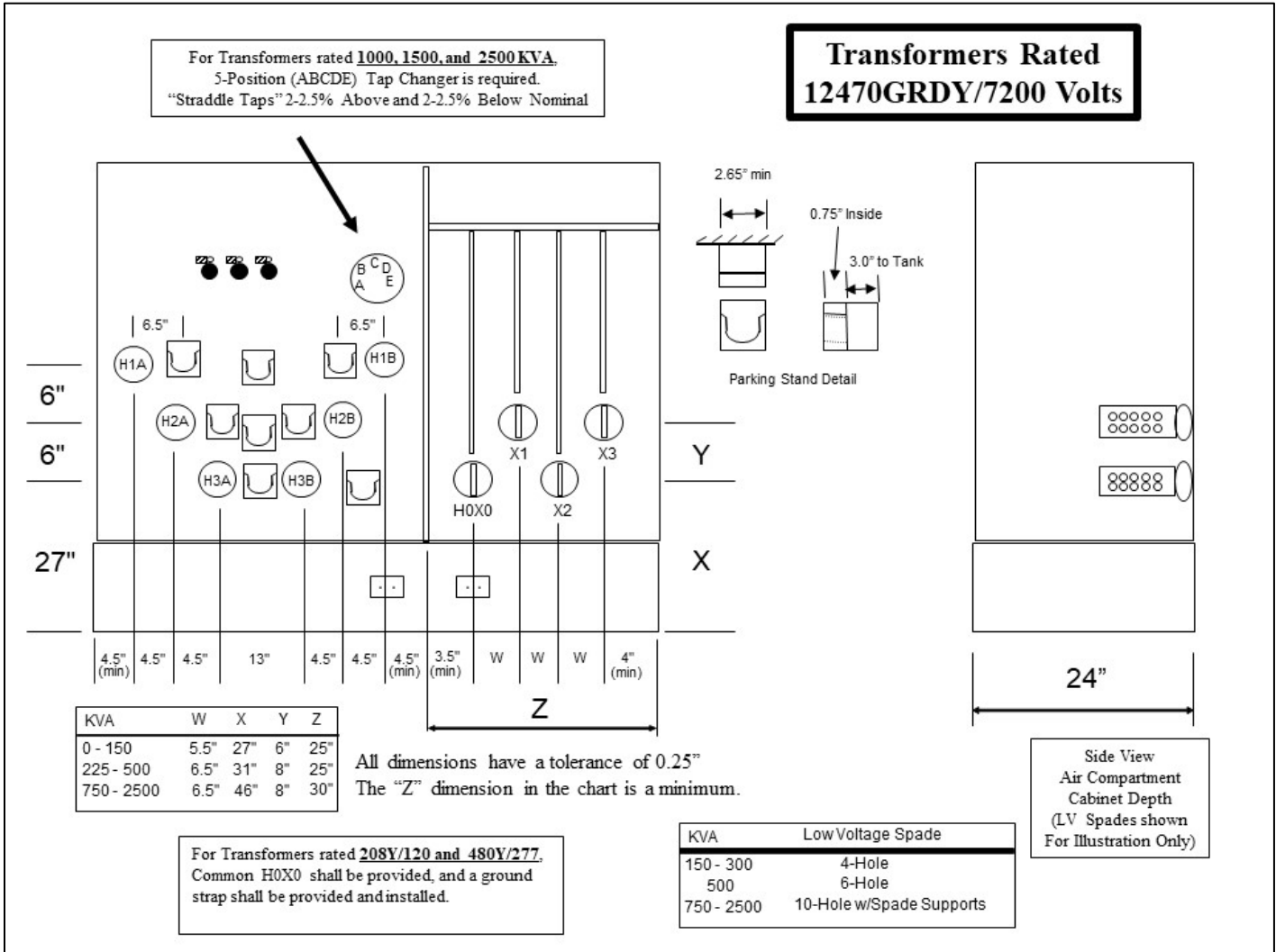

Public Works Commission
Fayetteville, NC
Electric Systems Division
Material Specification

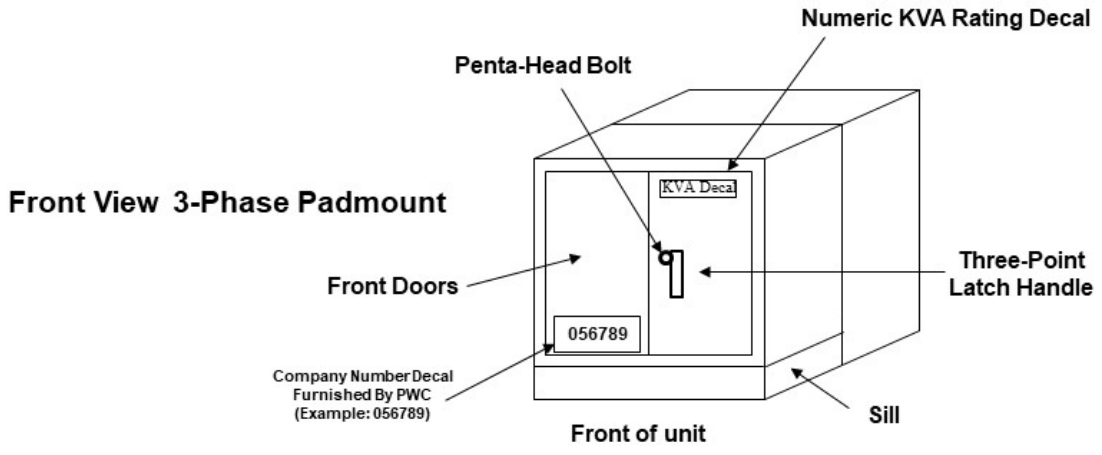

Rear View 3-Phase Padmount

**Duplicate Nameplate Location
for 3-Phase Padmounts**

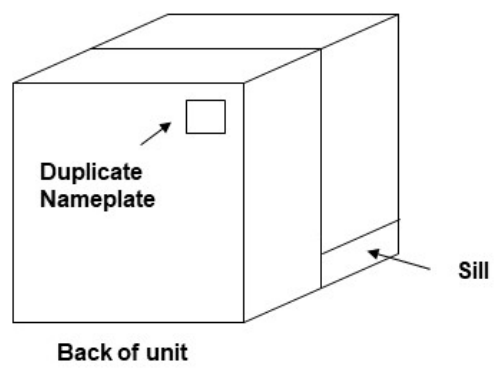

**Public Works Commission
Fayetteville, NC
Electric Systems Division
Material Specification**

TRANSFORMER, PAD-MOUNT, 3-PHASE, 12X24KV

**Revision Date: February 7, 2024
Revised By: Glenn Andersen
Page 1 of 4**

(Reference Table 3 on Page 2 for PWC Stock Codes, Ratings and Property Types)

Description: Pad mounted, compartmental-type, loop-feed, ONAN, three-phase 60 hertz dual primary voltage Y-Y secondary voltage distribution transformer for use on 12470GRDY/7200 or 24940GRDY/14400 Volt systems under usual service conditions. Unit will be standard side-by-side, primary/secondary configuration with inside dimensions according to IEEE C57.12.34 Figure 16 with bails. Overall dimensions shall be 52"-80" wide and 80" maximum deep including radiators for 750 KVA and below, and 72"-92" wide and 92" maximum deep including radiators for 1000 KVA, 1500 KVA, and 2500 KVA, and will be constructed in general accordance with IEEE C57.12.34. Depth of the Primary/Secondary Cabinet shall be 24" minimum for all KVA Sizes.

There shall be no hold-down tabs in the Primary/Secondary Cabinet protruding from the tank or the flanges into the Primary/Secondary space.

Efficiency Standard: All transformers supplied shall meet minimum efficiency standards set forth in the Department of Energy (DOE) 2016 Energy Efficiency Standard of the Energy Policy and Conservation Act.

Bushings and Terminals: Six primary bushing wells (H1A,2A,3A) and (H1B,2B,3B) connected internally per IEEE C57.12.34 to accept 25KV Rated separable insulated connector bushings and accessories conforming to ANSI/IEEE Standard 386; and conforming to dimensions as shown in Figure 16 in IEEE C57.12.34 and as shown on Page 3. Transformers shall have eight (8) single-accessory parking stands; Four (4) low-voltage externally clamped spade-type bushing terminals (H0X0,1,2,3) as shown in Figure 8(A) in IEEE C57.12.34 and as shown in the table on Page 3, and two (2) 2-hole NEMA tank grounding pads/connectors per IEEE C57.12.34.

Accessory Equipment: Transformer will have a gasketed three-phase dual voltage switch within the primary compartment for de-energized selection of 12470GRDY/7200 or 24940GRDY/14400 primary voltage, lifting provisions per IEEE C57.12.34, three oil-immersed load break hook-stick operated Bay-O-Net type fuses sized to remove the transformer from the line in case of severe overload and internal faults, a pressure relief device per IEEE C57.12.34, an oil level indicator, oil drain (located in the lower left corner of the primary compartment), fill and sampling provisions, and a standard diagrammatic nameplate with bar coded serial number, PWC Company number and PWC stock number. A duplicate nameplate shall be placed on the outside rear corner of the transformer. Also, install the PWC Company Number decal (3.5" x 9" label) on the lower middle of the primary compartment door as shown on Page 4 of 4. Decals will be provided by PWC. A minimum of either one (1) handhole large enough to allow replacement of all primary and secondary bushings, or a bolted cover shall be included. The dual voltage switch positions shall be labelled "12KV" and "24KV" using either stenciling or adhesive decals.

Polarity and Terminal Markings: Per IEEE C57.12.70

Oil Preservation: Per IEEE C57.12.34.

**Public Works Commission
Fayetteville, NC
Electric Systems Division
Material Specification**

TRANSFORMER, PAD-MOUNT, 3-PHASE, 12X24KV

**Revision Date: February 7, 2024
Revised By: Glenn Andersen
Page 2 of 4**

Tank: Domed or peak-roofed carbon steel welded-seam door and tank with primary and secondary compartments, per IEEE C57.12.34, and conforming to enclosure security requirements per IEEE C57.12.28.

Finish: Wash, primer, and Munsell 7GY 3.29/1.5 Green baked powder finish coat(s) in accordance with IEEE C57.12.28.

Performance Standards:

Rated capacity: Per IEEE C57.12.00 (Design Test)
Basic Impulse Level: 125/30 kV Primary/Secondary (Design Test)
Tests: Successful completion of routine tests per IEEE C57.12.00

Delivery Standards: Transformers will be securely strapped to pallets and delivered FOB destination as directed by PWC Warehouse personnel. All transformers shall be accompanied by certified test results in IEEE C57.12.37 format (comma delimited or Excel spreadsheet) electronically and sent to Elbert.Norris@faypwc.com in accordance with PWC Apparatus Shop Specifications. Transformers should be shipped on open-body trailers to be unloaded by crane, line truck or forklift from trailer side. PWC Warehouse personnel will be notified 24 hours in advance of delivery (910-223-4355)

Table 3						
Stock Code	Type	KVA	Primary (kV)	Primary/Secondary BIL (kV)	Secondary (V)	Property Type
1-295-670	3-Ph Pad	150	12470GRDY/7200 X 24940GRDY/14400	125/30	208Y/120	41172
1-295-701	3-Ph Pad	300	12470GRDY/7200 X 24940GRDY/14400	125/30	208Y/120	41572
1-295-721	3-Ph Pad	500	12470GRDY/7200 X 24940GRDY/14400	125/30	208Y/120	41772
1-295-747	3-Ph Pad	750	12470GRDY/7200 X 24940GRDY/14400	125/30	208Y/120	41872
1-295-677	3-Ph Pad	150	12470GRDY/7200 X 24940GRDY/14400	125/30	480Y/277	41125
1-295-706	3-Ph Pad	300	12470GRDY/7200 X 24940GRDY/14400	125/30	480Y/277	41525
1-295-732	3-Ph Pad	500	12470GRDY/7200 X 24940GRDY/14400	125/30	480Y/277	41725
1-295-741	3-Ph Pad	750	12470GRDY/7200 X 24940GRDY/14400	125/30	480Y/277	41825
1-295-755	3-Ph Pad	1000	12470GRDY/7200 X 24940GRDY/14400	125/30	480Y/277	41925
1-295-770	3-Ph Pad	1500	12470GRDY/7200 X 24940GRDY/14400	125/30	480Y/277	42025
1-295-785	3-Ph Pad	2500	12470GRDY/7200 X 24940GRDY/14400	125/30	480Y/277	42125

Specification reviewed by: _____

Public Works Commission
 Fayetteville, NC
 Electric Systems Division
 Material Specification

TRANSFORMER, PAD-MOUNT, 3-PHASE, 12X24KV

Revision Date: February 7, 2024
 Revised By: Glenn Andersen
 Page 3 of 4

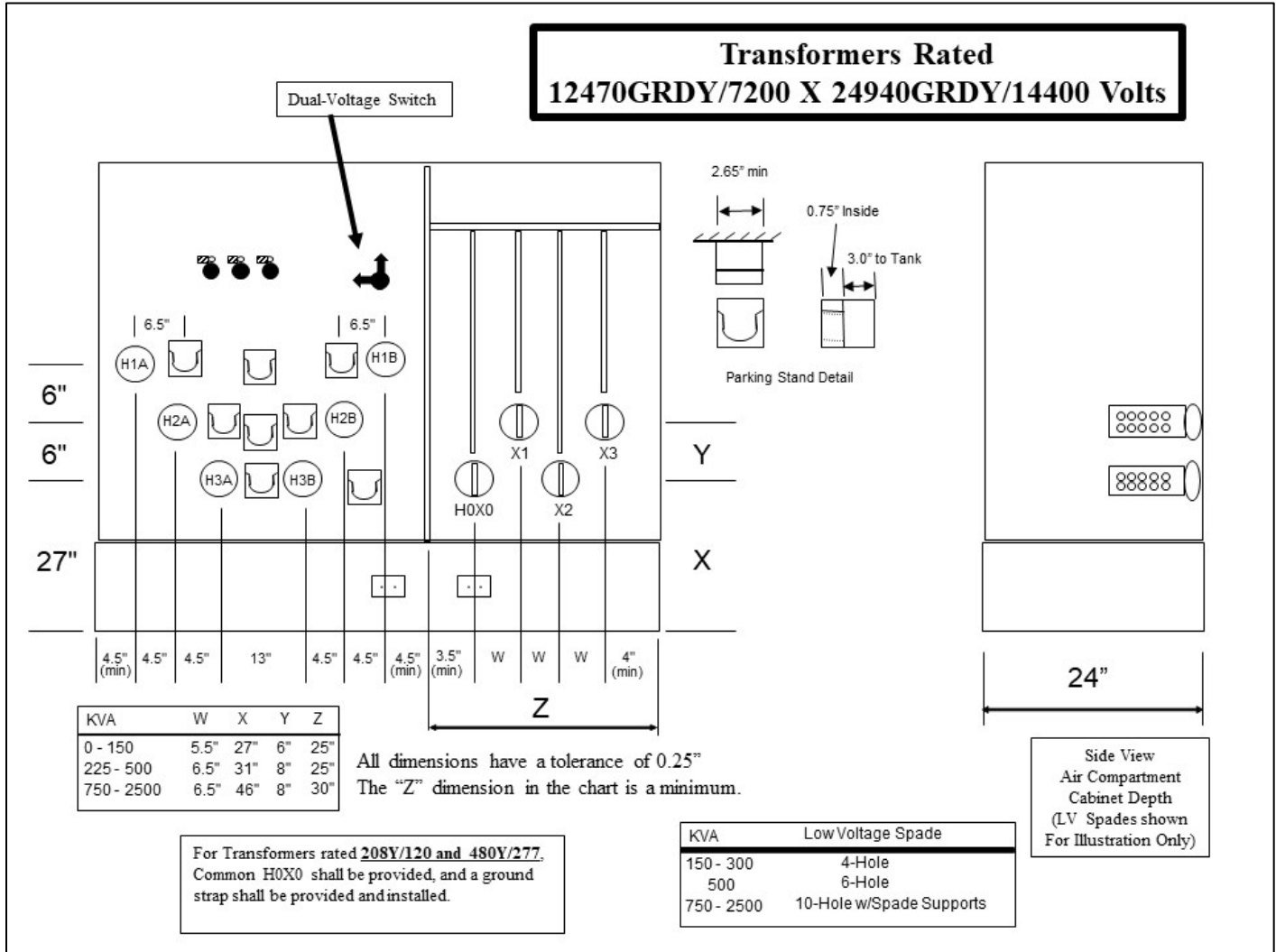

TRANSFORMER, PAD-MOUNT, 3-PHASE, 12X24KV

Revision Date: February 7, 2024

Public Works Commission
Fayetteville, NC
Electric Systems Division
Material Specification

Revised By: Glenn Andersen
Page 4 of 4

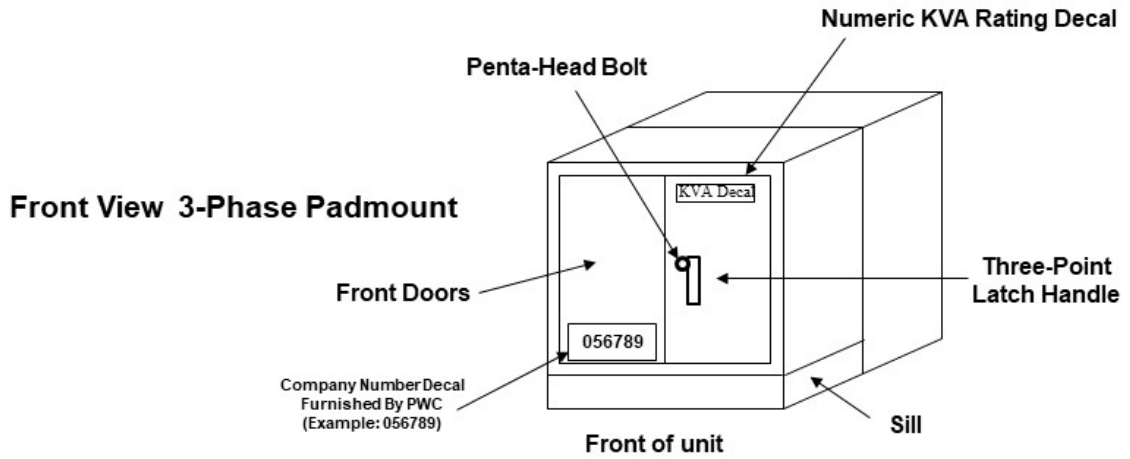

Rear View 3-Phase Padmount

**Duplicate Nameplate Location
for 3-Phase Padmounts**

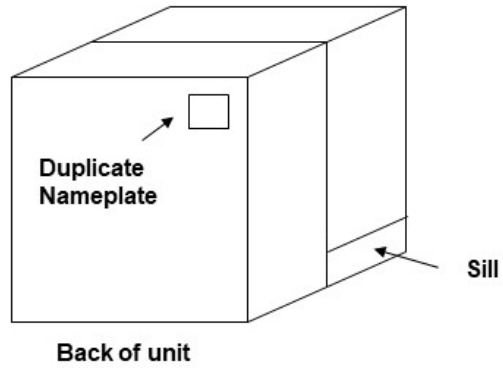

ATTACHMENT B: BID PRICING FORM

Bidder Information:

Name of Company

Address

Phone Number

Email Address

Federal ID No.

**Is the business SDBE,
MWBE, DBE, or HUB
Printed Name**

Title

Signature

Date

Name of Company:

Furnish And Deliver:

Item #	QTY.	UOM	DESCRIPTION	UNIT PRICE	EXTENDED PRICE
1	7	EA	1-295-700 1295 3P Pad 12KV 020724 300 KVA 12470GRDY/7200 – 208Y/120 V (Straight 12KV) Manufacturer:	\$	\$
2	1	EA	1-295-725 1295 3P Pad 12KV 020724 500 KVA 12470GRDY/7200 – 480Y/277 V (Straight 12KV) Manufacturer:	\$	\$
3	6	EA	1-295-740 1295 3P Pad 12KV 020724 750 KVA 12470GRDY/7200 – 480Y/277 V (Straight 12KV) Manufacturer:	\$	\$
4	4	EA	1-295-786 1295 3P Pad 12KV 020724 2500 KVA 12470GRDY/7200 – 480Y/277 V (Straight 12KV With Taps) Manufacturer:	\$	\$
5	3	EA	1-295-701 1295 3P Pad 12X24KV 020724 300 KVA 12470GRDY/7200 – 208Y/120 V (Dual Voltage 12 X 24 KV) Manufacturer:	\$	\$
6	2	EA	1-295-721 1295 3P Pad 12X24KV 020724 500 KVA 12470GRDY/7200 – 208Y/120 V (Dual Voltage 12 X 24 KV) Manufacturer:	\$	\$

TOTAL EXTENDED PRICE: \$ _____

ATTACHMENT C: CERTIFICATION OF PRIMARY PARTICIPANT REGARDING DEBARMENT, SUSPENSION AND OTHER RESPONSIBILITY MATTERS

The Primary Participant, _____ (major third party contractor), certifies to the best of its knowledge and belief, that it and its principals:

1. Are not presently debarred, suspended, proposed for debarment, declared ineligible, or voluntarily excluded from covered transactions by any Federal department or agency;
2. Have not within a three-year period preceding this proposal been convicted of or had a civil judgment rendered against them for commission of fraud or a criminal offense in connection with obtaining, attempting to obtain, or performing a public (Federal, State or local) transaction or contract under a public transaction; violation of Federal or State antitrust statutes or commission of embezzlement, theft, forgery, bribery, falsification or destruction of records, making false statements, or receiving stolen property;
3. Are not presently indicted for or otherwise criminally or civilly charged by a governmental entity (Federal, State or local) with commission of any of the offenses enumerated in paragraph (2) of this certification; and
4. Have not within a three-year period preceding this application/proposal had one or more public transactions (Federal, State or local) terminated for cause or default.

(If the primary participant is unable to certify to any of the statements in this certification, the participant shall attach an explanation to this certification.)

THE PRIMARY PARTICIPANT _____ CERTIFIES OR AFFIRMS THE TRUTHFULNESS AND ACCURACY OF THE CONTENTS OF THE STATEMENTS SUBMITTED ON OR WITH THIS CERTIFICATION AND UNDERSTANDS THAT THE PROVISIONS OF 31 U.S.C. SECTIONS 3801 ET. SEQ. ARE APPLICABLE THERETO.

Signature

Title

Printed Name

Date

PWC At a Glance



Customers



- In operation since 1905 (117 years)
- Provide Electric, Water and Wastewater Services
- Total Customers: 119,788
- Number of Services: 284,395
 - Electric: 82,376
 - Water: 90,548
 - Wastewater: 90,226
- Customers with 2+ services: 75%
- Annual Customer Turnover: 20-25%

Customer Service



- Annual Customer Contacts: 444,622
- Average Monthly Calls: 30,468
- Annual Bills Generated: 1.4 Million
- Customer Incentive Programs: 13
- Annual Water Leak Notifications: 22,476 (19.4 million gal)

Employees



- Number of Employees: 622
 - Average Tenure of Employees: 10.33 years
 - Average Age: 44.77
 - Annual Turnover: 9.6%*
 - Annual Hours Worked: 1.3 Million
- *non retirement

Facilities



- Butler-Warner Generation Plant (268 MW)
- PO Hoffer Water Treatment Facility (39.5 MGD)
- Glenville Lake Water Treatment Facility (18.0 MGD)
- Cross Creek Water Reclamation Facility (25 MGD)
- Electric Service Area: 147 Sq. Miles
- Water Service Area: 115 Sq. Miles
- Wastewater Service Area: 108 Sq. Miles

Electric Operations



- Purchase Wholesale Power from Duke Energy
- Only NC municipal system to own/operate a generation plant (Dispatched for use by Duke Energy)
- Generation Capacity: 268 MW
- Annual MWH Sold: 1.9 Million
- System Peak: 499 MW (Feb. 9, 2015)
- Reliability Rate: 99.97%
- Electric Distribution Substations: 32
- Distribution Lines: 1,351 miles
- Transmission Lines: 123 miles
- Streetlights/Area Lights: 37,580

Water/Wastewater Operations



- Population Served: 225,000
- Drinking Water Treated: 10.6 Billion Gallons/Year
- 100% Compliant for all EPA Drinking Water Standards
- Daily Water Treatment Capacity: 57.5 MG/Day
- Daily Wastewater Treatment Capacity: 46 MG/Day
- Water/Wastewater Infrastructure: 2,772 miles
- Hydrants: 8,423
- Sanitary Sewer Lift Stations: 78
- Manholes: 32,855

Financial



- Annual Operating Budget: \$397.5 Million
- Total Assets: \$1.5 Billion
- Bond Rating: Aa2 (Moody's), AA (Standard & Poor) AA (Fitch)
- Annual Local Purchases: \$9.4 Million
- Operations & Maintenance Expenses per Customer: \$505 (\$557 National Median)
- Annual Cash Contributions to City of Fayetteville in Lieu of Taxes: \$12.4 Million
- Annual Streetlight Services: \$3.9 Million
- Annual Annexation Construction Costs: \$5.9 Million
- Total Annual Contributions to City of Fayetteville: \$24.1 Million

SALE OF GOODS AGREEMENT

This Sale of Goods Agreement (“Agreement”) is made by and between the City of Fayetteville (the “City”), by and through the Fayetteville Public Works Commission (“PWC”), a North Carolina public authority, and _____ [insert seller’s full legal name] (“Seller”), a _____ [identify the legal entity and State in which formation was accomplished] (each of PWC and Seller is a “Party” and both are collectively the “Parties”) as of the date of execution last written below (the “Effective Date”). In consideration of the mutual covenants and agreements contained herein, and other good and valuable consideration, the receipt and sufficiency of which is hereby acknowledged, The Parties agree as follows:

1. Sale of Goods. Seller shall sell to PWC and PWC shall purchase from Seller the following [Identify the goods specifically] (the “Goods”). PWC may issue a purchase order for the Goods that specifies any additional applicable terms and conditions set forth for the purchase (a “Purchase Order”), but such Purchase Order is subject to the terms of this Agreement. In the event of a conflict between the provisions of this Agreement and the provisions of any Contract Documents, attachment, exhibit or Purchase Order made pursuant to this Agreement, the terms of this Agreement shall govern.

2. Contract Documents. “Contract Documents” means, collectively, the following documents that were either made available to Seller by PWC during the bid solicitation process (including Drawings) or executed by the Parties, or both, which are all incorporated by reference herein:

- a. This Agreement
- b. Notice to Prospective Bidders
- c. Definitions
- d. Instructions to Bidders
- e. General Conditions
- f. Materialman’s Proposal
- g. Bid Bond
- h. Technical Specifications
- i. Purchase Order(s)
- j. Addenda

3. Delivery of Goods. Seller shall deliver the Goods [EITHER: “on or before _____” OR “as specified in the Contract Documents or an applicable Purchase Order issued by PWC” OR “as otherwise agreed in writing by the Parties”] (the “Delivery Date”). Timely delivery of the Goods is of the essence. If Seller fails to deliver the Goods on or before the Delivery Date, PWC may, without any liability to Seller, terminate this Agreement immediately by providing written notice to Seller. Unless otherwise specified in an applicable Purchase Order or the Contract Documents, excluding this Agreement, all Goods shall be delivered to PWC’s Warehouse at 955 Old Wilmington Road, Fayetteville, North Carolina 28301 (the “Delivery Point”) during PWC’s normal business hours. Delivery shall be made FOB Delivery Point.

4. Title and Risk of Loss. Title of the Goods passes to PWC upon delivery of the Goods to the Delivery Point. Seller bears all risk of loss or damage to the Goods until delivery of the Goods to the Delivery Point.

5. Packaging. Seller shall properly pack, mark, and ship the Goods as instructed by PWC and otherwise in accordance with applicable law and industry standards and shall provide PWC with all shipment documentation showing the quantity of pieces in shipment, the number of cartons or containers in shipment, Seller's name, the airway bill or bill of lading number, and the state of origin.

6. Inspection and Rejection of Nonconforming Goods. PWC has the right to inspect the Goods on or after the Delivery Date. PWC, at its sole option, may inspect all or a sample of the Goods, and may reject all or any portion of the Goods if it determines the Goods are nonconforming or defective. If PWC rejects any portion of the Goods, PWC has the right, effective upon written notice to Seller, to: (a) terminate this Agreement in its entirety and require Seller to remove the Goods in a commercially reasonable time period or pay the full cost and expense to have the rejected Goods returned to Seller; or (b) reject the Goods and require replacement of the rejected Goods at Seller's sole expense. If PWC requires replacement of the Goods, Seller shall, at its sole expense and in the lesser of ninety (90) days or the number of days between any applicable Purchase Order of PWC and the Delivery Date, replace the nonconforming Goods and pay for all related expenses, including, but not limited to, transportation charges for the return of the defective goods and the delivery of replacement Goods. Any inspection or other action by PWC under this Section shall not reduce or otherwise affect Seller's obligations under this Agreement, including Seller's warranties, and PWC shall have the right to conduct further inspections after Seller has carried out its remedial actions.

7. Price. PWC shall purchase the Goods from Seller in the total amount of \$_____ ("Price"). The Price includes all packaging, transportation costs to the Delivery Location, insurance, fees, and applicable taxes, including, but not limited to, all sales, use, or excise taxes. No increase in the Price is effective, whether due to increased material, labor, transportation costs or otherwise, without the prior written consent of PWC.

8. Billing and Payment. Seller shall invoice PWC within thirty (30) days after the completion of the delivery of the Goods. PWC shall pay the undisputed portion of the invoice within forty-five (45) calendar days after PWC's receipt of the invoice. All payments from PWC to Seller shall be transferred electronically to Seller's designated financial institution, and Seller shall, prior to delivery of its invoice to PWC, supply the name of Seller's financial institution, routing number, and account number on the form available from PWC and provide to PWC a completed and signed IRS Form W-9. Seller has the right to impose a late payment charge of one percent (1%) per month for amounts unpaid by PWC by the date due.

Provider shall comply with all of the following requirements so that PWC may recover the full amount of sales and use tax under North Carolina law permitted under the law:

- a. Furnish PWC documentary evidence showing the material used, sales tax paid, and County paid (County of sale). The documentary evidence shall include Provider's certified statement showing total purchases of materials from each separate vendor and total sales taxes charged to PWC and paid by Provider. The documentary evidence shall also include Provider's certified statement as to the amount paid by PWC for sales tax on the Goods. A certified form is required even if no sales tax was paid for the pay request period. Materials used from Provider's warehouse stock shall be shown in a

- certified statement at warehouse stock prices and amount of County of Use Tax charged to PWC and paid by Provider;
- b. Provider shall furnish to PWC invoices or copies of invoices for all materials purchased for said work within pay request period, and such invoices shall state the amount of North Carolina Sales Tax, if any, paid for the Goods. Provider shall also furnish to PWC invoices identifying the amount paid for the sales and use tax on Services that are subject to such taxation under North Carolina law; and
 - c. Provider shall not include any tax paid on supplies, tools, and equipment that Provider uses to perform its obligations under this Agreement.

9. Warranties. Seller warrants to PWC that for a period of twenty-four (24) months from the Delivery Date, all Goods will: (a) be free from any defects in workmanship, material and design; (b) conform to applicable specifications, drawings, designs, samples and other requirements set forth in the Contract Documents or as specified by PWC and agreed to by Seller; (c) be fit for their intended purpose and operate as intended; (d) be free and clear of all liens, security interests, or other encumbrances; and (e) not infringe or misappropriate any third party's patent or other intellectual property rights. These warranties survive any delivery, inspection, acceptance or payment of or for the Goods by PWC. These warranties are cumulative and in addition to any other warranty provided by law or equity. Any applicable statute of limitations runs from the date of PWC's discovery of the noncompliance of the Goods with the foregoing warranties. If PWC gives Seller notice of noncompliance with this Section 9, Seller shall, at its own cost and expense, within thirty (30) days replace or repair the defective or nonconforming Goods and pay for all related expenses, including, but not limited to, transportation charges for the return of the defective or nonconforming goods to Seller and the delivery of repaired or replacement Goods to PWC.

10. Termination. Notwithstanding any other or additional remedies that may be provided under this Agreement, PWC may terminate this Agreement with immediate effect upon written notice to the Seller, either before or after the acceptance of the Goods, if: (a) Seller repudiates, or threatens to repudiate, any of its obligations under this Agreement; (b) Seller is in breach of, or threatens to breach, any representation, warranty, or covenant of Seller under this Agreement and either the breach cannot be cured or, if the breach can be cured, it is not cured by Seller within a commercially reasonable period of time under the circumstances, in no case exceeding seven (7) days following Seller's receipt of Notice of such breach; (c) Seller fails to, or threatens to fail to, timely deliver Goods conforming to the requirements of, and otherwise in accordance with, the terms and conditions of this Agreement; or (d) Seller becomes insolvent, files a petition for bankruptcy, or commences or has commenced against it proceedings relating to bankruptcy, receivership, reorganization, or assignment for the benefit of creditors. PWC shall be obligated to pay Seller only for work performed and reasonable expenses incurred until delivery of the notice of termination.

11. Insurance. During the term of this Agreement and for a period of three (3) years after the date of this Agreement, Seller shall, at its own expense, maintain and carry insurance in full force and effect that includes, but is not limited to, commercial general liability (including product liability) with limits no less than \$1,000,000 for each occurrence and \$3,000,000 in the aggregate and umbrella liability in a sum no less than \$5,000,000, which insurance shall be placed with insurance companies authorized to do business in the State of North Carolina and rated A minus VII or better by the current edition of Best's Key Rating Guide or otherwise approved in writing by PWC. Prior to delivering any Goods, Seller shall deliver to PWC

certificates of insurance confirming each such coverage, and Seller shall direct its insurers to provide annually to PWC certificates confirming each such coverage during the coverage period. PWC shall be named as an additional insured in the insurance policy. Seller shall not reduce or allow the required insurance coverages to lapse without PWC's prior written approval. All policies for insurance must be endorsed to contain a provision giving PWC a thirty (30) calendar day prior written notice by certified mail of any cancellation of that policy or material reduction in coverage. Should a notice of cancellation be issued for non-payment of premiums or any part thereof, or should Seller fail to provide and maintain certificates as set forth herein, PWC shall have the right, but not the obligation, to pay such premium to the insurance company or to obtain such coverage and to deduct such payment from any sums that may be due or become due to Seller, or to seek reimbursement for said payments from Seller. Any such sums paid by PWC shall be due and payable immediately by Seller upon notice from PWC. The insurance provisions of this Agreement shall not be construed as a limitation on Seller's responsibilities and liabilities pursuant to the terms and conditions of this Agreement.

12. Indemnification. Seller shall indemnify, defend, and hold harmless PWC and its Commissioners, officers, employees, agents, and representatives (collectively, "Indemnitees") from and against all claims, actions, liabilities, damages, losses, costs, and expenses (including, without limitation, injury to or death of any persons and damage to property, economic and consequential damages and attorneys' fees) asserted by one or more third parties against one or more of the Indemnitees arising out of negligent or willful acts, violations of law, infringement of any patent, trademark, trade secret, copyright, or other intellectual property right of a third party, or omissions or breach of the obligations set forth in this Agreement by Seller or any of its employees, agents, representatives, and subcontractors. Seller's obligation to indemnify, defend, and hold harmless the Indemnitees shall survive the termination of this Agreement and shall include the duty to pay for the reasonable attorney's fees and costs associated with defending the Indemnitee(s) by the legal counsel of each Indemnitee's choice.

13. Notices. Any notice which either Party is required or desires to give the other shall be deemed sufficiently given if, in writing, it is delivered personally, or sent by certified U.S. mail, return-receipt requested, postage prepaid, to the addresses listed hereinbelow, or such other address as either Party shall give to the other Party by written notice in accordance herewith. Any notice given herein by personal delivery shall be deemed delivered when received. Any properly addressed notice given herein by certified mail shall be deemed delivered on the third Business Day after the same is deposited in an official United States Post Office, postage prepaid, or if sooner upon the date when the return receipt therefor is signed, or refusal to accept the mailing by the addressee is noted thereon by the postal authorities.

To PWC:
Fayetteville Public Works Commission
Attn: Timothy Bryant, CEO/General Manager
PO Box 1089
Fayetteville, NC 28302

To Seller:
[INSERT MAILING ADDRESS]

14. Compliance. Seller hereby acknowledges that "E-Verify" is the federal E-Verify program operated by the US Department of Homeland Security and other federal agencies which is used to verify the work authorization of newly hired employees pursuant to federal law

and in accordance with Article 2, Chapter 64 of the North Carolina General Statutes. Seller further acknowledges that all employers, as defined by Article 2, Chapter 64 of the North Carolina General Statutes, must use E-Verify and after hiring an employee to work in the United States, shall verify the work authorization of the employee through E-Verify in accordance with NCGS §64-26(a). Seller hereby pledges, attests, and warrants through execution of this Agreement that Seller complies with the requirements of Article 2, Chapter 64 of the North Carolina General Statutes and further pledges, attests, and warrants that all subcontractors currently employed by or subsequently hired by Seller to provide services for PWC shall comply with all E-Verify requirements. Failure to comply with the above requirements shall be considered a breach of this Agreement. Seller hereby further acknowledges that the execution and delivery of this Agreement constitutes Seller's certification to PWC and to the North Carolina State Treasurer that, as of the Effective Date, Seller is not listed on (a) the Final Divestment List created and maintained by the North Carolina Department of State Treasurer pursuant to the Iran Divestment Act of 2015, Chapter 147, Article 6E of the General Statutes of North Carolina (the "Iran Divestment Act"); or (b) the list of companies that the North Carolina State Treasurer determines to be engaged in a boycott of Israel in accordance with Article 6G of Chapter 147 of the General Statutes of North Carolina. Seller represents and warrants to Commission that Seller, and all persons and entities owning (directly or indirectly) an ownership interest in it: (i) are not, and will not become, a person or entity with whom a party is restricted from doing business with under regulations of the Office of Foreign Asset Control ("OFAC") of the Department of the Treasury (including, but not limited to, those named on OFAC's Specially Designated and Blocked Persons list) or under any statute, executive order (including, but not limited to, the September 24, 2001, Executive Order 13224 Blocking Property and Prohibiting Transactions with Persons Who Commit, Threaten to Commit, or Support Terrorism), or other governmental action; and (ii) are not knowingly engaged in, and will not knowingly engage in, any dealings or transactions or be otherwise associated with such persons or entities described in clause (i) above. Seller also shall at all times during the term of this Agreement comply with Executive Order 11246, including but not limited to the Equal Opportunity Clause requirements set forth in 41 C.F.R. § 60-1.4. Seller shall abide by the requirements of 41 CFR 60-300.5(a) and 60-741.5(a) prohibiting discrimination against qualified individuals on the basis of protected veteran status or disability and requiring affirmative action by covered prime contractors and subcontractors to employ and advance in employment qualified protected veterans and individuals with disabilities.

15. Cumulative Remedies. All rights and remedies provided in this Agreement are cumulative and not exclusive, and the exercise by either Party of any right or remedy does not preclude the exercise of any other rights or remedies that may now or subsequently be available at law or in equity.

16. Miscellaneous Provisions. Seller is and shall remain an independent contractor. Nothing contained in this Agreement shall be deemed or construed to create the relationship of principal and agent or of partnership or of joint venture or of any association whatsoever between the Parties. No breach or non-performance of any term of this Agreement shall be deemed to be waived by either Party unless said breach or non-performance is waived in writing and signed by the Parties. No waiver of any breach or non-performance under this Agreement shall be deemed to constitute a waiver of any subsequent breach or non-performance, and for any such breach or non-performance each Party shall be entitled to such remedies as provided by law. No consent or waiver by a Party shall be effective unless it is in writing and then only to the extent specifically stated. The invalidity, illegality, or un-enforceability of any portion or provision of this Agreement shall in no way affect the validity, legality, and/or enforceability of

any other portion or provision of this Agreement. Any invalid, illegal, or unenforceable provision of this Agreement shall be deemed severed from this Agreement, and the balance of the Agreement shall be construed and enforced the same as if the Agreement had not contained any portion or provision which was invalid, illegal, or unenforceable; provided, however, severability shall not prevent this entire Agreement from being void in the event any portion or provision of this Agreement that is of the essence of this Agreement shall be void. This is the entire agreement of the Parties on the subject matter hereof, and all prior negotiations, representations, proposals, letters, agreements, understandings, or other communications between the Parties, whether written or oral, are hereby merged into the Agreement and superseded by this Agreement. This Agreement shall not be modified unless such modifications are evidenced in writing, signed by both Parties. Nothing herein shall be construed to give any right or benefits hereunder to anyone other than the Parties. This Agreement shall be governed by the laws of the State of North Carolina without the application of the laws of any other state. The exclusive venue for all mediations and litigation and any other legal proceedings regarding this Agreement shall be the State and Federal Courts serving Cumberland County, North Carolina, and Seller consents to personal jurisdiction in such courts. Seller irrevocably waives, to the fullest extent permitted by law, any objection that it may now or hereafter have to the laying of the venue of any such suit, action or proceeding in any such court serving Cumberland County or that any such suit, action or proceeding brought in any such court serving Cumberland County has been brought in an inconvenient forum. This Agreement may be executed in counterparts with the same effect as if the signatures to each counterpart were upon a single instrument, and all such counterparts together shall be deemed an original of this Agreement. For purposes of this Agreement, a facsimile copy or scanned copy or photocopy of a party's signature shall be sufficient to bind such party. This Agreement shall be subject to execution by electronic means in accordance with Article 40 of Chapter 66 of the North Carolina General Statutes. The titles of the paragraphs throughout this Agreement are for convenience only and the words contained therein shall in no way be held to explain, modify, amplify, or aid in the interpretation, construction, or meaning of the provisions of this instrument.

17. Conflicts. Except with PWC's knowledge and prior written consent, the Seller shall not engage in any activity or accept any employment, interest or contribution that would reasonably appear to compromise the Seller's professional judgment with respect to the Goods. The Seller shall disclose to PWC any business or personal relationship with any Commissioner, officer, director, manager, or supervisor of PWC.

IN WITNESS WHEREOF, the Parties have executed this Agreement by their duly authorized representatives as of the Effective Date.

Fayetteville Public Works Commission

[INSERT SELLER'S FULL LEGAL NAME]

By: _____
Timothy Bryant, CEO/General Manager

By: _____
(Printed Name), (Title)

Date: _____

Date: _____

This instrument has been preaudited in the manner required by the Local Government Budget and Fiscal Control Act (N.C. Gen. Stat. § 159-1 et seq.).

By: _____
Rhonda Haskins, Chief Financial Officer

Approved as to form:

Legal Dept.

SAMPLE

**FAYETTEVILLE PUBLIC WORKS COMMISSION'S
MWDBE COMPLIANCE PROVISIONS**

APPLICATION:

The requirements of Fayetteville Public Works Commission (PWC) Minority, Women, and Disadvantaged Business Enterprise (MWDBE) Program for participation specific contracts are hereby made part of the Contract Documents. Copies of the Program may be obtained from:

Fayetteville Public Works Commission
Economic Inclusion Programs
P.O. Box 1089
Fayetteville, North Carolina 28302
Phone (910) 223-4016 Fax (910) 483-1429
E-mail: EIProgram@faypwc.com

NCDOT DBE Directory: www.ebs.nc.gov/VendorDirectory

HUB Directory: <https://ncadmin.nc.gov/businesses/hub>

MWDBE Compliance Requirements:

1. The Bidder shall provide, with their Bid Form, at the time bids are due, the documents set forth below, properly executed. Returning executed copies indicates and establishes that the Bidder understands and agrees to any incorporated MWDBE contract provisions.
2. All Bidders must provide with their Bid Form, at the time bids are due, a properly completed and executed copy of **either:**
 - Affidavit A – Listing of Good-Faith Efforts **OR**
 - *Affidavit B – Intent to Self-Perform with Own Workforce.

*Affidavit B should **only** be used if the Contractor will perform **ALL Elements** of the Work on this project with their own forces **AND** will complete **ALL Elements** of this project **WITHOUT** the use of subcontractors, material suppliers, or providers of professional services.
3. Upon being identified as the apparent lowest responsive, responsible Bidder, a Bidder shall, within twenty-four (24) hours of PWC's notification provide a properly completed and executed copy of **either:**
 - Affidavit C – Percentage of MWDBE Participation **OR**
 - Affidavit D – Good-Faith Efforts.
4. All Bidders must provide with their Bid Form, at the time bids are due, a properly completed and executed copy of Affidavit E- Identification of MWDBE/Local Participation Form

All written statements, certifications, or intentions made by the Bidder shall become a part of the agreement between the Contractor and Fayetteville Public Works Commission for performance of this contract.

SUBCONTRACTOR PAYMENT REQUIREMENTS:

North Carolina General Statutes 143-134.1 (N.C.G.S.) states that the percentage of retainage on payments made by the prime contractor to the subcontractor shall not exceed the percentage of retainage on payments made by the Fayetteville Public Works Commission to the prime contractor. Failure to comply with this provision shall be considered a breach of the contract, and the contract may be terminated in accordance with the termination provisions of the contract.

The Contractor shall provide an itemized statement of payments to each MWDBE subcontractor before final payment is processed.

The Contractor shall provide an itemized statement of payments to each NON-MWDBE subcontractor before final payment is processed.

Contractor

Signature

Printed Name

Title

Date

Affidavit A: Listing of the Good Faith Efforts

Affidavit of _____
(Name of Bidder)

I have made a good faith effort to comply under the following areas checked:

<i>Total Available GFE Points: 155</i>		<i>Minimum Number GFE Points Required: 50</i>
Points		
10	10	Contacting minority businesses that reasonably could have been expected to submit a quote and that were known to the contractor or available on State or local government-maintained lists at least 10 days before the bid or proposal date and notifying them of the nature and scope of the work to be performed.
10	10	Making the construction plans, specifications and requirements available for review by prospective minority businesses or providing these documents to them at least 10 days before the bid or proposals are due.
15	15	Breaking down or combining elements of work into economically feasible units to facilitate minority participation.
10	10	Working with minority trade, community, or contractor organizations identified by the Office for Historically Underutilized Businesses and included in the bid documents that provide assistance in recruitment of minority businesses.
10	10	Attending any pre-bid meetings scheduled by the public owner.
20	20	Providing assistance in getting required bonding or insurance or providing alternatives to bonding or insurance for subcontractors.
15	15	Negotiating in good faith with interested minority businesses and not rejecting them as unqualified without sound reasons based on their capabilities. Any rejection of a minority business based on lack of qualification should have the reasons documented in writing.
25	25	Providing assistance to an otherwise qualified minority business in need of equipment, loan capital, lines of credit, or joint pay agreements to secure loans, supplies, or letters of credit, including waiving credit that is ordinarily required. Assisting minority businesses in obtaining the same unit pricing with the bidder's suppliers in order to help minority businesses in establishing credit.
20	20	Negotiating joint venture and partnership arrangements with minority businesses in order to increase opportunities for minority business participation on a public construction or repair project when possible.
20	20	Providing quick pay agreements and policies to enable minority contractors and suppliers to meet cash-flow demands.
Total GFE Points (Claimed by Bidder):		Total GFE Points (Assessed by PWC):

In accordance with NCGS 143-128.2(d) the undersigned will enter into a formal agreement with the firms listed in the Identification of Small Disadvantaged Business Participation schedule conditional upon execution of a contract with the Owner. Failure to abide by any applicable statutory provision may constitute a breach of the contract. The undersigned hereby certifies that he or she has read the terms of the MWDBE business commitment and is authorized to bind the Bidder to the commitment herein set forth.

Date: _____ Name of Authorized Officer: _____

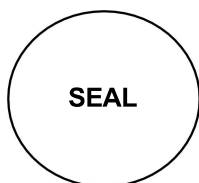

State of North Carolina, County of _____

Subscribed and sworn to before me this _____ day of 20__

Notary Public _____

My commission expires _____

Affidavit B: Intent to Perform Contract with Own Workforce

Affidavit of _____
(Name of Bidder)

I hereby certify that it is our intent to perform 100% of the work required for contract:

(Name of Project)

In making this certification, the Bidder states that the Bidder does not customarily subcontract elements of this type project, and normally performs and has the capability to perform and will perform **all elements of the work** on this project with his/her own current workforces; and will complete all elements of this project **without** the use of subcontractors, material suppliers, or providers of professional services.

The Bidder agrees to provide any additional information or documentation requested by the Owner in support of the above statement.

The undersigned hereby certifies that he or she has read this certification and is authorized to bind the Bidder to the commitments herein contained.

Date: _____ Name of Authorized Officer: _____

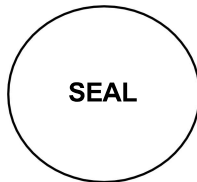

State of North Carolina, County of _____

Subscribed and sworn to before me this _____ day of 20____

Notary Public _____

My commission expires _____

Affidavit C: Percentage of MWDBE Participation

Affidavit of _____
(Name of Bidder)

I hereby certify that on contract: _____
(Name of Project)

\$ _____
(Dollar Amount of Total Bid)

I will expend a minimum of _____% of the total dollar amount of the contract with Minority, Women, and Disadvantaged Business Enterprises (MWDBE). MWDBEs will be employed as subcontractors, vendors, or providers of professional services. Such work will be subcontracted to the following firms listed below.

<u>Name, Address, & Phone No.</u>	<u>*MWDBE Category</u>	<u>NAICS</u>	<u>Dollar Value</u>	<u>% of Contract</u>

*MWDBE categories: Black-African Americans (B), Hispanic-Americans (H), Asian- Americans (A), Native-Americans (I), Women (F), Socially/Economically Disadvantaged (D)

Pursuant to NCGS 143-128.2(d), the undersigned will enter into a formal agreement with MWDBEs for work listed in this schedule conditional upon execution of a contract with the Owner. Failure to fulfill this commitment may constitute a breach of the contract.

The undersigned hereby certifies that he or she has read the terms of this commitment and is authorized to bind the Bidder to the commitment herein set forth.

Date: _____ Name of Authorized Officer: _____

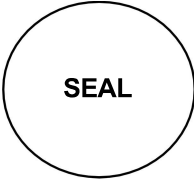

State of North Carolina, County of _____
Subscribed and sworn to before me this _____ day of 20____
Notary Public _____
My commission expires _____

Affidavit D: Good Faith Efforts

If Owner determines using reasonable discretion that Affidavit C is insufficient, Bidder agrees to provide the following information regarding any good-faith efforts.

<u>Name, Address, & Phone No.</u>	<u>*MWDBE Category</u>	<u>NAICS</u>	<u>Dollar Value</u>

*MWDBE categories: Black-African Americans (B), Hispanic-Americans (H), Asian- Americans (A), Native-Americans (I), Women (F), Socially/Economically Disadvantaged (D)

Bidder may be requested to provide documentation of the Bidder’s good-faith efforts. Examples of documentation may include the following:

- a. Copies of solicitations for quotes to MWDBEs. Each solicitation may include a specific description of the work to be subcontracted, location where bid documents can be reviewed, representative of the Prime Bidder to contact, and location, date and time when quotes must be received.
- b. Copies of quotes or responses received from each firm responding to the solicitation.
- c. A telephone log of follow-up calls to each firm sent a solicitation.
- d. For subcontracts where a MWDBE is not considered the lowest responsible sub- bidder, copies of quotes received from all firms submitting quotes for that particular subcontract.
- e. Documentation of any contacts or correspondence to MWDBE, community or contractor organizations in an attempt to meet the goal.
- f. Copy of pre-bid roster.
- g. Letter documenting efforts to provide assistance in obtaining required bonding or insurance for MWDBEs.
- h. Letter detailing reasons for rejection of a MWDBE due to lack of qualification.
- i. Letter documenting proposed assistance offered to MWDBEs in need of equipment, loan capital, lines of credit, or joint pay agreements to secure loans, supplies, or letter of credit, including waiving credit that is ordinarily required.

Failure to provide the documentation as listed in these provisions may result in rejection of the bid and award to the next lowest responsible and responsive Bidder.

Date: _____ Name of Authorized Officer: _____

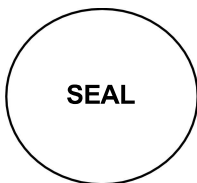

State of North Carolina, County of _____
 Subscribed and sworn to before me this _____ day of 20____
 Notary Public _____
 My commission expires _____

Affidavit E: Identification of MWDBE/Local Participation

(Name of Bidder)

I hereby certify that on contract: _____

(Name of Project)

We will use the following Minority, Women, and Disadvantaged Business Enterprises (MWDBE), and Local (Cumberland, Hoke, Harnett County) as construction subcontractors, vendors, suppliers, or providers of professional services.

<u>Name, Address, & Phone No.</u>	<u>*MWDBE Category / **Local</u>	<u>NAICS</u>	<u>Dollar Value</u>

*MWDBE categories: Black-African Americans (B), Hispanic-Americans (H), Asian- Americans (A), Native-Americans (I), Women (F), Socially/Economically Disadvantaged (D)

**Local: Fayetteville Metropolitan Statistical Area (MSA) comprising of Cumberland County, Hoke County, and Harnett County. PWC is requesting this information for reporting purposes only, and use of local entities will not be considered for compliance with the requirements of the MWDBE Program.

The total value of MWDBE/local business contracting will be \$ _____

Date: _____ Name of Authorized Officer: _____

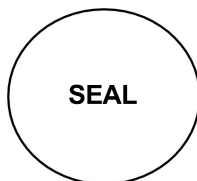

State of North Carolina, County of _____

Subscribed and sworn to before me this _____ day of 20__

Notary Public _____

My commission expires _____

**FAYETTEVILLE PUBLIC WORKS COMMISSION
MWDBE ADD / CHANGE FORM**

If a MWDBE subcontractor fails to complete work under the subcontract for any reason, the recipient must require the prime contractor to employ the good faith efforts set forth in the MWDBE Program if soliciting a replacement or additional subcontractor.

For MWDBE Change Request, please provide all information below:

Prime Contractor: _____

Subcontracted Work: _____

Previous Subcontractor: _____

Reason this for change request:

New Subcontractor: _____ MWDBE Category: _____

To Add MWDBE Subcontractor/Subcontracted work:

If this is a new trade being subcontracted or a subcontractor that was not documented in the original Project Bid Information submittal, then good faith efforts to solicit a MWDBE must be documented, as the original MWDBE instructions indicate. Please provide all good faith efforts below showing all the MWDBE firms contacted to perform this work along with any additional good faith efforts or evidence that there are not reasonably available firms in the work area. PWC's MWDBE Program requires that good faith efforts are to be carried out to the fullest extent practicable. If solicitations were not carried out due to being impracticable, please attach this explanation to this form.

Name, Address, & Contact Information	MBE or WBE and Certifying agency	How was this firm contacted (email, letter, or Phone) and what was the result of the solicitation? *

*Must submit copies of emails or letters. If phone calls were made this sheet can serve as documentation of calls

Date: _____ Name of Authorized Officer: _____

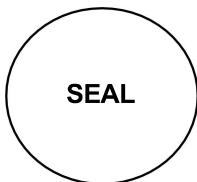

State of North Carolina, County of _____
 Subscribed and sworn to before me this _____ day of 20____
 Notary Public _____
 My commission expires _____

SMALL LOCAL SUPPLIER / MWDBE SUBCONTRACTOR DISCLOSURE FORM

Contractor: _____
 Address & Phone: _____
 Project: _____
 Name: _____
 Pay Application # _____

Please complete the below form by providing the necessary information for the payments made to each subcontractor, vendor, or supplier for the work associated with the identified pay application. This form must be fully completed and attached to each pay application.

Firm Name, Address, and Contact Information	Payment Amount	Type of Work/Commodity (Include NAICS Code)

Signature

Printed Name

Title

Date

